

FLOWING EXPERTISE

2024



# GENERAL PRODUCT GUIDE



## **COMPONENTS FOR CENTRAL HEATING SYSTEMS**

---

### **AIR AND DIRT SEPARATION DEVICES**

---

### **VALVES AND ACCESSORIES FOR RADIATORS**

---

### **ZONE AND MOTORISED VALVES, DISTRIBUTION MANIFOLDS, BOXES AND ACCESSORIES**

---

### **RADIANT PANEL SYSTEM CONTROL**

---

## **COMPONENTS FOR DOMESTIC WATER SYSTEMS**

---

### **BACKFLOW PREVENTION DEVICES**

---

### **BALANCING AND CONTROL DEVICES**

---

### **FITTINGS**

---

### **GAS SAFETY**

---

### **EXPANSION VESSELS, CHRONO-THERMOSTATS, THERMOSTATS**

---

### **HEAT SYSTEMS**

---

## **COMPONENTS FOR RENEWABLE ENERGY SYSTEMS**

---

**SPARE PARTS** - For spare parts, please contact the appropriate department

---

**FITTING COUPLING - PRODUCT DIMENSIONS** are available on [www.caleffi.com](http://www.caleffi.com)

# GENERAL INDEX

SERIES	Page	SERIES	Page	SERIES	Page	SERIES	Page
100	264	258	333	383	101-109-137	5230 ●	192
103 ●	259	259 ●	330	384	109-137	5231	192
108	44	262	340	385	137	524 ●	193
110	344-345	2620	335	386	137-139-152	525	221
112	345	263	341	3871	109	5261	219
116	202-203-204-205	264	338	3872	91	5265	219
120	255	265	339	391	132-135-152	527 EST	10
121	252	278 ●	329	391...S1	155	528	218
125	256	278HE	328	392	138	5280	218
126	252	279HE	328	4001	96-98-100	5281	218
127	251	280	350	4003	96-98-100	529	349
128	251	281	351	4004	96-98-100	530	14
130	240	3006	18	4005	105	531	15
130 <sub>≥ DN 65</sub> ●	240	3010	112	401	86	5320	14
130 ●	240-263	3011	112	402	86	5321	14
132	49-241	3012	112	411	104	5322	14
132 <sub>≥ DN 65</sub> ●	241	3013	112	412	104	5327	14
140	262-264	3015	112	421	87	533	174
140 <sub>≥ DN 65</sub> ●	262	302	17	422	87	533...H	174
142	240-262	3037	222-234	425	87	5330	175
14501 ●	245-249	3038	222-234	426	87	5330..H	176-177
145 <sub>≥ DN 40</sub> ●	246	3040	224	431	86-104	5331	174
145	244	3041	235	432	86-104	5331..H	176
146 ●	246	3045	235	437	101-110-111	5332	174
149	247-250	3046	235	438	110-111	5332..H	176
1520 ●	36-272-298	3047	235	439	110	5334	174
161 ●	36-164-272-298-309	3048	235	446	140	5334..H	176
165	31-34	305	17-48	447	110	5335..H	177
166	32-35	309	15-220-334	4490	88	5335..HS	181
167	33	311	11-13	4496	108	5336	175
171	162	312	11	4499	102	5336..H	177
182	148-158-159-160-161	313	11-13	4501	107	5337	175
200	92-101	314	11	452	107-108	5337..H	177
201	92	315	20	453	108	5338	175
202	93	319 ●	219	454	108	5338..H	177
203	93	3230	222-234	455	106	5339	175
204	92	324	233	456	107	534	220
205	97-99	327	16	459	108	5350	178
209	93-97-99-101	328	108	472 ●	93	5350..H	179
215	94-95-97-99	332	222-234	475	93	5351	178
220	88	333	222-234	501	67	5360	180-181
221	88	334	222-234	5020	50-51-66-155	5362	180
222	88	336	17	5021	66	5365	180
223	88	337	69	5022	67	5366	180
224	88	338	86-102	5024	67	537	180
225	89	3380	101	5025	67	5370	221
226	89	339	86	5026	67	538	21-264
227	88	340	104	5027	67	539	179
230	90	341	104	503 ●	23	539..H	182
230100 ●	91	342	86-102-104	504	68	539H	183-190
231	90	343	86-104	505	69	542	348
232	90	347	140-141	5054	69	543	348
233	90	347...S1	155	5055	69	544	349
234	90	348	107	507	68	5450	60
237	90	349	128-129	5080	69	5453	48-57-61
240	330	350	128	5081	69	5457	62
250	326	351	129	510	16	5459	58-59-80
251	326-327	354	130-216	5121	13	546	78
2521	336	356	131	513	12	5461	77
2522	337	357	131	514	12	5463	63
2523 ●	336	359	208-209-210-211-212-213-214-215-216	518	16-49-263	5464	48-77
2527	337	360	142-216	519	16-34-49-263	5466	63
253	326	361	142	520	186-190-191	547	16
2540	332	362	142	5200	190	547 <sub>≥ DN 100</sub> ●	16
2543	332	363	142	5201	191	548	24
2544	332	364	162	5202	165	5485	50-51
2545	332	364	162	521	186	5495	25
2546	332	3640	131	5212	189	550	28-29-30
2547	332	3641	131-216	5213	188-189	551	71-72-74-75
2548	332	3642	131-138-216	5217	188	5516	47-73
255	330	3642..S1	155	5218	187	5520	10
255 ●	329-330	381	109	5219	187	552080 ●	10
		382	109-137	522	186	5521	10

# GENERAL INDEX

SERIES	Page	SERIES	Page	SERIES	Page	SERIES	Page
553	18	633	125	70009	306	871	281-345
554	18	635	125	7001	307-308	875	279
5557 •	221-296	636	266-267	700105	307	876	279
556 •	296	6370 •	35-269	700105 002	307	877	285
5560 •	23	638	45-122-123-271	700105 003	307	878	285
557 •	23-182	639	268	7002	302-304	879	285
558	20-297	641	126	700205	302	886	285
5580	20-297-330	642	126	700205 002	302	887	285
559	26-27-29-30	643	126	700205 003	302	888 •	280
560	69-109	6440	45-119	700255...	303	890	284
561	68	6442	118	70026	304	891	284
5620	68	6443	118-335	70028	304	893	284
5621	68	6443...3BY	119	70029	304	894	284
5622	68	6444	119	7003	303	900	276
568 •	296	6445	45	7004	302	903	276
570	229	6450	120-121	738	299	904	276
570 ≥ DN 50 •	230	6452	120	739	229	9050	276
5709 •	81-82	6453	121	75025	333	9057	277
572	228	6459	121	7504	319	9058	277
572120	315	6480	191	7507	319	9060	277
573	228	650	130	750811	319	9067	277
573001	19	6509	219	7550 •	199	9068	277
574	228-229	6561	103-124-136-168	755810	319	910	278
574000	19	6562	103-124-136-168	765	309	913	278
574001	19	6563	103-124-136-168	766	309	914	278
574011	19	6564	103-124-136-168	767	309	930	275-277
575	229	6565 •	245-249-302-303	789	315-316	936	109
575 ≥ DN 150 •	230	6566 •	245-249-302-303	789023	315	940	275
5750 •	84	657	138	789100	315	941	275
576 •	181	658	133-143-149-150-155-162	789110	315	942	109-275
577	46-56	659	143-169	789832	315	943	275
577 •	37-230	660	169	789833	315	944	275
578 •	181	661	161-162-169	7940	320	945	275
579 •	37-230	662	132-133-149-152	7941	320	946	275
5790	64	6620	133	7942	320	947	275
580 •	84-232	6621	133	7945	315	948	275
580010	19	663	134-135	7949	317-318	960	282
580011	19-83	6630	135	796	311	961	282
580020	83	6631	135	797	316	962	282
583	139	664	52-150-153	798	321	963	282
584	139	665	151	799	310	964	282
585	139	666...S1	154	837 •	291	966	283
586	139	667...S1	154	838 •	292	967	283
588	274-332	668...S1	154-155	839 •	291	968	283
5881	274	669	138	841 •	289	970	283
592	128-129	671	148	842 •	289	975	282
598	129	675	148-152-160-162	8460 •	289	980	283
5991	138-216	676	124	8461 •	289	986	283
5993	138-216	677	124	847 •	288	R59681	68
5994	138	678	124	848 •	288	R59720	68
5995	138	679	110-111-140-141	850 •	288	SATK10	315
5996	133-138-149-150-155	679 •	111-214	852 •	289	SATK15	316
6000	194-196-197-198-199	680	140-141-152	8540 •	290	SATK16	316
6001	196	681	101-110-111	8541 •	291	SATK201	312
6002 •	201	687 •	23	855 •	293	SATK202	312
6005	200	688 •	23-138	8561 •	292	SATK203	313
603	223	689 •	23	8562 •	292	SATK204	313
609	334	690 •	21	8563 •	293	SATK221	312
610 •	269-270	691 •	21	8565 •	293	SATK222	312
611 •	270	692 •	21	860	279	SATK223	313
612 •	271	693 •	21	860 ≥ DN 75 •	279	SATK224	313
613 •	22-297	694	21	861	279	SATK30	314
618 •	299	7000	305-306-308	861 ≥ DN 75 •	279	SATK32	314
620 •	299	700005	305	862	280	SATK40	314
6205 •	168-299	700005 002	305	863	280	SATK501	317
621 •	22	700005 003	305	863 ≥ DN 75 •	280	SATK502	317
622 •	22	700009	320	864	280	SATK503	317
623 •	22	700025	302-305-307	865	280	SATK60	318
624 •	22	70005	320	866	281		
625 •	22-297	70006	306	867	281		
626	20	700075	305-307	868	281		
630	125	70008	306	869	281		
632	125			870	281		

# THE CALEFFI GREEN



## OUR SUSTAINABLE COMMITMENT

The Caleffi Green means facing a future capable of sustaining the needs of today's and tomorrow's people in terms of climate, sustainable comfort, energy saving and the protection of water and people's health.

**WASTE  
RECOVERY  
AND MORE**

**85 %**  
RAW MATERIALS  
FROM ITALY

**98,7 %**  
RAW MATERIALS  
FROM EUROPE



**100 %**  
EXPANDED POLYURETHANE  
ELIMINATED  
FROM PRODUCT PACKAGING

**+11 %**  
USE OF  
LOW LEAD BRASS  
IN 5 YEARS

**-60 %**  
POLYETHYLENE  
FOR OUTGOING  
PACKAGING

**98.5 %**  
PLASTIC  
SCRAP  
RECOVERED



**100 %**  
BRASS  
SCRAP  
RECOVERED

WATCH  
THE VIDEO



**SAVE  
RESOURCES  
PROTECT  
OUR PLANET**

Our products contribute to  
**GREEN REVOLUTION**  
deliver the right climate for life.

**OUR SOLUTIONS**

**SUPPORTING  
ENERGY  
TRANSITION**



**HEAT PUMP COMPONENTS**

**BETTER WATER  
MANAGEMENT**



**WATER TREATMENT DEVICES**

**SMART DESIGN**



**CIRCUIT BALANCING DEVICES**

**WE CARE  
FOR WATER  
AND PEOPLE'S  
HEALTH**



**DOMESTIC WATER DEVICES**

**SUSTAINABLE  
COMFORT**

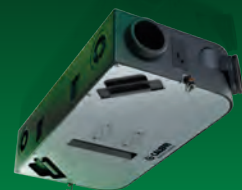

**HRV AND HVAC SYSTEM COMPONENTS**

**FIND OUT MORE**



# 100% BIM

## WE SHARE OUR EXPERTISE

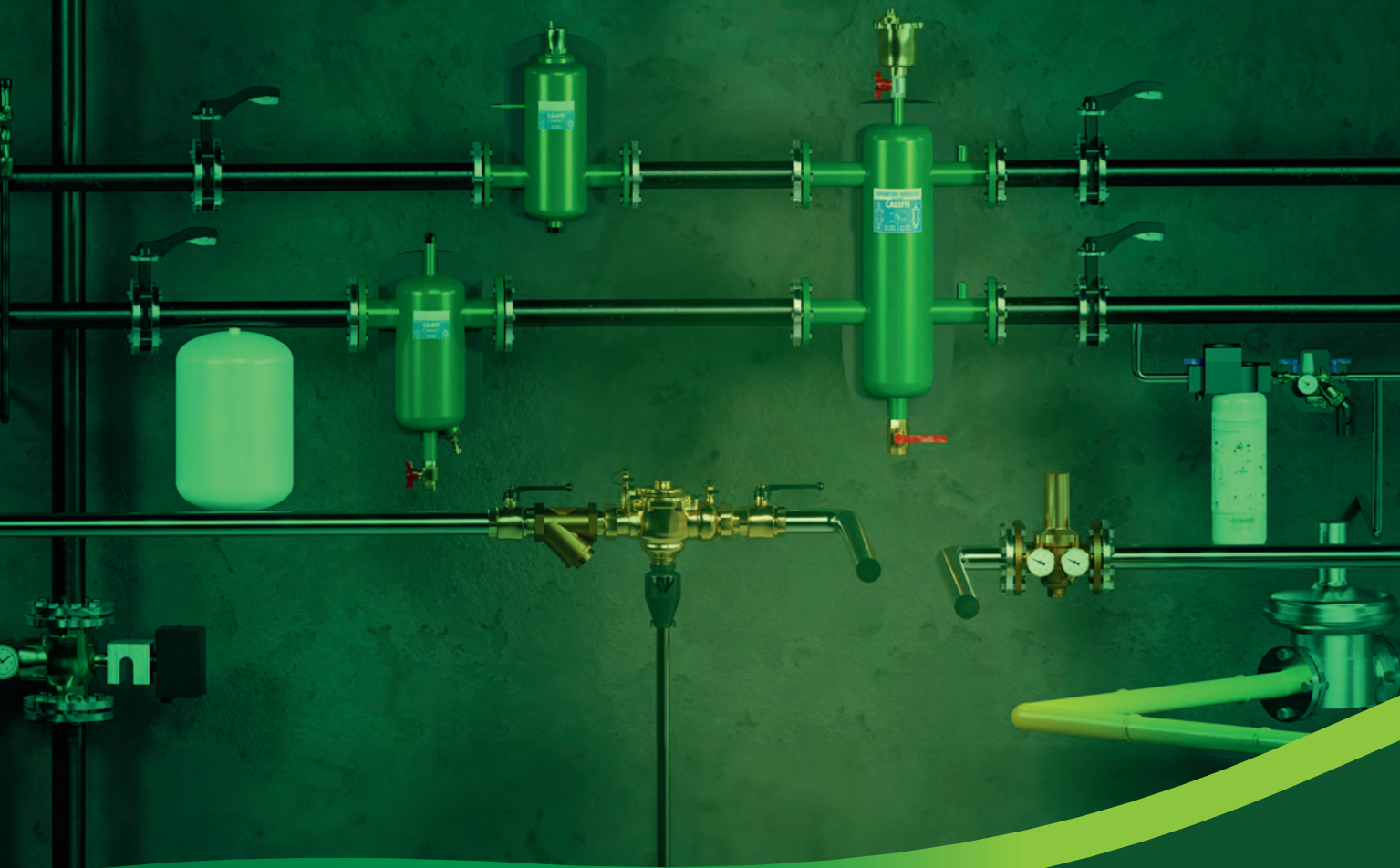

 **+6000**  
professionals  
registered

 **+10 years**  
expertise

 **+4000**  
codes

Explore [bim.caleffi.com](http://bim.caleffi.com), the portal for MEP design professionals. Download virtual models of our products with constantly updated essential data and parameters. Find families (RFA), projects (RVT), and templates for the MEP sector, as well as models in IFC and BOL formats. Join over 6000 professionals who have already chosen our smart design solutions.





# PRODUCTION PLANTS

MADE IN  
ITALY



Caleffi Hydronic Solutions has been redesigning comfort with its HVAC and plumbing solutions for over 60 years.

More than **1000 people** are employed among the Headquarters, the production plants (all set up in Italy) and the foreign branches. Over 90 countries are reached by the brand and new investments are still to come in the near future.

- 1 Caleffi S.p.A.  
Headquarters - Plant 1  
Fontaneto d'Agogna - ITALY
- 2 Caleffi S.p.A.  
Plant 2  
Fontaneto d'Agogna - ITALY
- 3 Caleffi S.p.A.  
Plant 3  
Gattico-Veruno - ITALY
- 4 PRESSCO S.p.A.  
Brass moulding and machining  
Invorio - ITALY

## WHERE WE ARE WORLDWIDE

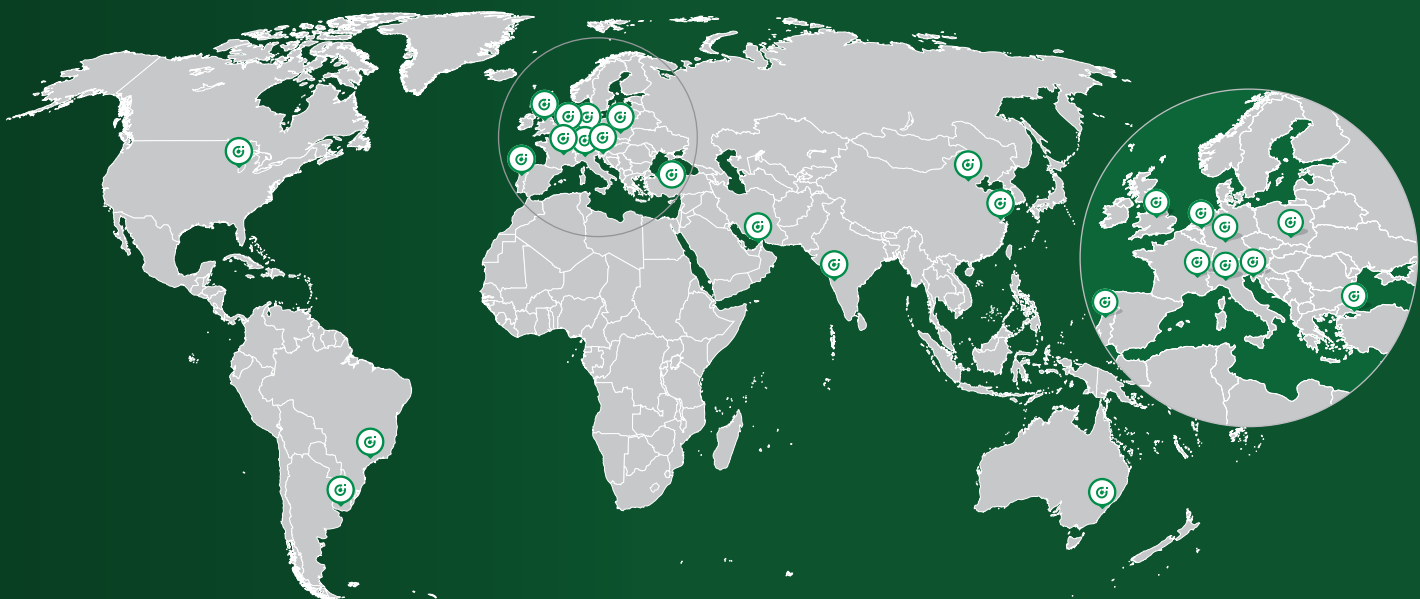

# APPROVAL & CERTIFICATIONS

**bsi.**  
**Certificate of Registration**  
**QUALITY MANAGEMENT SYSTEM - ISO 9001:2015**

This is to certify that: **CALEFFI S.p.A.**  
 S.R. 229 N. 25  
 Fontaneto d'Agogna (NO)  
 28010  
 Italy

Holds Certificate No: **FM 21654**  
 and operates a Quality Management System which complies with the requirements of ISO 9001:2015 for the following scope:

Progettazione, fabbricazione e commercializzazione di componenti, per applicazioni civili e industriali, relativi a impianti di riscaldamento/raffrescamento, agro-serranti, solar, geotermici, idrosonda, trattamento acqua, gas, sistemi di ventilazione e trattamento aria.

For and on behalf of BSI: *Javier Castell*, Branch Manager Italy & Spain

Original Registration Date: 1992-09-28 Effective Date: 2022-01-11  
 Latest Renewal Date: 2022-02-08 Expiry Date: 2024-09-07

ACCREDIA

making excellence a habit.

Certificate No: **FM 21654**

Location: **CALEFFI S.p.A.**  
 S.R. 229 N. 25  
 Fontaneto d'Agogna (NO)  
 28010  
 Italy

Registered Activities:

Progettazione, fabbricazione e commercializzazione di componenti, per applicazioni civili e industriali, relativi a impianti di riscaldamento/raffrescamento, agro-serranti, solar, geotermici, trattamento acqua, gas, sistemi di ventilazione e trattamento aria.

Fabbricazione di componenti, per applicazioni civili e industriali, relativi a impianti di riscaldamento/raffrescamento, agro-serranti, solar, geotermici, idrosonda, trattamento acqua, gas, sistemi di ventilazione e trattamento aria.

Original Registration Date: 1992-09-28 Effective Date: 2022-01-11  
 Latest Renewal Date: 2022-02-08 Expiry Date: 2024-09-07

Page: 2 of 2

CE CE 2011 E 13

INCAL

DIN DEPT DVGW DVGW HY

SWISS SWISS 3212

NF ACS

kiwa

BELGAQUA

UK WRAS UK CA NSF NSF NSF

SWEDEN CERTIFIED BLE

VA 202 DTI

SABS APPROVED SANS 198

W Lead Free

**ICIM**  
**CERTIFICATO N. 0812A/3**  
**CERTIFICATE No. 0812A/3**

CALEFFI S.p.A.

Sede e Unità Operativa  
 Strada Regionale 229, 25 - 28010 Fontaneto d'Agogna (NO) - Italia  
 Progettazione e fabbricazione di componenti strutturali: espansione  
 idrosonde meccaniche (single e multi-ends) e assemblaggio  
 Unità Operativa  
 Via Maggiate, 15 - 28010 Gallio (NO) - Italia  
 Fabbricazione di componenti idrotermici: idrosonde meccaniche  
 (transfer, ultrasonic plastic) e iniezione e assemblaggio  
 e lavorazione di componenti in alluminio (per iniezione)

**UNI EN ISO 14001:2015**  
 Sistema di Gestione Ambientale - Environmental Management System  
 UNI EN ISO 14001:2015 per l'azienda CALEFFI S.p.A.

EA: 18 - 14

Progettazione e fabbricazione di componenti idrotermici, sia per applicazioni in campo civile che industriale, relativi a impianti di riscaldamento/raffrescamento, agro-serranti, solar, geotermici, idrosonda, trattamento acqua, gas, sistemi di ventilazione e trattamento aria.

Design and manufacture of hydrothermal components for civil and industrial applications, by mechanical processes (transference and multi-ends), plastic injection molding and assembly.

Registration Number: IT-83000

ICIM S.p.A.

**IO Net**  
 THE INTERNATIONAL CERTIFICATION NETWORK

**CERTIFICATE**  
 CIG/ICIM SPA has issued an IO Net recognized certificate that the organization:

**CALEFFI S.p.A.**  
 Head Office and Operative Unit  
 Strada Regionale 229, 25 - I-28010 Fontaneto d'Agogna (NO)  
 Operative Unit  
 Via Maggiate, 15 - I-28013 Gallio (NO)

has implemented and maintains a  
**Environmental Management System**  
 for the following scope:

Design and manufacture of hydrothermal components for civil and industrial applications, by mechanical processes (transference and multi-ends), plastic injection molding and assembly.

which fulfills the requirements of the following standard:

**ISO 14001:2015**  
 Issued on: 2021-08-05  
 First issued for: 2022-08-05  
 Expires on: 2024-08-04

Registration Number: IT-83000

ICIM S.p.A. President of IO NET

COMUNITÀ EUROPEA

**AEO**

Certificato AEO IT AEO/ 12 0576

1. Titolare del Certificato AEO  
 CALEFFI S.p.A.  
 Codice Fiscale: 01414890967

2. Autorità che rilascia il Certificato  
 Agenzia delle Dogane  
 Direzione Territoriale Dogane di Gallio in rapporto con  
 gli scambi Lufteo per i regimi doganali e fiscali

Operatore economico autorizzato  
 Semplificazioni doganali / Sicurezza (AEO/)

Data di validità del certificato: 29/06/2012

*Javier Castell*



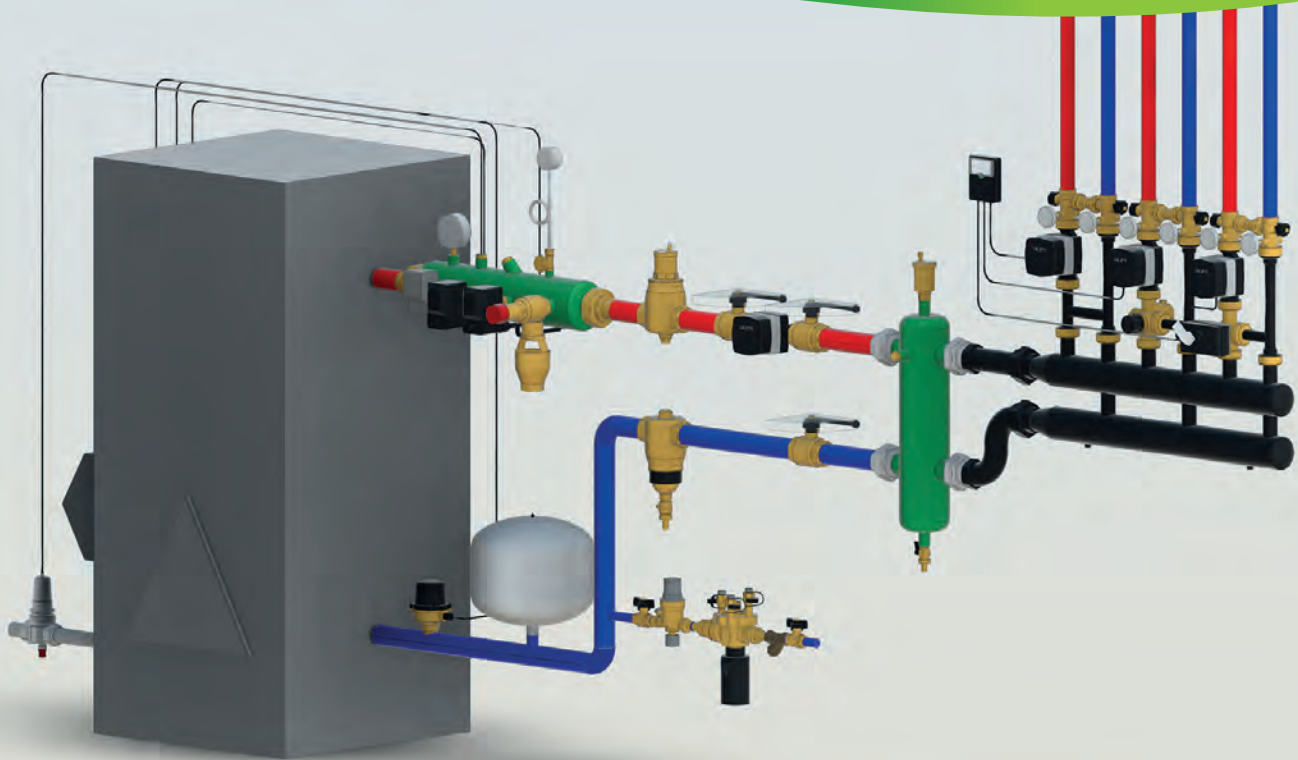

*Diagrams made with BIM families: [bim.caleffi.com](http://bim.caleffi.com)*

- Safety relief valves**
- Temperature and pressure relief valves**
- Differential by-pass valve**
- BALLSTOP - anti-thermosiphon check valve**
- Air separators**
- Instrument holder**
- Automatic filling units**
- Flow switches**
- Automatic shut-off cocks**
- Accessories for boilers**
- Thermostats**
- Pressure gauges and temperature gauges**
- Hydraulic separators**
- Hydraulic separators-manifold SEPCOLL**
- Compact manifolds**
- Manifolds for central heating system**
- Distribution units**
- Temperature regulators**
- Strainers**

**SAFETY RELIEF VALVES**



**527 EST**

tech. broch. 01053

Safety relief valve.  
Female connections.  
Discharge overpressure 10 %.  
Closing differential 20 %.  
PN 10.  
Temperature range: 5–110 °C.



Code

527422 EST	1/2" x 3/4"	2,25 bar	1	25
527425 EST	1/2" x 3/4"	2,5 bar	1	25
527427 EST	1/2" x 3/4"	2,7 bar	1	25
527430 EST	1/2" x 3/4"	3 bar	1	25
527435 EST	1/2" x 3/4"	3,5 bar	1	25
527440 EST	1/2" x 3/4"	4 bar	1	25
527445 EST	1/2" x 3/4"	4,5 bar	1	25
527450 EST	1/2" x 3/4"	5 bar	1	25
527454 EST	1/2" x 3/4"	5,4 bar	1	25
527460 EST	1/2" x 3/4"	6 bar	1	25
527522 EST	3/4" x 1"	2,25 bar	1	25
527525 EST	3/4" x 1"	2,5 bar	1	25
527527 EST	3/4" x 1"	2,7 bar	1	25
527530 EST	3/4" x 1"	3 bar	1	25
527535 EST	3/4" x 1"	3,5 bar	1	25
527540 EST	3/4" x 1"	4 bar	1	25
527545 EST	3/4" x 1"	4,5 bar	1	25
527550 EST	3/4" x 1"	5 bar	1	25
527554 EST	3/4" x 1"	5,4 bar	1	25
527560 EST	3/4" x 1"	6 bar	1	25
527622 EST	1" x 1 1/4"	2,25 bar	1	10
527625 EST	1" x 1 1/4"	2,5 bar	1	10
527627 EST	1" x 1 1/4"	2,7 bar	1	10
527630 EST	1" x 1 1/4"	3 bar	1	10
527635 EST	1" x 1 1/4"	3,5 bar	1	10
527640 EST	1" x 1 1/4"	4 bar	1	10
527645 EST	1" x 1 1/4"	4,5 bar	1	10
527650 EST	1" x 1 1/4"	5 bar	1	10
527654 EST	1" x 1 1/4"	5,4 bar	1	10
527660 EST	1" x 1 1/4"	6 bar	1	10
527722 EST	1 1/4" x 1 1/2"	2,25 bar	1	10
527725 EST	1 1/4" x 1 1/2"	2,5 bar	1	10
527727 EST	1 1/4" x 1 1/2"	2,7 bar	1	10
527730 EST	1 1/4" x 1 1/2"	3 bar	1	10
527735 EST	1 1/4" x 1 1/2"	3,5 bar	1	10
527740 EST	1 1/4" x 1 1/2"	4 bar	1	10
527745 EST	1 1/4" x 1 1/2"	4,5 bar	1	10
527750 EST	1 1/4" x 1 1/2"	5 bar	1	10
527754 EST	1 1/4" x 1 1/2"	5,4 bar	1	10
527760 EST	1 1/4" x 1 1/2"	6 bar	1	10



**5520**

tech. broch. 01053

Pre-formed "special" tundish.



Code

552080	1 1/2" F	1	-
--------	----------	---	---



**527 EST  
Special settings**

tech. broch. 01053

Safety relief valve.  
Female connections.  
Discharge overpressure 10 %.  
Closing differential 20 %.  
PN 10.  
Temperature range: 5–110 °C.



Code

527410 EST	1/2" x 3/4"	1 bar	1	25
527415 EST	1/2" x 3/4"	1,5 bar	1	25
527420 EST	1/2" x 3/4"	2 bar	1	25
527470 EST	1/2" x 3/4"	7 bar	1	25
527480 EST	1/2" x 3/4"	8 bar	1	25
527510 EST	3/4" x 1"	1 bar	1	25
527515 EST	3/4" x 1"	1,5 bar	1	25
527520 EST	3/4" x 1"	2 bar	1	25
527570 EST	3/4" x 1"	7 bar	1	25
527580 EST	3/4" x 1"	8 bar	1	25
527610 EST	1" x 1 1/4"	1 bar	1	10
527615 EST	1" x 1 1/4"	1,5 bar	1	10
527620 EST	1" x 1 1/4"	2 bar	1	10
527670 EST	1" x 1 1/4"	7 bar	1	10
527680 EST	1" x 1 1/4"	8 bar	1	10
527710 EST	1 1/4" x 1 1/2"	1 bar	1	10
527715 EST	1 1/4" x 1 1/2"	1,5 bar	1	10
527720 EST	1 1/4" x 1 1/2"	2 bar	1	10
527770 EST	1 1/4" x 1 1/2"	7 bar	1	10
527780 EST	1 1/4" x 1 1/2"	8 bar	1	10



**5521**

Elbow tundish.

tech. broch. 01053

Code

552140	1/2" M x 3/4"	1	-
552150	3/4" M x 3/4"	1	-
552160	1" M x 1 1/4" F	1	-
552170	1 1/4" M x 1 1/4" F	1	-



**5520**

Straight tundish.

tech. broch. 01053

Code

552050	3/4" F x 3/4" F	1	25
552070	1 1/4" F x 1 1/4" F	1	-

**SAFETY RELIEF VALVES**



**311**

tech. broch. 01253

Safety relief valve.  
Female connections.  
Discharge overpressure 20 %.  
Closing differential 20 %.  
PN 10.  
Temperature range: 5–110 °C.



Code					
311415	1/2"	1,5 bar		1	50
311425	1/2"	2,5 bar		1	50
311430	1/2"	3 bar		1	50
311435	1/2"	3,5 bar		1	50
311440	1/2"	4 bar		1	50
311450	1/2"	5 bar		1	50
311460	1/2"	6 bar		1	50
311470	1/2"	7 bar		1	50
311480	1/2"	8 bar		1	50
311520	3/4"	2 bar		1	50
311525	3/4"	2,5 bar		1	50
311530	3/4"	3 bar		1	50
311535	3/4"	3,5 bar		1	50
311540	3/4"	4 bar		1	50
311550	3/4"	5 bar		1	50
311555	3/4"	5,5 bar		1	50
311560	3/4"	6 bar		1	50
311570	3/4"	7 bar		1	50
311580	3/4"	8 bar		1	50
311590	3/4"	9 bar		1	50



**312**

tech. broch. 01253

Safety relief valve.  
Male - female connections.  
Discharge overpressure 20 %.  
Closing differential 20 %.  
PN 10.  
Temperature range: 5–110 °C.



Code					
312428	1/2"	1,8 bar		1	50
312425	1/2"	2,5 bar		1	50
312430	1/2"	3 bar		1	50
312435	1/2"	3,5 bar		1	50
312440	1/2"	4 bar		1	50
312450	1/2"	5 bar		1	50
312460	1/2"	6 bar		1	50
312470	1/2"	7 bar		1	50
312480	1/2"	8 bar		1	50



**313**

tech. broch. 01253

Safety relief valve.  
Female connections.  
Discharge overpressure 20 %.  
Closing differential 20 %.  
PN 10.  
Temperature range: 5–110 °C.  
Max. pressure gauge temperature: 90 °C.



Code					
313425	1/2"	2,5 bar		1	50
313430	1/2"	3 bar		1	50
313432 *	1/2"	3 bar		1	50
313460	1/2"	6 bar		1	50
313470	1/2"	7 bar		1	50
313480	1/2"	8 bar		1	50
313525	3/4"	2,5 bar		1	50
313530	3/4"	3 bar		1	50
313532 *	3/4"	3 bar		1	50
313560	3/4"	6 bar		1	50
313570	3/4"	7 bar		1	50
313580	3/4"	8 bar		1	50

\* with pressure gauge connection



**314**

tech. broch. 01253

Safety relief valve.  
Male - female connections.  
Discharge overpressure 20 %.  
Closing differential 20 %.  
PN 10.  
Temperature range: 5–110 °C.  
Max. pressure gauge temperature: 90 °C.



Code					
314425	1/2"	2,5 bar		1	50
314430	1/2"	3 bar		1	50
314460	1/2"	6 bar		1	50
314470	1/2"	7 bar		1	50
314480	1/2"	8 bar		1	50

**SAFETY RELIEF VALVES**



**513**

tech. broch. 01253

Safety relief valve.  
Female connections.  
Discharge overpressure 20 %.  
Closing differential 20 %.  
PN 10.  
Temperature range: 5–110 °C.



Code

513415	1/2"	1,5 bar	1	50
513420	1/2"	2 bar	1	50
513425	1/2"	2,5 bar	1	50
513430	1/2"	3 bar	1	50
513435	1/2"	3,5 bar	1	50
513460	1/2"	6 bar	1	50
513470	1/2"	7 bar	1	50
513480	1/2"	8 bar	1	50



**514**

tech. broch. 01253

Safety relief valve.  
Male - female connections.  
Discharge overpressure 20 %.  
Closing differential 20 %.  
PN 10.  
Temperature range: 5–110 °C.



Code

514420	1/2"	2 bar	1	50
514425	1/2"	2,5 bar	1	50
514430	1/2"	3 bar	1	50
514435	1/2"	3,5 bar	1	50
514440	1/2"	4 bar	1	50
514450	1/2"	5 bar	1	50
514460	1/2"	6 bar	1	50
514470	1/2"	7 bar	1	50
514480	1/2"	8 bar	1	50



**513**

tech. broch. 01253

Safety relief valve.  
Female connections.  
Discharge overpressure 20 %.  
Closing differential 20 %.  
PN 10.  
Temperature range: 5–110 °C.



Code

513615	1" x 1 1/4"	1,5 bar	1	25
513620	1" x 1 1/4"	2 bar	1	25
513625	1" x 1 1/4"	2,5 bar	1	25
513630	1" x 1 1/4"	3 bar	1	25
513635	1" x 1 1/4"	3,5 bar	1	25
513640	1" x 1 1/4"	4 bar	1	25
513655	1" x 1 1/4"	5,5 bar	1	25
513660	1" x 1 1/4"	6 bar	1	25
513670	1" x 1 1/4"	7 bar	1	25
513680	1" x 1 1/4"	8 bar	1	25
513725	1 1/4" x 1 1/2"	2,5 bar	1	10
513730	1 1/4" x 1 1/2"	3 bar	1	10
513735	1 1/4" x 1 1/2"	3,5 bar	1	10
513760	1 1/4" x 1 1/2"	6 bar	1	10
513770	1 1/4" x 1 1/2"	7 bar	1	10
513780	1 1/4" x 1 1/2"	8 bar	1	10

**SAFETY RELIEF VALVES WITH NF CERTIFICATION**



**311**

tech. broch. 01253

Safety relief valve.  
Female connections.  
Discharge overpressure 20 %.  
Closing differential 15 %.  
Power rating: 110 kW.  
Temperature range: 5–110 °C.  
Certified to NF P 52-001 - Class 2.



Code  
**311431** 1/2" 3 bar

1 50



**5121**

Safety relief valve.  
Male - female connections.  
Discharge overpressure 20 %.  
Closing differential 15 %.  
Power rating: 110 kW.  
Temperature range: 5–110 °C.  
Certified to NF P 52-001 - Class 2.



Code  
**512131** 1/2" 3 bar

50 -



**313**

tech. broch. 01253

Safety relief valve.  
Female connections.  
With pressure gauge connection.  
Discharge overpressure 20 %.  
Closing differential 15 %.  
Power rating: 110 kW.  
Temperature range: 5–110 °C.  
Certified to NF P 52-001 - Class 2.



Code  
**313433** 1/2" 3 bar

50 -

**SAFETY RELIEF VALVES WITH TÜV CERTIFICATION**



**5320**

Safety relief valve.  
Female connections.  
Discharge overpressure 20 %.  
Closing differential 20 %.  
Power rating: 50 kW.  
Max. percentage of glycol: 50 %.  
Temperature range: 5–120 °C.



Code	Size	Pressure	Green Box	Yellow Box
532042	1/2" x 3/4"	2,5 bar	1	50
532043	1/2" x 3/4"	3 bar	1	50



**530**

Safety relief valve. Female connections.  
Discharge overpressure 20 %.  
Closing differential 20 %.  
Max. percentage of glycol: 50 %.  
Temperature range: 5–120 °C.



Code	Size	Pressure	Green Box	Yellow Box
530525	3/4" x 1"	2,5 bar	1	25
530530	3/4" x 1"	3 bar	1	25



**5321**

Safety relief valve.  
Female connections. With pressure gauge.  
Discharge overpressure 20 %.  
Closing differential 20 %.  
Power rating: 50 kW.  
Max. percentage of glycol: 50 %.  
Temperature range: 5–120 °C.  
Max. pressure gauge temperature: 90 °C.



Code	Size	Pressure	Green Box	Yellow Box
532142	1/2" x 3/4"	2,5 bar	1	50
532143	1/2" x 3/4"	3 bar	1	50



**530**

Safety relief valve. Female connections.  
Discharge overpressure 20 %.  
Closing differential 20 %.  
Max. percentage of glycol: 50 %.  
Temperature range: 5–120 °C.  
**Settings 4 - 5 - 6 - 7 - 8 - 9 bar without TÜV certification.**



Code	Size	Pressure	Green Box	Yellow Box
530625	1" x 1 1/4"	2,5 bar	1	25
530630	1" x 1 1/4"	3 bar	1	25
530640	1" x 1 1/4"	4 bar	1	25
530650	1" x 1 1/4"	5 bar	1	25
530660	1" x 1 1/4"	6 bar	1	25
530670	1" x 1 1/4"	7 bar	1	25
530680	1" x 1 1/4"	8 bar	1	25
530690	1" x 1 1/4"	9 bar	1	25
530725	1 1/4" x 1 1/2"	2,5 bar	1	10
530730	1 1/4" x 1 1/2"	3 bar	1	10
530740	1 1/4" x 1 1/2"	4 bar	1	10
530750	1 1/4" x 1 1/2"	5 bar	1	10
530760	1 1/4" x 1 1/2"	6 bar	1	10
530770	1 1/4" x 1 1/2"	7 bar	1	10
530780	1 1/4" x 1 1/2"	8 bar	1	10
530790	1 1/4" x 1 1/2"	9 bar	1	10



**5322**

Safety relief valve. Female connections.  
With pressure gauge connection.  
Discharge overpressure 20 %.  
Closing differential 20 %.  
Power rating: 50 kW.  
Max. percentage of glycol: 50 %.  
Temperature range: 5–120 °C.



Code	Size	Pressure	Green Box	Yellow Box
532242	1/2" x 3/4"	2,5 bar	1	50
532243	1/2" x 3/4"	3 bar	1	50



**5327**

Safety relief valve.  
Male - female connections.  
Discharge overpressure 20 %.  
Closing differential 20 %.  
Power rating: 50 kW.  
Max. percentage of glycol: 50 %.  
Temperature range: 5–120 °C.



Code	Size	Pressure	Green Box	Yellow Box
532742	1/2" x 3/4"	2,5 bar	48	–
532743	1/2" x 3/4"	3 bar	48	–



## SAFETY RELIEF VALVES FOR DOMESTIC WATER SYSTEMS



### 531

Safety relief valve  
for domestic water systems.  
Female connections.  
Discharge overpressure 20 %.  
Closing differential 20 %.  
Medium: water.  
Temperature range: 5–95 °C.



Code

531440	1/2" x 3/4"	4 bar	1	50
531460	1/2" x 3/4"	6 bar	1	50
531480	1/2" x 3/4"	8 bar	1	50
531410	1/2" x 3/4"	10 bar	1	50
531540	3/4" x 1"	4 bar	1	25
531560	3/4" x 1"	6 bar	1	25
531580	3/4" x 1"	8 bar	1	25
531510	3/4" x 1"	10 bar	1	25



### 531

Safety relief valve  
for domestic water systems.  
Female connections.  
Discharge overpressure 20 %.  
Closing differential 20 %.  
Medium: water.  
Temperature range: 5–95 °C.  
Settings: 4 - 6 - 8 - 10 bar.



Code

531640	1" x 1 1/4"	4 bar	1	25
531660	1" x 1 1/4"	6 bar	1	25
531680	1" x 1 1/4"	8 bar	1	25
531610	1" x 1 1/4"	10 bar	1	25
531740	1 1/4" x 1 1/2"	4 bar	1	10
531760	1 1/4" x 1 1/2"	6 bar	1	10
531780	1 1/4" x 1 1/2"	8 bar	1	10
531710	1 1/4" x 1 1/2"	10 bar	1	10

## TEMPERATURE AND PRESSURE RELIEF VALVES

### 309

tech. broch. 01130



Temperature and pressure relief valve.  
CR dezincification resistant alloy body.  
For domestic water system,  
to protect the hot water storage.  
Set temperature: 90 °C.  
Discharge rating: 1/2" - 3/4" x Ø 15: 10 kW.  
3/4" x Ø 22: 25 kW.  
Settings certified to EN 1490: 4 - 7 - 10 bar.



Code

Code			Probe length (mm)		
309430	1/2" M x Ø 15	3 bar	100	1	20
309440	1/2" M x Ø 15	4 bar	100	1	20
309460	1/2" M x Ø 15	6 bar	100	1	20
309470	1/2" M x Ø 15	7 bar	100	1	20
309400	1/2" M x Ø 15	10 bar	100	1	20
309542	3/4" M x Ø 15	4 bar	100	1	20
309530	3/4" M x Ø 22	3 bar	100	1	20
309560	3/4" M x Ø 22	6 bar	100	1	20
309570	3/4" M x Ø 22	7 bar	100	1	20
309500	3/4" M x Ø 22	10 bar	100	1	20

Code

Code			Probe length (mm)		
309435	1/2" M x Ø 15	3 bar	200	1	20
309445	1/2" M x Ø 15	4 bar	200	1	20
309465	1/2" M x Ø 15	6 bar	200	1	20
309475	1/2" M x Ø 15	7 bar	200	1	20
309405	1/2" M x Ø 15	10 bar	200	1	20
309547	3/4" M x Ø 15	4 bar	200	1	20
309535	3/4" M x Ø 22	3 bar	200	1	20
309565	3/4" M x Ø 22	6 bar	200	1	20
309575	3/4" M x Ø 22	7 bar	200	1	20
309505	3/4" M x Ø 22	10 bar	200	1	20

### 309

Temperature and pressure relief valve.  
CR dezincification resistant alloy body.  
For domestic water system,  
to protect the hot water storage.  
Set temperature: 95 °C.  
Discharge rating: 25 kW.  
Setting: 6 bar.  
For systems with nominal pressure of 400 kPa.



Code

Code			Probe length (mm)		
309563	3/4" M x Ø 22	6 bar	100	1	20

**DIFFERENTIAL BY-PASS VALVES**



**519**

tech. broch. 01007

Differential by-pass valve, adjustable with graduated scale. Max. working pressure: 10 bar. Temperature range: 0–110 °C. Max. percentage of glycol: 30 %.



**Threaded connections**

Code		Setting range m w.g.		
<b>519500</b>	3/4"	1–6	1	50
<b>519504</b>	3/4"	10–40	1	50
<b>519700</b>	1 1/4"	1–6	1	10
<b>519703</b>	1 1/4"	5–25	1	10

**Compression ends**

Code		Setting range m w.g.		
<b>519002</b>	∅ 22	1–6	1	50



**518**

tech. broch. 01007

Differential by-pass valve, adjustable with graduated scale. Max. working pressure: 10 bar. Temperature range: 0–100 °C. Max. percentage of glycol: 30 %.

Code		Setting range m w.g.		
<b>518015</b>	3/4"	1–6	1	25



**518**

tech. broch. 01410

Differential by-pass valve, adjustable with graduated scale. Max. working pressure: 10 bar. Temperature range: 0–100 °C. Max. percentage of glycol: 30 %.

**Threaded connections**

Code		Setting range m w.g.		
<b>518500</b>	3/4"	1–6	1	50

**Compression ends**

Code		Setting range m w.g.		
<b>518002</b>	∅ 22	1–6	1	50

**BALLSTOP - ANTI-THERMOSIPHON**



**327  
BALLSTOP**

tech. broch. 01021

Ball valve with built-in check valve for heating systems. Low head losses. Max. working pressure: 16 bar. Temperature range: 5–110 °C.

Code				
<b>327400</b>	1/2"	butterfly handle	10	–
<b>327500</b>	3/4"	butterfly handle	10	–
<b>327600</b>	1"	lever handle	4	–
<b>327700</b>	1 1/4"	lever handle	4	–
<b>327800</b>	1 1/2"	lever handle	2	–
<b>327900</b>	2"	lever handle	1	–



**510**

tech. broch. 01045

Anti-thermosiphon check valve to prevent natural circulation of water. Removable cap allows straight or angled installations. Max. working pressure: 10 bar. Temperature range: 5–110 °C.

Code				
<b>510500</b>	3/4"		1	20
<b>510600</b>	1"		1	20
<b>510700</b>	1 1/4"		1	20

**AIR SEPARATOR**



**547**

Air separator. Cast iron body. Female connections.

Code				
<b>547060</b>	1"		1	10
<b>547070</b>	1 1/4"		1	10
<b>547080</b>	1 1/2"		1	10
<b>547090</b>	2"		1	10
<b>547200</b>	2 1/2"		1	–
<b>547300</b>	3"		1	–



**547**

Air separator. Steel body. Flanged connections PN 16. To be coupled with flat counterflanges EN 1092-1.

Code				
<b>547400</b>	DN 100		1	–
<b>547500</b>	DN 125		1	–

## INSTRUMENT HOLDER FOR EXPANSION VESSEL

### 336

Instrument holder for heating systems. Equipped with automatic shut-off cock for expansion vessel and male connection for safety valve 531 series. Max. working temperature: 110 °C. Up to 50 kW.





Code			
336600	3/4"	2	10

### 336

Assembled instrument holder for heating systems. Equipped with air vent, safety relief valve, pressure gauge and automatic shut-off cock for expansion vessel. Max. working temperature: 110 °C. Up to 50 kW.



Code			
336630	3/4" 3 bar with automatic shut-off cock	1	5
336631	3/4" 3 bar with ball shut-off cock	1	5

### 305

Instrument holder kit in technopolymer material for heating systems. Equipped with air vent, safety relief valve in technopolymer material, pressure gauge, automatic shut-off cock for expansion vessel and fixing bracket. **With insulation.** Temperature range: 5–90 °C. Up to 50 kW.

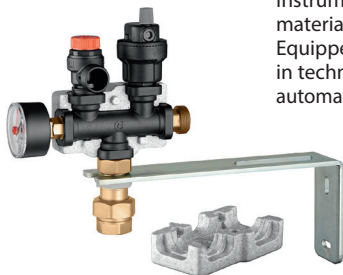



Code			
305503	3/4" 3 bar TÜV	1	10

## INSTRUMENT HOLDER

### 302

Combined air separator with heating system accessories. Equipped with air vent, safety relief valve and pressure gauge. Max. working temperature: 110 °C. Up to 50 kW.



Code			
302630	1" 3 bar	1	10
302631	1" 3 bar with pre-formed insulation	1	10

### 305

Instrument holder in technopolymer material for heating systems. Equipped with air vent, safety relief valve in technopolymer material and pressure gauge. **With insulation.** Temperature range: 5–90 °C. Up to 50 kW.

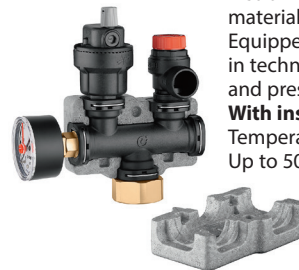



Code			
305663	1" 3 bar TÜV	1	5

### 305

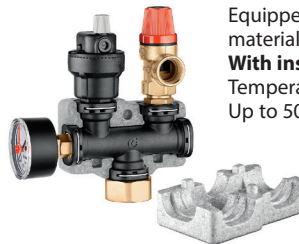
Instrument holder in technopolymer material for heating systems. Equipped with air vent in technopolymer material, safety relief valve and pressure gauge. **With insulation.** Temperature range: 5–90 °C. Up to 50 kW.



Code			
305671	1" 1,8 bar	1	5
305673	1" 3 bar NF	1	5
305674	1" 4 bar without insulation	1	5

**AUTOMATIC FILLING UNITS**



**553**

tech. broch. 01061

Pre-adjustable automatic filling unit, anti-scale, inspectionable, with pressure setting indicator, manual cock, strainer, check valve. Setting pressure range: 0,2–4 bar. Max. inlet pressure: 16 bar. Max. working temperature: 65 °C.

Code

553540	1/2" with pressure gauge connection	1	10
553640	1/2" with pressure gauge	1	10



**553**

tech. broch. 01025

Automatic filling unit, with manual cock, strainer, check valve. Setting pressure range: 0,3–4 bar. Max. inlet pressure: 16 bar. Max. working temperature: 70 °C.

Code

553040	1/2" with pressure gauge connection	1	10
553140	1/2" with pressure gauge	1	10



**553**

Pre-adjustable automatic filling unit, anti-scale, inspectionable, with pressure setting indicator, manual cock, strainer and check valve. **With hose connection.** Setting pressure range: 0,2–4 bar. Max. inlet pressure: 16 bar. Max. working temperature: 65 °C.

Code

553740	1/2" with pressure gauge connection	1	10
553840	1/2" with pressure gauge	1	10

**554**

tech. broch. 01125

Pre-adjustable automatic filling unit for high flow rates, with double shut-off valve, check valve. Self-contained replaceable cartridge. Setting pressure range: 1–6 bar. Max. inlet pressure: 16 bar. Max. working temperature: 60 °C.



Code

554040	1/2" with pressure gauge connection	1	–
554140	1/2" with pressure gauge	1	–
554150	3/4" with pressure gauge	1	–

**BOILER FILLING LOOP**

**3006 ROBOFIL**

Boiler filling loop. CR dezincification resistant alloy body. Equipped with double check valve with shut-off valve, hose connection and shut-off valve.

Max. working pressure: 10 bar.  
Max. working temperature: 95 °C.  
Flexible hose length: 400 mm.



Code

300600		1	10
--------	--	---	----

**AUTOMATIC CHARGING UNITS**

**573001**

tech. broch. 01061

Automatic charging unit with **CAa type** backflow preventer and shut-off valve.

Filling unit setting pressure range: 0,2–4 bar.  
Max. working pressure: 10 bar.  
Max. working temperature: 65 °C.  
Backflow preventer certified to EN 14367 standard.



Code			
<b>573001</b>	1/2"	1	5

**574011**

tech. broch. 01161

Compact automatic charging unit with **BA type** backflow preventer, shut-off valve and strainer.

**With pre-formed insulation.**  
Filling unit setting pressure range: 0,2–4 bar.  
Max. working pressure: 10 bar.  
Max. working temperature: 65 °C.  
Backflow preventer certified to EN 12729 standard.



Code			
<b>574011</b>	1/2"	1	5

**574000**

tech. broch. 01061

Automatic charging unit with **BA type** backflow preventer, Y-strainer and shut-off valve.  
Filling unit setting pressure range: 0,2–4 bar.  
Max. working pressure: 10 bar.

Max. working temperature: 65 °C.  
Backflow preventer certified to EN 12729 standard.



Code			
<b>574000</b>	1/2"	1	5

**574001**

tech. broch. 01125

Automatic charging unit with **BA type** backflow preventer, Y-strainer and shut-off valve.  
Pressure reducing valve setting pressure range: 1–6 bar.

Max. working pressure: 10 bar.  
Max. working temperature: 60 °C.  
Backflow preventer certified to EN 12729 standard.



Code			
<b>574001</b>	3/4"	1	-

**AUTOMATIC COMPACT CHARGING UNIT**

**580011**

tech. broch. 01361

Automatic compact charging unit to EN 1717 standard with **BA type** backflow preventer, shut-off valve, strainer, pressure test ports for controlling the backflow preventer, pressure reducing valve. For horizontal or vertical installations. Brass body.



**With insulation.**

Filling unit setting pressure range: 0,8–4 bar.  
Max. working pressure: 10 bar.  
Max. working temperature: 65 °C.  
Backflow preventer certified to EN 12729 standard.  
Pressure reducing valve certified to EN 1567 standard.  
PATENT.



Code			
<b>580011</b>	1/2"	1	5

**580010**

tech. broch. 01333

Automatic compact charging unit to EN 1717 standard with **BA type** backflow preventer, shut-off valve, strainer, pressure test ports for controlling the backflow preventer, pressure reducing valve. For horizontal or vertical installations. **CR** dezincification resistant alloy body.

**With insulation.**

Filling unit setting pressure range: 0,8–4 bar.  
Max. working pressure: 10 bar.  
Max. working temperature: 65 °C.  
Backflow preventer certified to EN 12729 standard.  
Pressure reducing valve certified to EN 1567 standard.  
PATENT PENDING.



Code			
<b>580010</b>	1/2"	1	5

**FLOW SWITCHES**

**315**

tech. broch. 01184



Flow switch with magnetically operated contacts. 230 V - 0,02 A (an appropriate relais must be used in case of higher power consumption). Max. working pressure: 6 bar. Temperature range: -15–100 °C.



Contact closing with  
**increasing flow rate** at: 156 l/h (1/2")  
 456 l/h (3/4")  
 Contact opening with  
**decreasing flow rate** at: 108 l/h (1/2")  
 348 l/h (3/4")

Code			
315400	1/2"	1	50
315500	3/4"	1	25

**626**

tech. broch. 01052



Flow switch. Suitable for 1" to 8" pipes. 250 V (AC) - 15 (5) A. Max. working pressure: 10 bar. Temperature range: -30–120 °C. Protection class: IP 54.



Code			
626600	1"	1	5
626009	set of blades	1	-

**SHUT-OFF COCK FOR EXPANSION VESSELS**

**558**



Automatic shut-off cock, for expansion vessels. **For domestic water circuit.** Max. working pressure: 10 bar. Max. working temperature: 110 °C.

Code			
558500	3/4"	1	50

**558**



Automatic shut-off cock, for expansion vessel, with drain cock. **For domestic water circuit.** Max. working pressure: 6 bar. Max. working temperature: 85 °C.

Code			
558510	3/4"	1	50

**5580**



Ball shut-off valve, for expansion vessels, with drain cock. **For domestic water circuit.** Max. working pressure: 6 bar. Max. working temperature: 85 °C.

Code			
558050	3/4"	1	20
558060	1"	1	20
558070	1 1/4"	1	20

**5580**



Ball shut-off valve, for expansion vessels, with drain cock. **For solar thermal systems.** Max. working pressure: 6 bar. **Max. working temperature: 120 °C.** **Max. percentage of glycol: 50 %.**

Code			
558052	3/4"	1	20
558062	1"	1	20

Application diagram of shut-off valve 5580 series

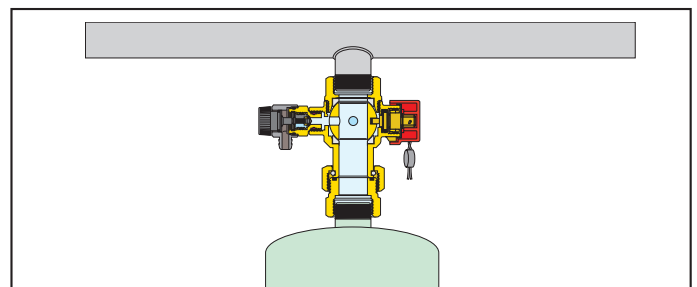

ACCESSORIES FOR BOILERS



690

Three way tap for INAIL master pressure gauge.  
Max. working pressure: 15 bar.  
Temperature range: 5-90 °C.

Code			
690200	1/4"	5	-
690300	3/8"	5	-
690400	1/2"	5	-



538

Drain cock with hose connection and cap.  
Max. working pressure: 10 bar.  
Max. working temperature: 110 °C.



Code			
538201	1/4" M	1	-
538400	1/2" M	1	100



691

Water hammer reducing loop.  
In chrome plated copper.

Code			
691200	1/4"	5	-
691300	3/8"	5	-
691400	1/2"	5	-



538

Drain cock with hose connection and cap.  
**Complete with manual lever.**  
Max. working pressure: 10 bar.  
Max. working temperature: 110 °C.

Code			
538405	1/2" M	1	100



694

INAIL test pocket,  
1/2" connection.

Code	Pocket length		
694045	45 mm	1	-
694100	100 mm	1	-



692

Thermometer in sleeve.  
1/2" pocket connection.

Code	Pocket length	°C		
692000	45 mm	0-120	1	-



693

Bulb thermometer.

Code	°C		
693000	0-120	1	-

THERMOSTATS

**621**  
Adjustable contact thermostat.  
Temperature range: 20–90 °C.  
Protection class: IP 20.



CE  
INAIL  
EKO3  
DIN  
Gepruft

Code	1	10
621000	1	10

**622**  
Adjustable immersion thermostat.  
Temperature range: 0–90 °C.  
With 1/2" connection pocket.  
Protection class: IP 40.



CE  
INAIL  
EKO3  
DIN  
Gepruft

Code	1	10
622000	1	10

**622**  
Stainless steel pocket  
for domestic application exempt from INAIL  
certification requirements.  
For thermostat code 622000.  
Max. working pressure: 15 bar.  
Temperature range: 0–100 °C.



CE  
INAIL  
EKO3  
DIN  
Gepruft

Code	1	10
622010 1/2" M	1	-

**623**  
Double immersion thermostat:  
- safety thermostat with manual reset,  
setting 100 °C (+0 °C -6 °C),  
setting 110 °C (+0 °C -6 °C)  
- adjustment thermostat,  
temperature range: 0–90 °C,  
temperature range: 0–100 °C.  
With 1/2" connection pocket.  
Protection class: IP 40.



CE  
INAIL  
EKO3  
DIN  
Gepruft

Code	Safety setting	Adjustment range	1	10
623000	100 °C	0–90 °C	1	5
623100	110 °C	0–100 °C	1	5

**624**  
Immersion safety thermostat,  
with manual reset,  
- setting 100 °C (+0 °C -6 °C),  
- setting 110 °C (+0 °C -6 °C).  
With 1/2" connection pocket.  
Protection class: IP 40.



CE  
INAIL  
EKO3  
DIN  
Gepruft

Code	Safety setting	1	10
624000	100 °C	1	10
624100	110 °C	1	10

Spare pocket for 622, 623 and 624 series.



Code	Use	1	10
622401	622 - 624 series	1	-
623002	623 series	1	-

PRESSURE SWITCHES

**625**  
Safety pressure switch, with manual reset.  
250 V - 16 (10) A.  
Max. working pressure: 5 bar.  
Ambient temperature range: 0–50 °C.  
Medium temperature range: 20–110 °C.  
1/4" female connection.  
Protection class: IP 44.



CE

Code	Setting range	1	50
625000	2–4,5 bar	1	50

**625**  
Minimum pressure safety switch,  
with manual reset.  
250 V - 16 (10) A.  
Max. working pressure: 5 bar.  
Ambient temperature range: 0–50 °C.  
Medium temperature range: 20–110 °C.  
1/4" female connection.  
Protection class: IP 44.



CE

Code	Setting range	1	10
625100	0,5–1,7 bar	1	10

**625**  
Pressure switch for boosting sets and domestic  
water applications.  
Up to 500 V three-pole - 16 (10) A.  
Ambient temperature range: 0–55 °C.  
Medium temperature range: 0–55 °C.  
1/4" female connection.  
Protection class: IP 44.



CE

Code	Setting range	Max. pressure	1	10
625005	1– 5 bar	5 bar	1	10
625010	3–12 bar	12 bar	1	10

**613**  
Float switch,  
250 V - 10 A.  
Heavy duty approved.



EKO3

Code	Cable length	1	5
613030	3 m	1	5
613050	5 m	1	5



TEMPERATURE AND PRESSURE GAUGES



557

Pressure gauge.  
Accuracy class: UNI 2,5.  
Temperature range: -20-90 °C.

Code	bar	Position	Ø		
557104	0-4	1/4" central back conn.	50	1	-
557204	0-4	1/4" "off-centred" back conn.	50	1	-
557304	0-4	1/4" bottom conn.	50	1	-
557106	0-6	1/4" central back conn.	50	1	-
557306	0-6	1/4" bottom conn.	50	1	-
557310	0-10	1/4" bottom conn.	50	1	-
557410	0-10	1/4" central back conn.	63	1	-
557425	0-25	1/4" central back conn.	63	1	-
557704	0-4	3/8" bottom conn.	80	1	-
557706	0-6	3/8" bottom conn.	80	1	-
557710	0-10	3/8" bottom conn.	80	1	-



688

Temperature gauge.  
1/2" central back connection.  
With pocket.  
Ø 80 mm.  
Accuracy class: UNI 2.

Code	Pocket length	°C		
688000	45 mm	0-120	1	10
688010	100 mm	0-120	1	5
688011	without pocket	0-120	1	5



688

Temperature gauge.  
1/2" bottom connection.  
With pocket.  
Ø 80 mm.  
Accuracy class: UNI 2.

Code	Pocket length	°C		
688100	45 mm	0-120	1	10



503

Temperature/pressure gauge.  
1/2" central back connection.  
With shut-off pocket.  
Ø 80 mm.  
Accuracy class:  
- temperature gauge UNI 2;  
- pressure gauge UNI 2,5.

Code	bar	°C		
503040	0-4	0-120	1	10
503060	0-6	0-120	1	10



687

Temperature gauge for cooling systems.  
1/2" central back connection.  
With pocket.  
Ø 80 mm.  
Accuracy class: UNI 2.

Code	Pocket length	°C		
687000	45 mm	-30-50	1	-
687010	100 mm	-30-50	1	-



503

Temperature/pressure gauge.  
1/2" bottom connection.  
With shut-off pocket.  
Ø 80 mm.  
Accuracy class:  
- temperature gauge UNI 2;  
- pressure gauge UNI 2,5.

Code	bar	°C		
503140	0-4	0-120	1	20
503160	0-6	0-120	1	20



687

Temperature gauge for cooling.  
1/2" bottom connection.  
With pocket.  
Ø 80 mm.  
Accuracy class: UNI 2.

Code	Pocket length	°C		
687110	100 mm	-30-50	1	10



5560

Pressure gauge  
for expansion vessel pressure test.  
Accuracy class: UNI 2,5.

Code	bar		
556000	0-10	1	-



689

Flow gauge.  
3/8" bottom connection.  
Ø 80 mm.  
Accuracy class: UNI 2,5.  
Temperature range: -20-90 °C.

Code	m w.g.		
689010	0-10	1	20
689016	0-16	1	20
689025	0-25	1	30

For higher pressures see pressure gauges 557 series.



HYDRAULIC SEPARATOR

548

tech. broch. 01404



Hydraulic separator.  
Epoxy resin coated steel body.  
**With pre-formed insulation.**  
Female union connections.  
Max. working pressure: 10 bar.  
Temperature range: 0–100 °C.  
Complete with:  
air vent with automatic shut-off cock,  
drain cock.

Code		Max. recommended flow rate m <sup>3</sup> /h		
548006	1"	2,5	1	–
548007	1 1/4"	4	1	–
548008	1 1/2"	6	1	–
548009	2"	8,5	1	–

Choice of hydraulic separator 548 series



The hydraulic separator should be sized according to the **maximum flow rate value at the inlet**. The selected design value must be the greatest between the primary circuit and the secondary circuit.

548

tech. broch. 01404



Hydraulic separator.  
Epoxy resin coated steel body.  
**With pre-formed insulation.**  
Flanged connections PN 16.  
To be coupled with flat counterflanges EN 1092-1.  
Max. working pressure: 10 bar.  
Temperature range:  
0–105 °C (DN 50–DN 100),  
0–100 °C (DN 125 - DN 150).  
Temperature probe connection: 1/2" F.  
Complete with:  
automatic air vent, shut-off valve,  
drain valve.

Code		Max. recommended flow rate m <sup>3</sup> /h		
548052	DN 50	9	1	–
548062	DN 65	18	1	–
548082	DN 80	28	1	–
548102	DN 100	56	1	–
548122	DN 125	75	1	–
548152	DN 150	110	1	–

548 series hydraulic separator application diagram

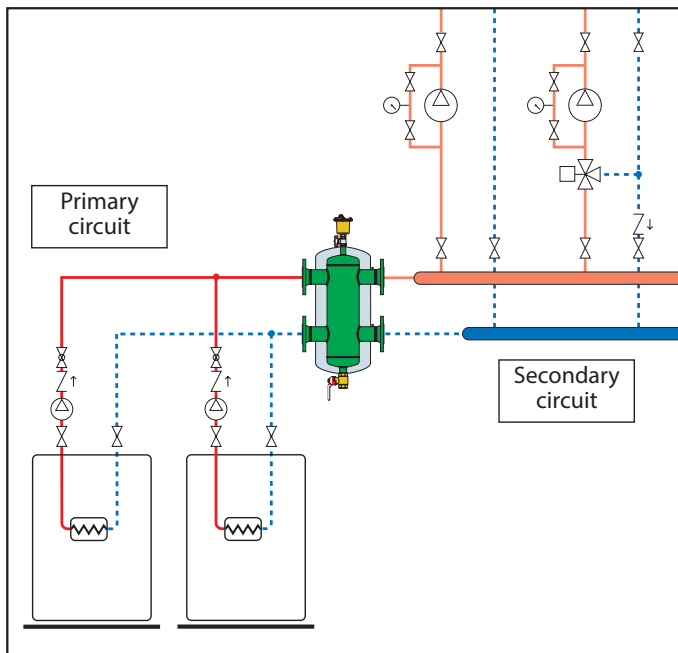



548

tech. broch. 01404



Hydraulic separator.  
Epoxy resin coated steel body.  
Flanged connections PN 10.  
To be coupled with flat counterflanges EN 1092-1.  
Max. working pressure: 10 bar.  
Temperature range: 0–110 °C.  
Temperature probe connection: 1/2" F.  
Complete with:  
automatic air vent, shut-off valve,  
drain valve.

Code		Max. recommended flow rate m <sup>3</sup> /h		
548200	DN 200	180	1	–
548250	DN 250	300	1	–
548300	DN 300	420	1	–

MULTIFUNCTION HYDRAULIC SEPARATOR



5495 SEP4

tech. broch. 01404

Multifunction hydraulic separator. Epoxy resin coated steel body.

**With pre-formed insulation.**

Female union connections.

Max. working pressure: 10 bar.

Temperature range: 0–100 °C.

Complete with:

- hydraulic separator,
- automatic air vent,
- dirt separator,
- magnetic ring,
- drain cock with hose connection.



Function

The multifunction hydraulic separator combines different functional components, each of them to satisfy specific needs of heating and cooling system circuits.

It is supplied complete with hot pre-formed shell insulation to ensure perfect thermal insulation when used with both hot and chilled water.

The device is designed to carry out the following functions:

- **Hydraulic separation**

To keep connected hydraulic circuits totally independent from each other.

- **Deaeration**



Utilises the combined action of several physics principles: the widening of the cross section decreases the flow velocity and the technopolymer mesh creates whirling movements so as to facilitate the release of micro-bubbles. The bubbles, fusing with each other, increase in volume and, rising towards the top of the unit, are released through a float-operated automatic air vent.

- **Dirt separation**

The dirt separator separates and collects any impurities in the circuits as they collide with the surface of the internal element.

- **Removal of magnetic particles**

The special patented magnetic system also attracts ferromagnetic impurities in the water: the ferromagnetic particles are trapped in the collection zone, meaning they are prevented from being recirculated.

Code		Max. recommended flow rate m <sup>3</sup> /h		
549506	1"	2,5	1	-
549507	1 1/4"	4	1	-
549508	1 1/2"	6	1	-
549509	2"	8,5	1	-

Hydraulic separation

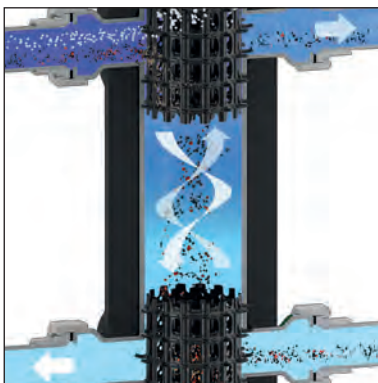

Dirt removal

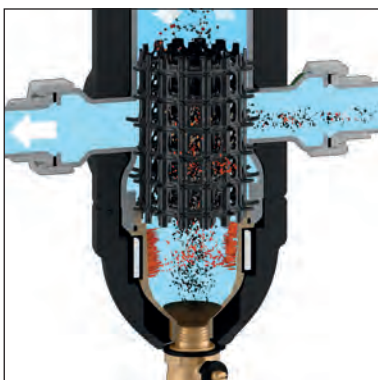

Deaeration



Removal of magnetic particles

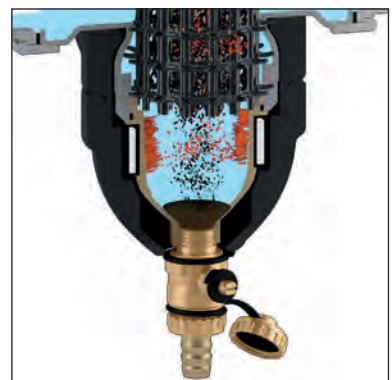

**HYDRAULIC SEPARATOR-MANIFOLD**  
**Outlet centre distance 90 mm**



**559 SEPCOLL 2+1.** tech. broch. 01084  
 Hydraulic separator-manifold for heating and cooling systems. Steel body, PN 6.

**With pre-formed insulation.**  
 1" F main connections.  
 Outlet connections: two 1" M at the top with captive nut and one 1" F at the side.  
 Temperature range: 0–110 °C.  
 Complete with mounting brackets.

Code	Outlet centre distance		
559021	90 mm	1	-



**559 SEPCOLL 2+2.** tech. broch. 01084  
 Hydraulic separator-manifold for heating and cooling systems. Steel body, PN 6.  
**With pre-formed insulation.**

1 1/4" F main connections.  
 1" M outlet connections: two at the top and two at the bottom.  
 Temperature range: 0–110 °C.  
 Complete with mounting brackets.

Code	Outlet centre distance		
559022	90 mm	1	-



**559 SEPCOLL 3+1.** tech. broch. 01084  
 Hydraulic separator-manifold for heating and cooling systems. Steel body, PN 6.

**With pre-formed insulation.**  
 1 1/4" F main connections.  
 1" M outlet connections: three at the top and one at the bottom (can be inverted).  
 Temperature range: 0–110 °C.  
 Complete with mounting brackets.

Code	Outlet centre distance		
559031	90 mm	1	-

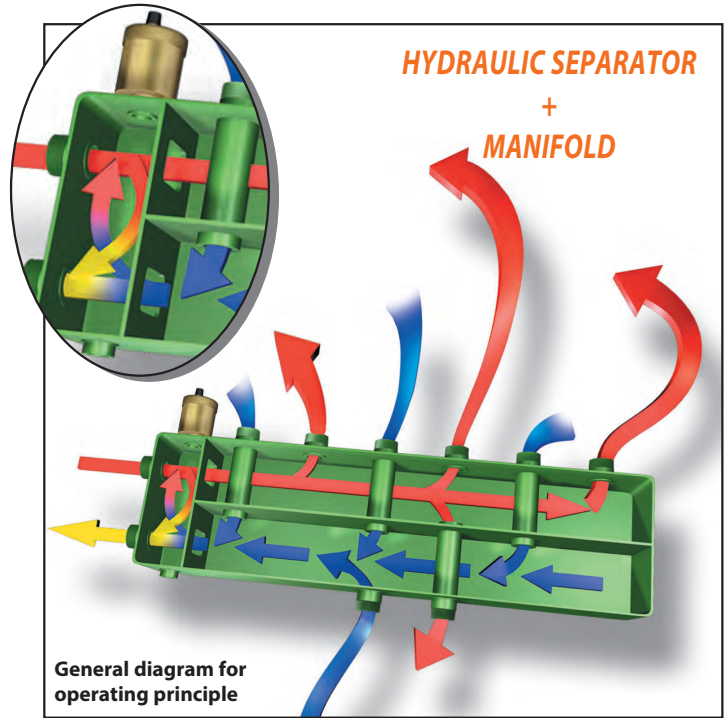

**Hydraulic connections**



559021

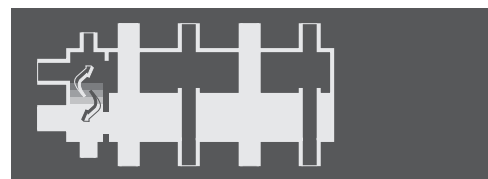

559022



559031

Maximum recommended flow rate at inlets of SEPCOLL separator 559 series		
Outlets	Primary	Secondary (total)
2+1 / 2	2 m <sup>3</sup> /h	5 m <sup>3</sup> /h
2+2	2,5 m <sup>3</sup> /h	6 m <sup>3</sup> /h
3+1	2,5 m <sup>3</sup> /h	6 m <sup>3</sup> /h

## HYDRAULIC SEPARATOR-MANIFOLD

### Outlet centre distance 125 mm



**559** tech. broch. 01084

### SEPCOLL 2.

Hydraulic separator-manifold for heating and cooling systems. Steel body, PN 6.

**With pre-formed insulation.**

1" F main connections.  
Outlet connections: two 1 1/2" at the top with captive nut.  
Temperature range: 0–110 °C.  
Complete with mounting brackets.

Code	Outlet centre distance		
559220	125 mm	1	–



**559** tech. broch. 01084

### SEPCOLL 2+1.

Hydraulic separator-manifold for heating and cooling systems. Steel body, PN 6.

**With pre-formed insulation.**

1" F main connections.  
Outlet connections: two 1 1/2" at the top with captive nut and one 1" F at the side.  
Temperature range: 0–110 °C.  
Complete with mounting brackets.

Code	Outlet centre distance		
559221	125 mm	1	–



**559** tech. broch. 01084

### SEPCOLL 2+2.

Hydraulic separator-manifold for heating and cooling systems. Steel body, PN 6.

**With pre-formed insulation.**

1 1/4" F main connections.  
1 1/2" outlet connections with captive nut: two at the top and two at the bottom.  
Temperature range: 0–110 °C.  
Complete with mounting brackets.

Code	Outlet centre distance		
559222	125 mm	1	–



**559** tech. broch. 01084

### SEPCOLL 3+1.

Hydraulic separator-manifold for heating and cooling systems. Steel body, PN 6.

**With pre-formed insulation.**

1 1/4" F main connections.  
1 1/2" outlet connections with captive nut: three at the top and one at the bottom (can be inverted).  
Temperature range: 0–110 °C.  
Complete with mounting brackets.

Code	Outlet centre distance		
559231	125 mm	1	–

#### Hydraulic connections



559220



559221

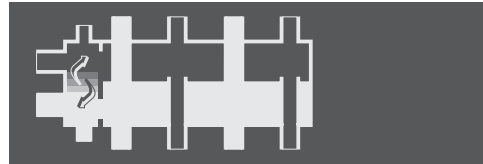

559222

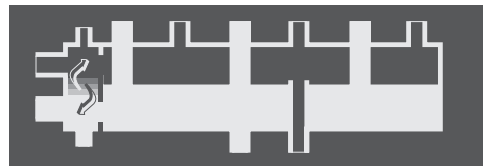

559231

## ACCESSORIES FOR 559 SERIES



**559**

Pair of plugs with gaskets for unused outlets. For 559 and 550 series with 125 mm outlet centre distance.



Code			
559001	1 1/2" M	1	–

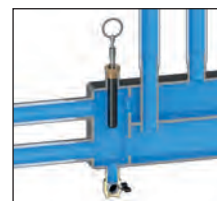

**559**

Pocket with magnetic insert. For 559 series.



Code			
559003	1/2" M	1	–



**COMPACT MANIFOLD - DN 25**

**550 2**

Manifold for heating and cooling systems.  
Steel body. **With pre-formed insulation.**  
Main connections: 1 1/2" M.  
Outlet connections: 1 1/2" F with captive nut.  
Max. working pressure: 6 bar.  
Temperature range: 5-110 °C.  
Complete with steel mounting brackets.

tech. broch. 01355





Code	Outlet centre distance	Max. recommended flow rate m <sup>3</sup> /h		
550220	125 mm	4	1	-

**550 2+1**

Manifold for heating and cooling systems.  
Steel body. **With pre-formed insulation.**  
Main connections: 1 1/2" M.  
Outlet connections: 1 1/2" F with captive nut.  
Max. working pressure: 6 bar.  
Temperature range: 5-110 °C.

tech. broch. 01355





Code	Outlet centre distance	Max. recommended flow rate m <sup>3</sup> /h		
550221	125 mm	4	1	-

**550 3**

Manifold for heating and cooling systems.  
Steel body. **With pre-formed insulation.**  
Main connections: 1 1/2" M.  
Outlet connections: 1 1/2" F with captive nut.  
Max. working pressure: 6 bar.  
Temperature range: 5-110 °C.  
Complete with steel mounting brackets.

tech. broch. 01355





Code	Outlet centre distance	Max. recommended flow rate m <sup>3</sup> /h		
550230	125 mm	4	1	-

**550 4**

Manifold for heating and cooling systems.  
Steel body. **With pre-formed insulation.**  
Main connections: 1 1/2" M.  
Outlet connections: 1 1/2" F with captive nut.  
Max. working pressure: 6 bar.  
Temperature range: 5-110 °C.  
Complete with steel mounting brackets.

tech. broch. 01355





Code	Outlet centre distance	Max. recommended flow rate m <sup>3</sup> /h		
550240	125 mm	4	1	-

**550**

Hydraulic separator for heating and cooling systems.  
For manifolds 550 series DN 25.  
Steel body. **With pre-formed insulation.**  
Main connections: 1 1/2" M.  
Outlet connections: 1 1/2" F with captive nut.  
Max. working pressure: 6 bar.  
Temperature range: 5-110 °C.

tech. broch. 01355



Code	Outlet centre distance	Max. recommended flow rate m <sup>3</sup> /h		
550205	125 mm	4	1	-

**Application diagram of manifold 550 series DN 25**

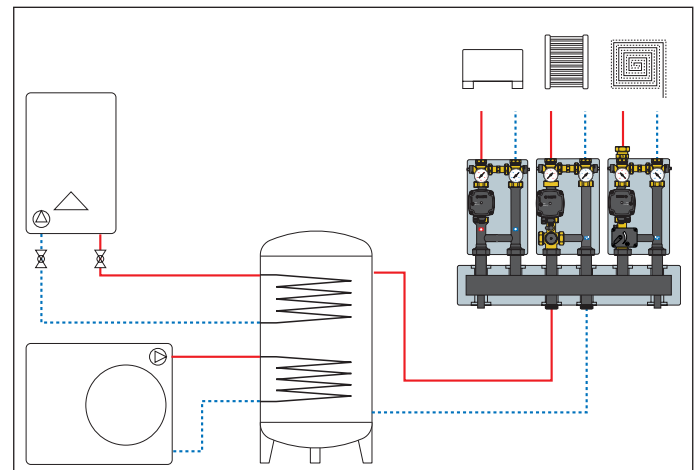

COMPACT MANIFOLD - DN 32

550 2

Manifold for heating and cooling systems.  
Steel body. **With pre-formed insulation.**  
Main connections: 2" M.  
Outlet connections: 1 1/2" F with captive nut.  
Max. working pressure: 6 bar.  
Temperature range: 5-110 °C.  
Complete with steel mounting brackets.



tech. broch. 01355

Code	Outlet centre distance	Max. recommended flow rate m³/h		
550320	125 mm	9	1	-

550 3

Manifold for heating and cooling systems.  
Steel body. **With pre-formed insulation.**  
Main connections: 2" M.  
Outlet connections: 1 1/2" F with captive nut.  
Max. working pressure: 6 bar.  
Temperature range: 5-110 °C.  
Complete with steel mounting brackets.



tech. broch. 01355

Code	Outlet centre distance	Max. recommended flow rate m³/h		
550330	125 mm	9	1	-

550 4

Manifold for heating and cooling systems.  
Steel body. **With pre-formed insulation.**  
Main connections: 2" M.  
Outlet connections: 1 1/2" F with captive nut.  
Max. working pressure: 6 bar.  
Temperature range: 5-110 °C.  
Complete with steel mounting brackets.



tech. broch. 01355

Code	Outlet centre distance	Max. recommended flow rate m³/h		
550340	125 mm	9	1	-

550

tech. broch. 01355



Hydraulic separator for heating and cooling systems.  
For manifolds 550 series DN 32.  
Steel body. **With pre-formed insulation.**  
Main connections: 2" M.  
Outlet connections: 2" F with captive nut.  
Max. working pressure: 6 bar.  
Temperature range: 5-110 °C.

Code	Outlet centre distance	Max. recommended flow rate m³/h		
550305	125 mm	9	1	-

Application diagrams of manifold 550 series DN 32  
Primary connection from the left

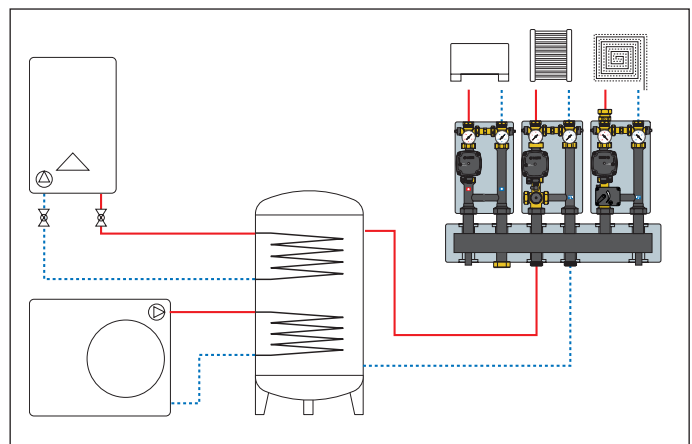

Primary connection from the right

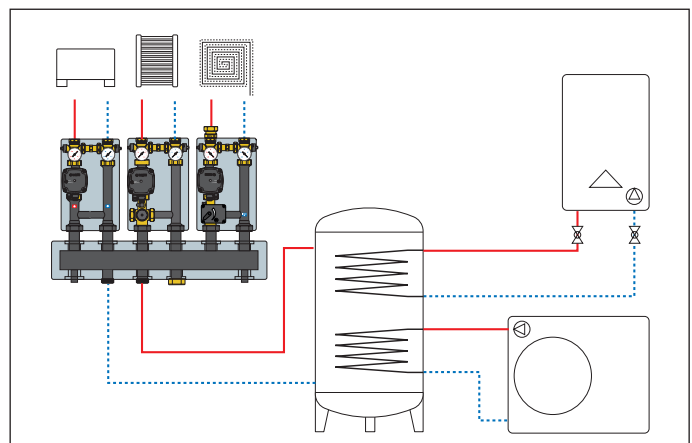

559

Pair of plugs with gaskets for unused outlets.  
For 559 and 550 series with 125 mm outlet centre distance.



Code			
559001	1 1/2" M	1	-

559

Pair of fittings with gaskets.  
For 559 and 550 series with 125 mm outlet centre distance.



Code			
559002	1 1/2" M x 1" M	1	-

**MANIFOLD FOR CENTRAL HEATING SYSTEM**

**550 2**

Manifold for heating and cooling systems. Steel body.  
1 1/4" M main connections.  
Outlet connections: 1 1/2" F with captive nut.  
Max. working pressure: 10 bar.  
Temperature range: 5–110 °C.

tech. broch. 01261



Code	Outlet centre distance		
550020	125 mm	1	-

**550 2+1**

Manifold for heating and cooling systems. Steel body.  
1 1/4" M main connections.  
Outlet connections: 1 1/2" F with captive nut.  
Max. working pressure: 10 bar.  
Temperature range: 5–110 °C.

tech. broch. 01261



Code	Outlet centre distance		
550021	125 mm	1	-

**550 3**

Manifold for heating and cooling systems. Steel body.  
1 1/2" M main connections.  
Outlet connections: 1 1/2" F with captive nut.  
Max. working pressure: 10 bar.  
Temperature range: 5–110 °C.

tech. broch. 01261



Code	Outlet centre distance		
550030	125 mm	1	-

**550 3+1**

Manifold for heating and cooling systems. Steel body.  
1 1/2" M main connections.  
Outlet connections: 1 1/2" F with captive nut.  
Max. working pressure: 10 bar.  
Temperature range: 5–110 °C.

tech. broch. 01261



Code	Outlet centre distance		
550031	125 mm	1	-

**550 4**

Manifold for heating and cooling systems. Steel body.  
1 1/2" M main connections.  
Outlet connections: 1 1/2" F with captive nut.  
Max. working pressure: 10 bar.  
Temperature range: 5–110 °C.

tech. broch. 01261



Code	Outlet centre distance		
550040	125 mm	1	-

Insulation for manifolds for central heating system 550 series. For heating and cooling systems.



Code			
CBN550020	for manifold 2	1	-
CBN550021	for manifold 2+1	1	-
CBN550030	for manifold 3	1	-
CBN550031	for manifold 3+1	1	-
CBN550040	for manifold 4	1	-

**550**

Kit for 550 series manifold pipe connection to 548 series hydraulic separator.



Code			
550001	1 1/4" x 1 1/4"	1	-
550002	1 1/2" x 1 1/4"	1	-
550003	1 1/2" x 1 1/2"	1	-
550004	2" x 1 1/2"	1	-

**559**

Pair of fittings with gaskets. For 559 and 550 series with 125 mm outlet centre distance.



Code			
559002	1 1/2" M x 1" M	1	-



DIRECT SUPPLY UNIT



DN 25





**165**  [tech. broch. 01398](#)  
 Direct supply unit for **heating systems**.  
 With pre-formed insulation.  
 Max. working pressure: 10 bar.  
 Max. working temperature: 100 °C.  
 Supply: 230 V - 50/60 Hz.  
 System side connection: 1" F.  
 Boiler side connection: 1 1/2" M.  
**Outlet centre distance: 125 mm**



RH to LH convertible



Code	Pump	Flow rate with residual head 4 m w.g.		
165600A2L	UPM3S Auto 25-60	1,6 m³/h	1	-





**165**   [tech. broch. 01398](#)  
 Direct supply unit for **heating and cooling systems**.  
 With pre-formed insulation.  
 Max. working pressure: 10 bar.  
 Primary inlet temperature range: 5-100 °C.  
 Supply: 230 V - 50/60 Hz.  
 System side connection: 1" F.  
 Boiler side connection: 1 1/2" M.  
**Outlet centre distance: 125 mm**



RH to LH convertible



Code	Pump	Flow rate with residual head 4 m w.g.		
165640HE3	PARA 25/7	1,6 m³/h	1	-



**165**   [tech. broch. 01398](#)  
 Direct supply unit for **heating and cooling systems**.  
 With pre-formed insulation.  
 Max. working pressure: 10 bar.  
 Primary inlet temperature range: 5-100 °C.  
 Supply: 230 V - 50/60 Hz.  
 System side connection: 1" F.  
 Boiler side connection: 1 1/2" M.  
**Outlet centre distance: 125 mm**



RH to LH convertible

Code	Pump	Flow rate with residual head 4 m w.g.		
165640HE5	EVOSTA2 70/130	1,6 m³/h	1	-



DN 32





**165**  [tech. broch. 01398](#)  
 Direct supply unit for **heating systems**.  
 With pre-formed insulation.  
 Max. working pressure: 10 bar.  
 Max. working temperature: 100 °C.  
 Supply: 230 V - 50/60 Hz.  
 System side connection: 1 1/4" F.  
 Boiler side connection: 1 1/2" M.  
**Outlet centre distance: 125 mm**



RH to LH convertible



Code	Pump	Flow rate with residual head 4 m w.g.		
165601UPM	UPML 25-105	3,4 m³/h	1	-



**165**   [tech. broch. 01398](#)  
 Direct supply unit for **heating and cooling systems**.  
 With pre-formed insulation.  
 Max. working pressure: 10 bar.  
 Primary inlet temperature range: 5-100 °C.  
 Supply: 230 V - 50/60 Hz.  
 System side connection: 1 1/4" F.  
 Boiler side connection: 1 1/2" M.  
**Outlet centre distance: 125 mm**



RH to LH convertible

Code	Pump	Flow rate with residual head 4 m w.g.		
165641HE4	PARA 25/9	2,7 m³/h	1	-

For distribution units fitted for heat metering, refer to Section 12

THERMOSTATIC REGULATING UNIT

DN 25



**166** 🔥 [tech. broch. 01399](#)  
 Thermostatic regulating unit for **heating systems**.  
 With pre-formed insulation.  
 Max. working pressure: 10 bar.  
 Max. working temperature: 100 °C  
 Supply: 230 V - 50/60 Hz.  
 System side connection: 1" F.  
 Boiler side connection: 1 1/2" M.  
**Outlet centre distance: 125 mm**



RH to LH convertible

Code	Pump	Temperature adjustment range	Flow rate with residual head 4 m w.g.		
166600A2L	UPM3S Auto 25-60	25-50 °C	1,4 m³/h	1	-
166605A2L	UPM3S Auto 25-60	40-70 °C	1,4 m³/h	1	-



**166** 🔥 [tech. broch. 01399](#)  
 Thermostatic regulating unit for **heating systems**.  
 With pre-formed insulation.  
 Max. working pressure: 10 bar.  
 Max. working temperature: 100 °C  
 Supply: 230 V - 50/60 Hz.  
 System side connection: 1" F.  
 Boiler side connection: 1 1/2" M.  
**Outlet centre distance: 125 mm**



RH to LH convertible

Code	Pump	Temperature adjustment range	Flow rate with residual head 4 m w.g.		
166600HE3	PARA 25/7	25-50 °C	1,4 m³/h	1	-



**166** 🔥 [tech. broch. 01399](#)  
 Thermostatic regulating unit for **heating systems**.  
 With pre-formed insulation.  
 Max. working pressure: 10 bar.  
 Max. working temperature: 100 °C  
 Supply: 230 V - 50/60 Hz.  
 System side connection: 1" F.  
 Boiler side connection: 1 1/2" M.  
**Outlet centre distance: 125 mm**



RH to LH convertible

Code	Pump	Temperature adjustment range	Flow rate with residual head 4 m w.g.		
166600HE5	EVOSTA2 70/130	25-50 °C	1,4 m³/h	1	-

DN 32



**166** 🔥 [tech. broch. 01399](#)  
 Thermostatic regulating unit for **heating systems**.  
 With pre-formed insulation.  
 Max. working pressure: 10 bar.  
 Max. working temperature: 100 °C  
 Supply: 230 V - 50/60 Hz.  
 System side connection: 1 1/4" F.  
 Boiler side connection: 1 1/2" M.  
**Outlet centre distance: 125 mm**



RH to LH convertible

Code	Pump	Temperature adjustment range	Flow rate with residual head 4 m w.g.		
166601UPM	UPML 25-105	25-50 °C	2,4 m³/h	1	-

MOTORISED REGULATING UNITS

DN 25



**167** tech. broch. 01400  
 Motorised regulating unit for **heating systems**.  
 With pre-formed insulation.  
 Regulation with sector three-way valve.  
 Max. working pressure: 10 bar.  
 Max. working temperature: 100 °C  
 System side connection: 1" F.  
 Boiler side connection: 1 1/2" M.  
**Outlet centre distance: 125 mm**



RH to LH convertible

**Actuator with 3-point control signal**

Supply: 230 V.  
 Operating time: 150 s (90° rotation).  
 Can be connected to digital regulators code 161010 and 1520 series.

Code	Pump	Flow rate with residual head 4 m w.g.		
167652HE1	UPM3S Auto 25-60	1,4 m³/h	1	-

**Actuator with 0(2)-10 V control signal**

Supply: 24 V.  
 Operating time: 75 s (90° rotation).  
 Feedback signal: 0-10 V.  
 Can be connected to digital regulators code 161010 (for actuator electric supply use 230 V / 24 V transformer).

Code	Pump	Flow rate with residual head 4 m w.g.		
167654HE1	UPM3S Auto 25-60	1,4 m³/h	1	-



**167** tech. broch. 01400  
 Motorised regulating unit for **heating and cooling systems**.  
 With pre-formed insulation.  
 Regulation with sector three-way valve.  
 Max. working pressure: 10 bar.  
 Primary inlet temperature range: 5-100 °C.  
 System side connection: 1" F.  
 Boiler side connection: 1 1/2" M.  
**Outlet centre distance: 125 mm**



RH to LH convertible

**Actuator with 3-point control signal**

Supply: 230 V.  
 Operating time: 150 s (90° rotation).  
 Can be connected to digital regulators code 161010 and 1520 series.

Code	Pump	Flow rate with residual head 4 m w.g.		
167652HE3	PARA 25/7	1,4 m³/h	1	-

**Actuator with 0(2)-10 V control signal**

Supply: 24 V.  
 Operating time: 75 s (90° rotation).  
 Feedback signal: 0-10 V.  
 Can be connected to digital regulators code 161010 (for actuator electric supply use 230 V / 24 V transformer).

Code	Pump	Flow rate with residual head 4 m w.g.		
167654HE3	PARA 25/7	1,4 m³/h	1	-

DN 32



**167** tech. broch. 01400  
 Motorised regulating unit for **heating systems**.  
 With pre-formed insulation.  
 Regulation with sector three-way valve.  
 Max. working pressure: 10 bar.  
 Max. working temperature: 100 °C  
 System side connection: 1 1/4" F.  
 Boiler side connection: 1 1/2" M.  
**Outlet centre distance: 125 mm**



RH to LH convertible

**Actuator with 3-point control signal (see code 167652HE1)**

Code	Pump	Flow rate with residual head 4 m w.g.		
167662HE2	UPML 25-105	3,7 m³/h	1	-

**Actuator with 0(2)-10 V control signal (see code 167654HE1)**

Code	Pump	Flow rate with residual head 4 m w.g.		
167664HE2	UPML 25-105	3,7 m³/h	1	-



**167** tech. broch. 01400  
 Motorised regulating unit for **heating and cooling systems**.  
 With pre-formed insulation.  
 Regulation with sector three-way valve.  
 Max. working pressure: 10 bar.  
 Primary inlet temperature range: 5-100 °C.  
 System side connection: 1 1/4" F.  
 Boiler side connection: 1 1/2" M.  
**Outlet centre distance: 125 mm**



RH to LH convertible

**Actuator with 3-point control signal (see code 167652HE3)**

Code	Pump	Flow rate with residual head 4 m w.g.		
167662HE4	PARA 25/9	2,2 m³/h	1	-

**Actuator with 0(2)-10 V control signal (see code 167654HE3)**

Code	Pump	Flow rate with residual head 4 m w.g.		
167664HE4	PARA 25/9	2,2 m³/h	1	-

**ACCESSORIES FOR UNITS 165 - 166 - 167 SERIES**



**165**  
Hydraulic separator kit  
for units 165, 166 and 167 series.  
DN 25.

Code			
<b>165010</b>	1 1/2" F x 1" F	1	-



**165**  
Mounting bracket in stainless steel  
for units 165, 166 and 167 series.

Code			
<b>165001</b>		1	-



**519**  
Differential by-pass valve  
for units 165, 166 and 167 series.  
Max. working pressure: 10 bar.  
Max. working temperature: 100 °C.

Code	Setting range m w.g.		
<b>519006</b>	1-6	1	-



**165**  
Safety thermostat kit  
for units 165, 166 and 167 series.  
Protection class: IP 65.  
M4 threading.

Code		Setting		
<b>165004</b>	Max. temperature safety thermostat	55 °C ± 3	1	-
<b>165007</b>	Min. temperature safety thermostat	10 °C ± 3	1	-



**165**  
Pair of eccentric tailpieces  
for units 165, 166 and 167 series.  
Centre distance: 105-145 mm.

Code			
<b>165006</b>	1 1/2" F x 1" F	1	-



**165**  
Sensor holder extension  
for units 165, 166 and 167 series.  
Side connections:  
M4 F x M4 F x 1/8" F x 1/4" F.

Code			
<b>165003</b>	1" M x 1" F	1	-



**165**  
Female union with captive nut  
complete with gasket  
for units 165, 166 and 167 series.

Code			
<b>165002</b>	1 1/2" F x 1" F	1	-

SPARE PARTS FOR REGULATING UNITS 165, 166 AND 167 SERIES



UPM3S Auto 25-60 spare part.  
Complete with supply cable.



Code			
<b>F0001252</b>	UPM3S Auto 25-60 pump	1	-



UPML 25-105 spare part.  
Complete with supply cable.



Code			
<b>F19486</b>	UPML 25-105 pump	1	-



PARA 25/7 spare part.  
Complete with supply cable.



Code			
<b>F19441</b>	PARA 25/7 pump	1	-



PARA 25/9 spare part.  
Complete with supply cable.



Code			
<b>F0001584</b>	PARA 25/9 pump	1	-



EVOSTA2 70/130 spare part.  
Complete with supply cable.



Code			
<b>F0002041</b>	EVOSTA2 70/130 pump	1	-



**166**

Thermostatic mixing valve.  
Max. working pressure: 10 bar.  
Connections:  
1 1/2" M x 1 1/4" M x 1 1/2" F with captive nut.

Code	Temperature adjustment range	Kv (m³/h)		
<b>166001</b>	25–50 °C	4,1	1	-
<b>166005</b>	40–70 °C	4,1	1	-



Three-way sector mixing valve, threaded.  
Brass body.  
PN 10.  
Max. working pressure: 10 bar.  
Max. Δp: 1 bar.  
Temperature range: 5–110 °C.

Code	Kv (m³/h)	Use		
<b>F0001334</b>	6,3	16765.HE1/HE3	1	-
<b>F0001335</b>	10,0	16766.HE2/HE4	1	-



**6370**

[tech. broch. 01353](#)

Actuator for unit 167 series.  
Supply: 230 V - 50 Hz or 24 V.  
Control signal:  
637042: 3 points,  
637044: 0(2)–10 V, 0(4)–20 mA, 0–5 V, 5–10 V.  
Power consumption: 637042: 3 VA, 637044: 2 W.  
Protection class: IP 44.  
Rotation 90°.  
Operating time: 150 s (code 637044 - 75 s).  
Ambient temperature range: 0–55 °C.  
Storage temperature range: -10–70 °C.  
Supply cable length: 1,5 m.



Code	Tension V	Control signal	Actuator torque (N-m)		
<b>637042</b>	230	3 points	5	1	-
<b>637044</b>	24	0(2)–10 V	5	1	-



Spare probe pockets for 167 series.

Code			
<b>F0001592</b>			

TEMPERATURE REGULATORS



161

Digital regulator with synoptic diagram for **heating and cooling** complete with immersion flow probes with pocket and Pt1000 Ø 6 mm return probe (pocket to be chosen according to the pipe, see accessories).  
Optional outside compensated probe.  
Temperature adjustment range: 5–95 °C.  
Supply: 230 V - 50/60 Hz.  
Control signal: 3-point, 0–10 V.  
Protection class: IP 20 / EN 60529.  
Probe cable length: 1,5 m.



Code

161010



1 -



161

Outside temperature probe.

Code

161002



1 -



161

Pressure switch with preconnected pin.  
Working range: 0,5–10 bar.  
Max. working temperature: 100 °C.  
Cable length: 1 m.

Code

161003



1 -



161

Dew point detector.  
Working range: 30–100 RH %.

Code

161004



1 -



161

Remote regulator.  
Functions:  
- translation of regulation curves from +15 K to -15 K  
- max. temperature  
- position OFF.

Code

161005



1 -

Accessories for regulator code 161010.

Code

161012 Pt1000 contact probe for pipes Ø 6 mm, cable L 2,5 m

161013 immersion pocket for Pt1000 probe 1/2" M, 60 mm

161014 immersion pocket for Pt1000 probe 1/2" M, 100 mm

161015 Pt1000 probe Ø 6 mm - L 20 mm, cable L 1,5 m

161006 Pt1000 probe Ø 6 mm - L 45 mm, cable L 2,5 m



1520

Outside compensated digital temperature regulator for **heating**.  
Complete with contact flow probe and outside probe.  
Adjustment range: 20–90 °C.  
Supply: 230 V - 50/60 Hz.  
Control signal: 3-point.  
Protection class: IP 40.



Code

152001 1 channel

152002 2 channels

152003 3 channels



1 -  
1 -  
1 -



1520

Digital temperature controller for **heating and cooling**.  
Complete with flow probe, outside probe and max. relative humidity probe.  
Supply: 230 V - 50/60 Hz.  
Power consumption: 5,5 VA.  
Protection class: IP 40.



Code

152021 1 channel





1 -

**STRAINER FOR HEATING AND DOMESTIC WATER SYSTEMS**



**577**

Y-strainer.  
Bronze body,  
1/2"–2": PN 16,  
2 1/2"–3": PN 10.  
Female connections.  
Temperature range: -20–110 °C.  
Max. percentage of glycol: 30 %.  
Strainer on stainless steel stretched plate.

Code		Mesh size Ø (mm)	Kv (m³/h)		
<b>577004</b>	1/2"	0,40	2,5	1	–
<b>577005</b>	3/4"	0,40	3,9	1	–
<b>577006</b>	1"	0,40	7	1	–
<b>577007</b>	1 1/4"	0,47	16	1	–
<b>577008</b>	1 1/2"	0,47	24	1	–
<b>577009</b>	2"	0,53	35	1	–
<b>577020</b>	2 1/2"	0,53	57	1	–
<b>577030</b>	3"	0,53	73	1	–



**Further strainers for domestic water at page 230**

**STRAINER FOR HEATING SYSTEMS**

**579**

Y strainer for heating systems.  
Ductile cast iron body , blue epoxy coating.  
Max. working pressure: 16 bar.  
Temperature range: -10–100 °C.  
Max. percentage of glycol: 50 %.  
Flanged connections PN 16.  
To be coupled with flat counterflanges EN 1092-1.  
Filtering mesh in stainless steel AISI 304.



Code		Mesh size Ø (mm)	Kv (m³/h)		
<b>579051</b>	DN 50	1	28	1	–
<b>579061</b>	DN 65	1	37,2	1	–
<b>579081</b>	DN 80	1	62,2	1	–
<b>579101</b>	DN 100	1,6	149	1	–
<b>579121</b>	DN 125	1,6*	320	1	–
<b>579151</b>	DN 150	1,6*	367	1	–
<b>579201</b>	DN 200	1,6*	652	1	–
<b>579251</b>	DN 250	2*	844	1	–

\*Rhomboidal reinforcing mesh





## COMPONENTS FOR HEAT PUMP SYSTEMS

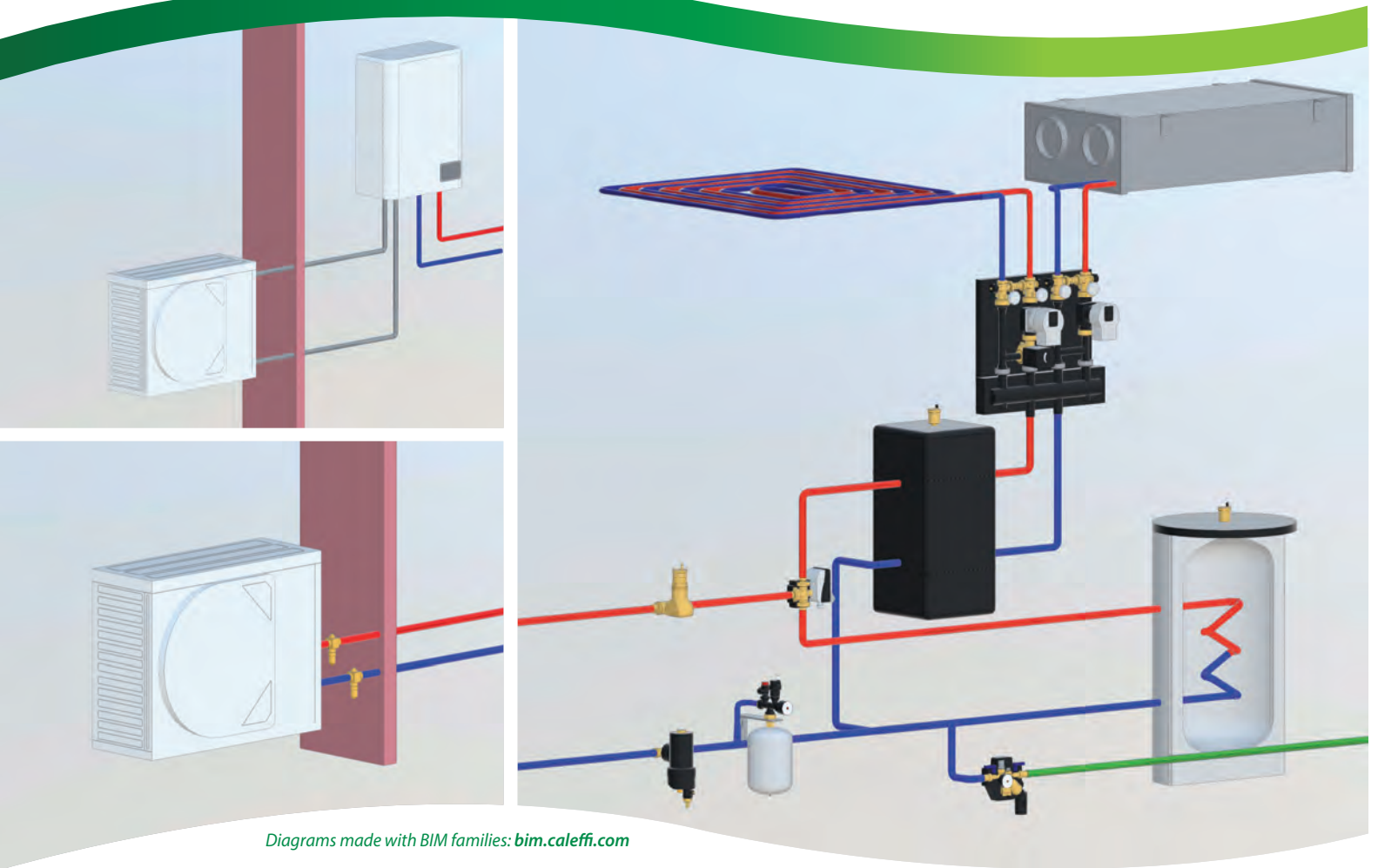

Diagrams made with BIM families: [bim.caleffi.com](http://bim.caleffi.com)

- Antifreeze protection, iStop®**
- Motorised three-way ball diverter valves**
- Semi-automatic self-cleaning magnetic filter CALEFFI XF**
- High-efficiency deaerator for heat pump systems CALEFFI HED®**
- Multifunction device in technopolymer with dirt separator and strainer**
- Deaerator-dirt separator with magnet**
- Instrument holder in technopolymer material**
- Differential by-pass valve**
- Balancing valve with flow meter**
- Inertial hydraulic separator for heat pump**
- Wall-mounted inertial hydraulic separator for hybrid systems**
- Changeover and distribution unit for radiant panel/fan-coil system**

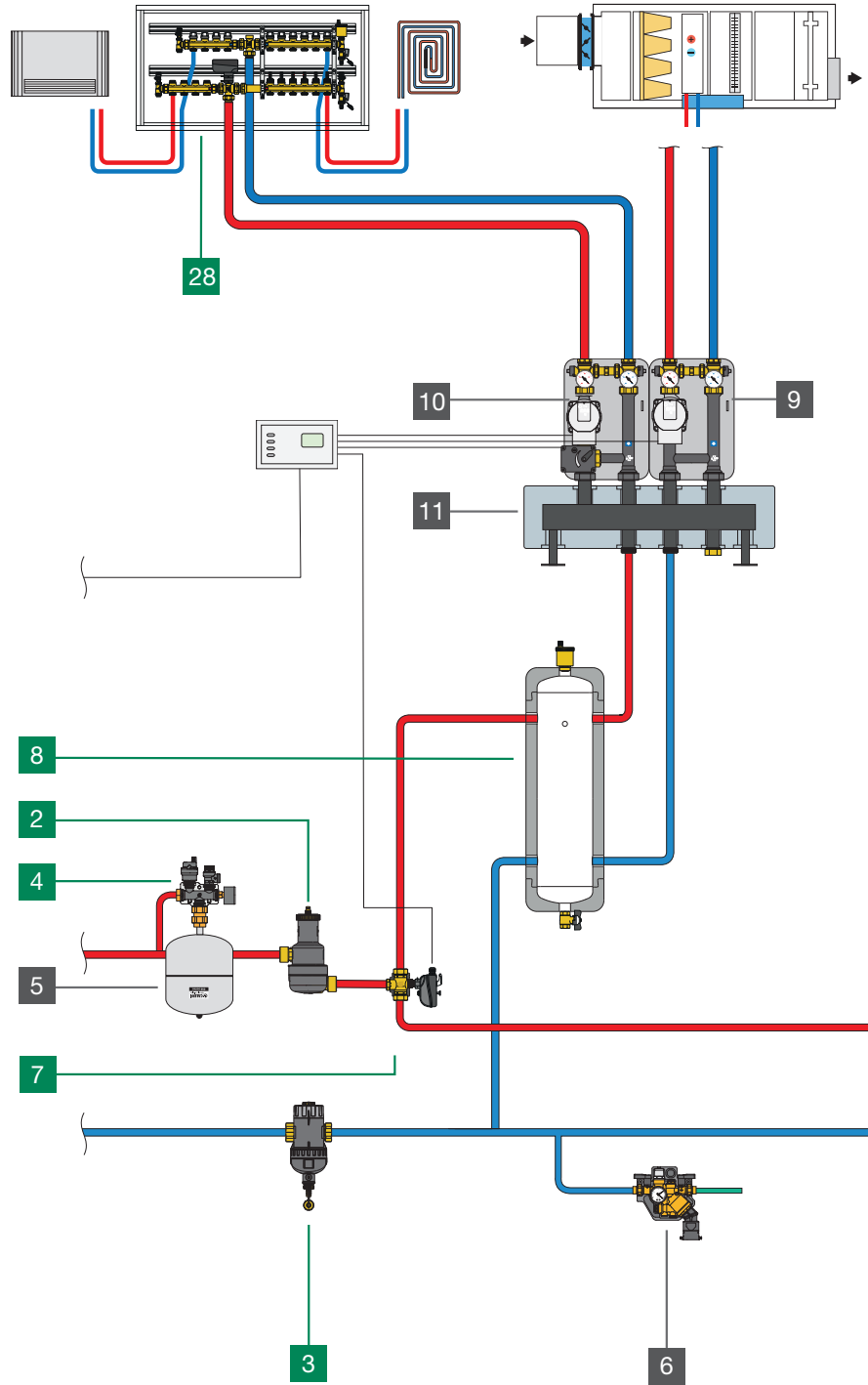
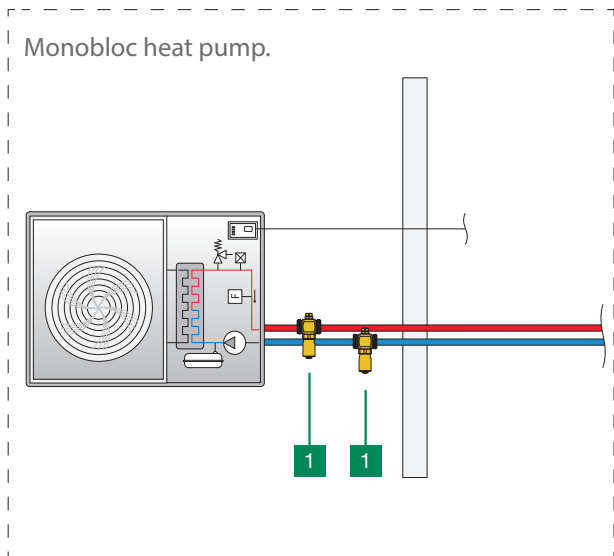
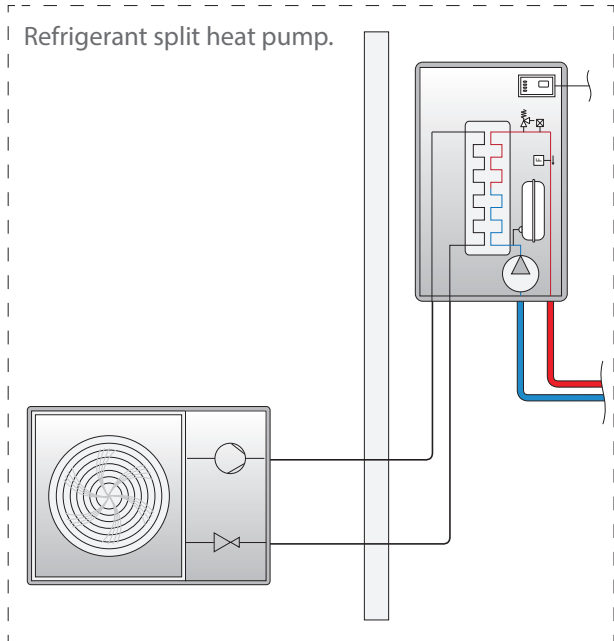

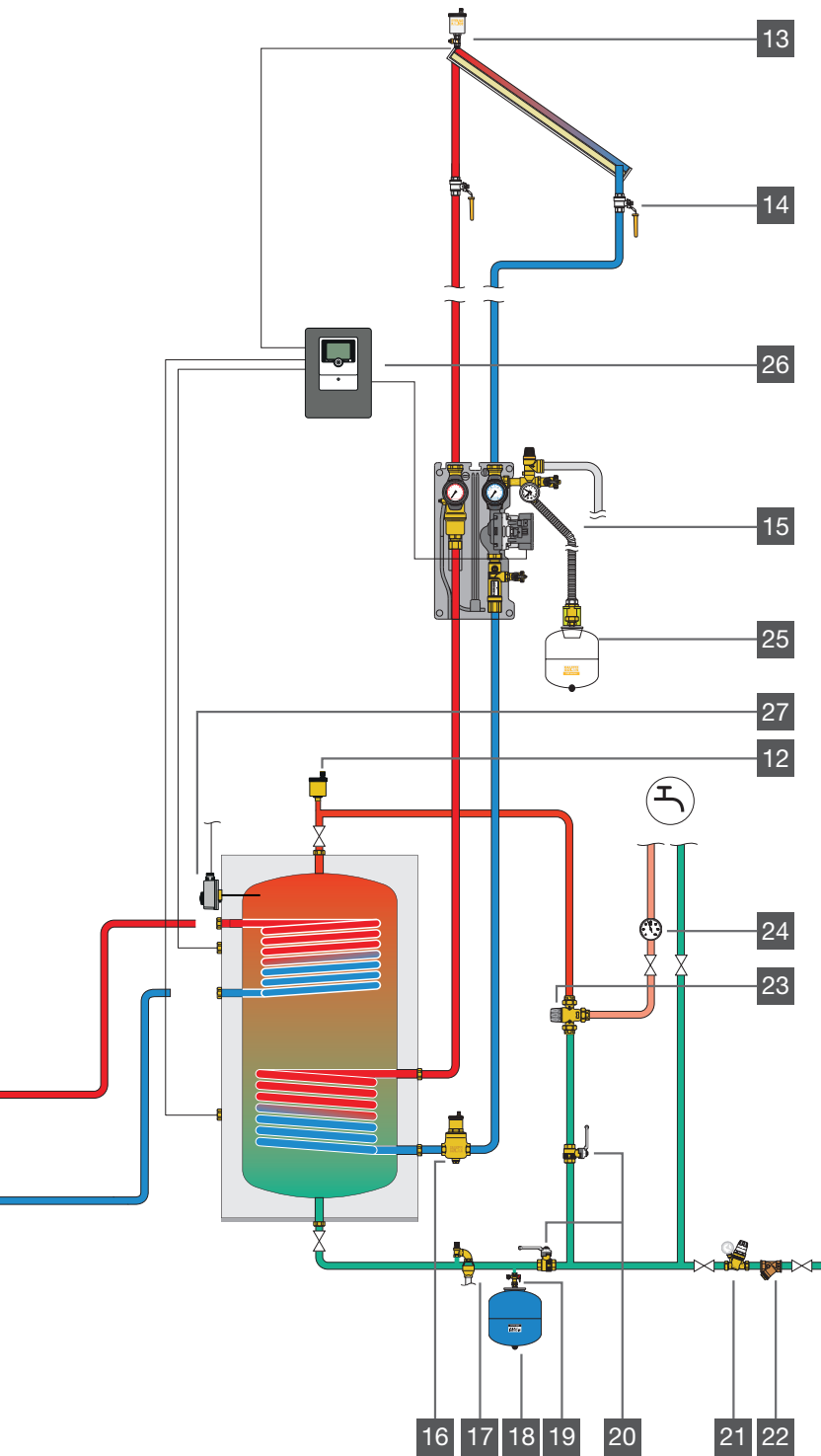

- 1 Series 108 Antifreeze valve
- 2 Series 5516 High-efficiency deaerator CALEFFI HED®
- 3 Series 577 CALEFFI XF semi-automatic self-cleaning magnetic filter
- 4 Series 305 Technopolymer instrument holder manifold
- 5 Series 556 Welded expansion vessel for heating systems
- 6 Series 580 Automatic compact filling unit with BA type backflow preventer, shut-off valves, strainer, pressure test ports, pressure reducing valve
- 7 Series 638 3-way motorised ball valve
- 8 Series 5485 Buffer tank for heat pump systems
- 9 Series 165 Direct supply unit
- 10 Series 167 Motorised regulating unit
- 11 Series 550 Manifold for central heating system
- 12 Series 5020 MINICAL® automatic air vent
- 13 Series 250 Automatic air vent for solar thermal systems, complete with shut-off cock
- 14 Series 240 Ball valve for solar thermal systems
- 15 Series 279 Circulation unit for solar heating systems
- 16 Series 251 Deaerator for solar heating systems
- 17 Series 531 Safety relief valve for domestic water systems
- 18 Series 568 Welded expansion vessel for domestic systems
- 19 Series 5580 Shut-off ball valve for expansion vessels, with drain cock
- 20 Series 3230 Ball valve with check valve
- 21 Series 5350 Pressure reducing valve
- 22 Series 577 Oblique filter
- 23 Series 5231 Adjustable thermostatic mixing valve
- 24 Series 688 Temperature gauge
- 25 Series 259 Welded expansion vessel for solar thermal systems
- 26 Series 278 DeltaSol® SLL digital regulator
- 27 Series 622 Immersion thermostat, adjustable
- 28 Series 664 Changeover and distribution unit radiant panel/fan-coil system

Caleffi S.p.A. declines any responsibility deriving from improper use of the data provided in this document. This document should not be considered as a replacement for the technical heating design.

**TABLE FOR SIZING COMPONENTS FOR HEAT PUMP SYSTEMS**

Nominal power HP [kW]	3	4	5	6	7	8	9	10	11	12	14	16	18	22	25		
Max. set flow rate [l/h] ( $\Delta T = 5\text{ }^{\circ}\text{C}$ )	516	688	860	1.032	1.204	1.376	1.548	1.720	1.892	2.064	2.408	2.752	3.096	3.784	4.300		
Nominal pipe diameter*	3/4"	3/4"	1"	1"	1"	1"	1"	1"	1 1/4"	1 1/4"	1 1/4"	1 1/4"	1 1/2"	1 1/2"	1 1/2"		
<b>iStop®</b>		<b>108301</b> ( $\varnothing 28$ )											-				
		<b>108601</b> (1")					<b>108701</b> (1 1/4")					<b>108801</b> (1 1/2")					
		<b>108611</b> (1")					<b>108711</b> (1 1/4")										
		<b>108622</b> (1")					-										
		<b>108322</b> ( $\varnothing 28$ )											-				
<b>DIRTMAGPLUS®</b>		<b>545372</b> ( $\varnothing 22$ )		<b>545373</b> ( $\varnothing 28$ )			-										
	$\Delta p^{**}$ [kPa]	0,59	1,05	1,65	2,37	3,23	-										
		<b>545375</b> (3/4")		<b>545376</b> (1")			<b>545377</b> (1 1/4")					-					
	$\Delta p^{**}$ [kPa]	0,59	1,05	1,65	2,37	3,23	2,06	2,6	3,21	3,88	4,62	-					
<b>CALEFFIXF</b>		<b>577200</b> ( $\varnothing 22$ )		<b>577300</b> ( $\varnothing 28$ )						-							
	$\Delta p^{**}$ [kPa]	0,33	0,58	0,67	0,97	1,31	1,71	2,17	2,66	-							
		<b>577500</b> (3/4")		<b>577600</b> (1")						<b>577700</b> (1 1/4")			<b>577800</b> (1 1/2")				
	$\Delta p^{**}$ [kPa] (100 %)	0,25	0,45	0,65	0,93	1,27	1,66	2,09	2,58	3,13	3,73	5,06	6,61	1,81	2,7	3,5	
	$\Delta p^{**}$ [kPa] (50 %)	-												0,6	0,89	1,16	
<b>CALEFFIHED®</b>		<b>551602</b> ( $\varnothing 22$ )								<b>551603</b> ( $\varnothing 28$ )				-			
	$\Delta p$ [kPa]	0,18	0,33	0,51	0,74	1,01	1,31	1,66	2,05	2,49	2,96	4,03	5,26	-			
		<b>551606</b> (1")								<b>551607/551617</b> (1 1/4")				-			
	$\Delta p^{**}$ [kPa] (100 %)	0,18	0,33	0,51	0,74	1,01	1,31	1,66	2,05	2,49	2,96	4,03	5,26	-			
<b>DISCAL®</b>		<b>551005</b> (3/4")		<b>551006</b> (1")					<b>551007</b> (1 1/4")				<b>551008</b> (1 1/2")				
	$\Delta p$ [kPa]	0,25	0,45	0,65	0,93	1,27	1,66	2,09	2,58	3,13	3,73	5,06	6,61	1,81	2,7	3,5	

\* Pipe pressure drop  $r \sim 20\text{-}22$  mm w.g./m (50 °C)

\*\* With clean filter

**TABLE FOR SIZING COMPONENTS FOR HEAT PUMP SYSTEMS**

HP nominal power [kW]		3	4	5	6	7	8	9	10	11	12	14	16	18	22	25			
Max. set flow rate [l/h] ( $\Delta T = 5\text{ }^\circ\text{C}$ )		516	688	860	1.032	1.204	1.376	1.548	1.720	1.892	2.064	2.408	2.752	3.096	3.784	4.300			
Nominal pipe diameter*		3/4"	3/4"	1"	1"	1"	1"	1"	1"	1 1/4"	1 1/4"	1 1/4"	1 1/4"	1 1/2"	1 1/2"	1 1/2"			
DISCALDIRTMAG®		546402 ( $\varnothing 22$ )		546403 ( $\varnothing 28$ )															
	$\Delta p$ [kPa]	0,24	0,43	0,67	0,97	1,31	1,72												
		546405 (3/4")		546406 (1")				546407 (1 1/4")											
	$\Delta p$ [kPa]	0,24	0,43	0,67	0,97	1,31	1,72	2,17	2,68	3,25	3,86								
5485		548520		548525				548530				548550							
		548551																	
6445		644562/66																	
	$\Delta p$ [kPa]	0,33	0,58	0,91	1,31	1,79	2,34	2,94	3,65										
638										638373				638383					
	$\Delta p$ [kPa]													0,59	0,7	0,95	1,24	0,43	0,65
519		519500 (3/4", 1-6 m w.g.) - 519504 (3/4", 10-40 m w.g.)																	
518		518015 (3/4", 1-6 m w.g.)																	
		518002 ( $\varnothing 22$ , 1-6 m w.g.)																	
		518500 (3/4", 1-6 m w.g.)																	
580		580011																	

\* Pipe pressure drop  $r \sim 20-22$  mm w.g./m (50 °C)

ANTIFREEZE PROTECTION

108 iStop® tech. broch. 01376



Antifreeze valve. Brass body.  
 Max. working pressure: 10 bar.  
 Working temperature range: 0–65 °C.  
 Ambient temperature range: -30–60 °C.  
 Opening temperature: 3 °C.  
 Closing temperature: 4 °C.

Threaded connections

Code			
108601	1"	1	25
108701	1 1/4"	1	20
108801	1 1/2"	1	20

Compression ends

Code			
108301	∅ 28	1	20

**NEW** 108 iStop®PLUS tech. broch. 01419



Compact antifreeze valve. Brass body.  
 Max. working pressure: 10 bar.  
 Working temperature range: 0–90 °C.  
 Ambient temperature range: -30–60 °C.  
 Opening temperature: 3 °C.  
 Closing temperature: 4 °C.



Threaded connections

Code			
108622	1"	1	25

Compression ends

Code			
108322	∅ 28	1	20

Function

The antifreeze valve 108 series allows drainage of the medium in the circuit when the circuit temperature reaches an average value of 3 °C.

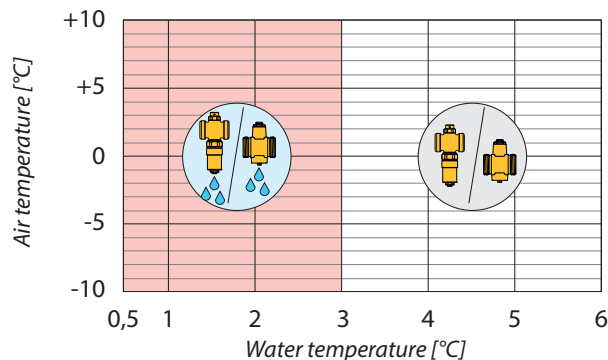

ANTIFREEZE PROTECTION WITH AIR SENSOR

108 iStop® tech. broch. 01376



Antifreeze valve with air sensor.  
 Brass body.  
 Max. working pressure: 5 bar.  
 Working temperature range: 0–65 °C.  
 Ambient temperature range: -30–60 °C.

Antifreeze function (water sensor).  
 Opening temperature: 3 °C.  
 Closing temperature: 4 °C.

Enabling of antifreeze function with low outside air temperature < 5 °C.

PATENT PENDING.

Code

Code			
108611	1"	1	25
108711	1 1/4"	1	20

Application diagrams of antifreeze valve with air sensor 108 series

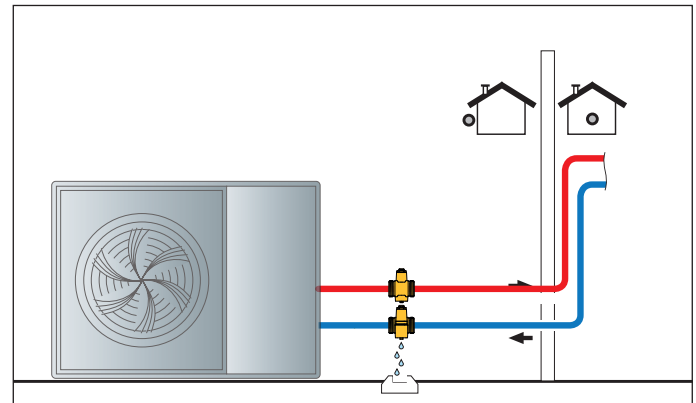

Operating principle

The antifreeze valve 108 series is a mechanical protection system that discharge the water contained in the hydronic system. When the temperature of the water in the pipe drops below 3 °C, the antifreeze valve opens and drains. In outside temperature conditions over 5 °C, antifreeze valve intervention is inhibited by the air temperature sensor. This prevents the valve from cutting in during operation in cooling mode during the summer.

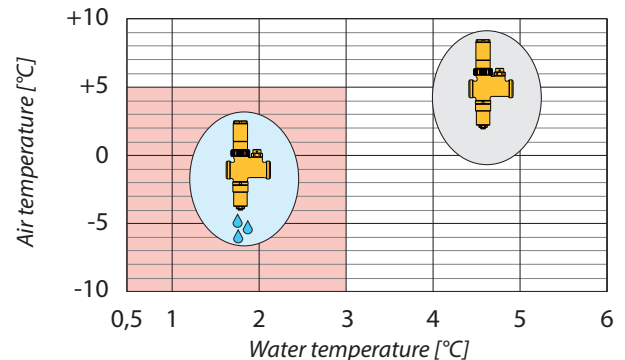

MOTORISED THREE-WAY BALL DIVERTER VALVES



6445

tech. broch 01392

Motorised three-way ball valve.  
With insulation kit for **heating and conditioning systems**.  
With auxiliary microswitch.  
Supply: 230 V (AC).  
Max. working pressure: 10 bar.  
Max. Δp: 10 bar.  
Temperature range: -5–110 °C.  
Ambient temperature range: 0–55 °C.  
Power consumption: - 644562: 4 VA  
- 644566: 8 VA

Auxiliary microswitch contact rating:  
0,8 A (230 V).  
Protection class: IP 54.  
**90° rotation**



Code	Operating time	Supply voltage V	Kv (m³/h)		
644562 1"	40 s	230	9	1	–
644566 1"	10 s	230	9	1	–



638

tech. broch. 01196

Motorised three-way ball valve.  
With insulation kit for **heating and conditioning systems**.  
Supply: 230 V (AC).  
Max. working pressure: 16 bar.  
Max. Δp: 10 bar.  
Temperature range: -10–110 °C.  
Ambient temperature range: -10–55 °C.  
**With auxiliary microswitch**.  
Power consumption: 6 VA.  
Auxiliary microswitch contact rating:  
6 (2) A - 230 V (AC).  
Protection class: IP 65.  
Operating time: 50 s (**90° rotation**).



Code	Operating time	Supply voltage V	Kv (m³/h)		
638373 1 1/4"	50 s	230	24,7	1	–
638383 1 1/2"	50 s	230	47	1	–

**NEW** 6440

tech. broch 01131



3-contact control spare actuator for motorised ball zone valves 6445 series.  
Supply: 230 V (AC).



Code	Operating time	Supply voltage V		
644022	40 s	230	1	10
644032	10 s	230	1	10

Operating diagram for 638 series valve - with "T" drilling

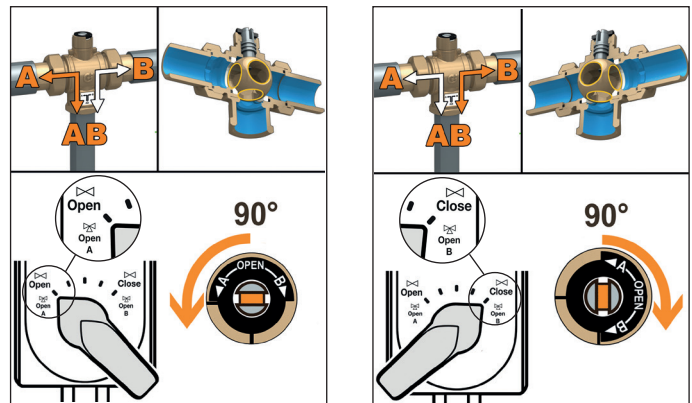

Wiring diagram for valves 6445 series, with 3-contact actuator.

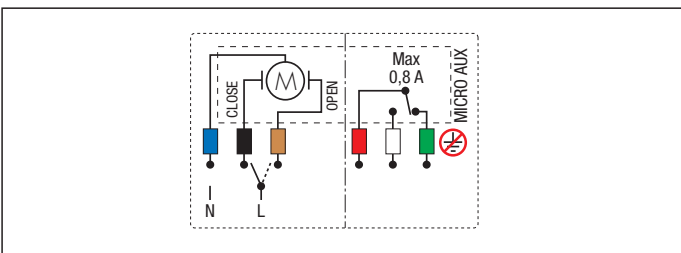

Spare actuator for motorised ball zone valves 638 series.  
90° rotation.



Code	Supply voltage V		
638012	230	1	–



Insulation kit for heating and cooling systems.  
Medium temperature range: -10–110 °C.  
For motorised three-way ball valves 638 series.

Code	Use		
CBN638173	1 1/4"	1	–
CBN638183	1 1/2"	1	–

**SEMI-AUTOMATIC SELF-CLEANING MAGNETIC FILTER**

**577  
CALEFFI XF**

tech. broch. 01391



Semi-automatic self-cleaning magnetic filter.  
Technopolymer body.  
**Female connections.**  
**Adjustable for horizontal and vertical pipes.**  
Drain cock with hose connection.

Max. working pressure: 3 bar.  
Temperature range: 0–90 °C.  
Strainer mesh size  $\varnothing = 0,16$  mm.

**PCT**  
INTERNATIONAL APPLICATION PENDING

**577  
CALEFFI XF**

tech. broch. 01391



Semi-automatic self-cleaning magnetic filter **complete with by-pass.**  
Technopolymer body.  
**Female connections.**  
**Adjustable for horizontal and vertical pipes.**  
Drain cock with hose connection.

Max. working pressure: 3 bar.  
Temperature range: 0–90 °C.  
Strainer mesh size  $\varnothing = 0,16$  mm.

**PCT**  
INTERNATIONAL APPLICATION PENDING

**Threaded connections**

Code			
<b>577500</b>	3/4"	1	-
<b>577600</b>	1"	1	-
<b>577700</b>	1 1/4"	1	-

**Compression ends**

Code			
<b>577200</b>	$\varnothing 22$	1	-
<b>577300</b>	$\varnothing 28$	1	-



Insulation for semi-automatic self-cleaning magnetic filter.

Code	Use		
<b>CBN577500</b>	577500/600/700	1	-
<b>CBN577800</b>	577800/900	1	-

**Cleaning the filter mesh**

To clean the CALEFFI XF filter with the circulator stationary, there is no need to disassemble the component because it contains a mechanism with brushes to clean the filter mesh.

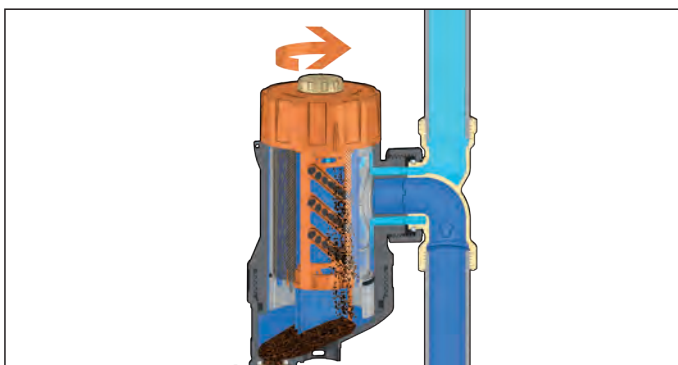

Code			
<b>577800</b>	1 1/2"	1	-
<b>577900</b>	2"	1	-

**Adjustable by-pass**

Sizes DN 40 (code 577800, 1 1/2") and DN 50 (code 577900, 2") are equipped with a by-pass that allows the limitation of the flow rate passing through the device by up to 50%, thereby increasing the Kv value.  
We recommend 100% filtration during filling and for the first weeks of system operation. Then, during the "maintenance" phase, the device can be set to function as a by-pass to achieve a higher Kv.

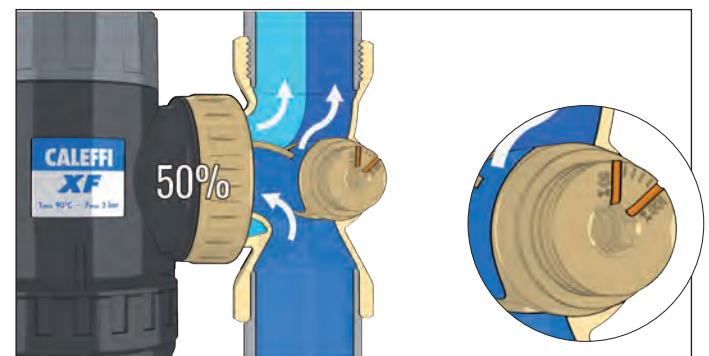
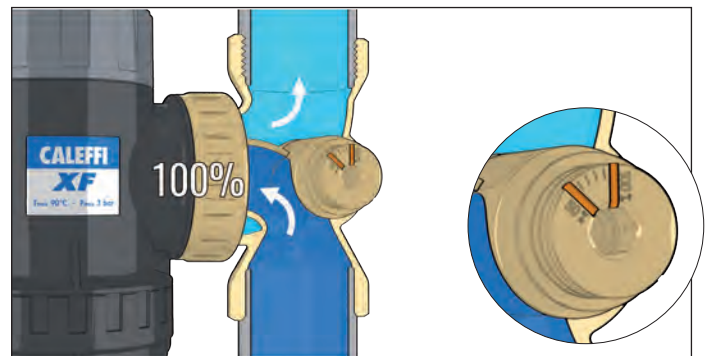



HIGH-EFFICIENCY DEAERATOR FOR HEAT PUMP SYSTEMS

NEW

5516  
CALEFFI HED®

tech. broch 01416

High-efficiency deaerator.  
Technopolymer body.  
**Adjustable for horizontal, vertical and angled installations.**  
With hygroscopic safety cap.  
Max. working pressure: 3 bar.  
Temperature range: 0–90 °C.  
PATENT PENDING.

PCT  
INTERNATIONAL  
APPLICATION  
PENDING



Threaded connections

Code			
551606	1" F	1	-
551607	1 1/4" F	1	-
551617	1 1/4" M	1	-

Compression ends

Code			
551602	Ø 22	1	-
551603	Ø 28	1	-



Insulation  
for high-efficiency deaerators.

Code	Use		
CBN551602	551606/607	1	-



Pressure gauge.

Code	bar	Conn.	Position	Ø		
F0002253	0–4	clip	central	50	1	1

Horizontal installation

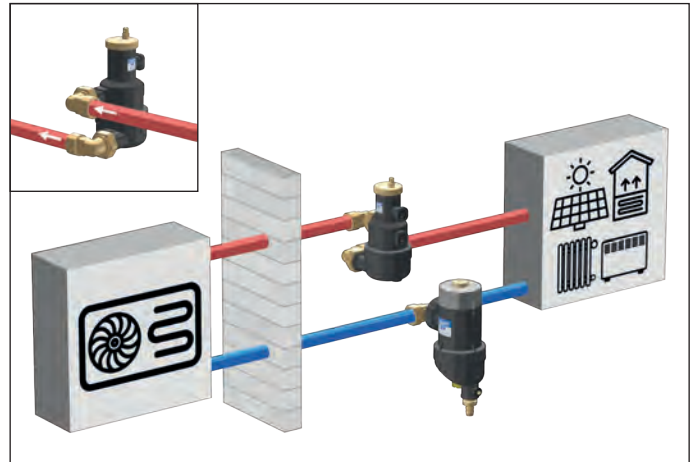

Vertical installation

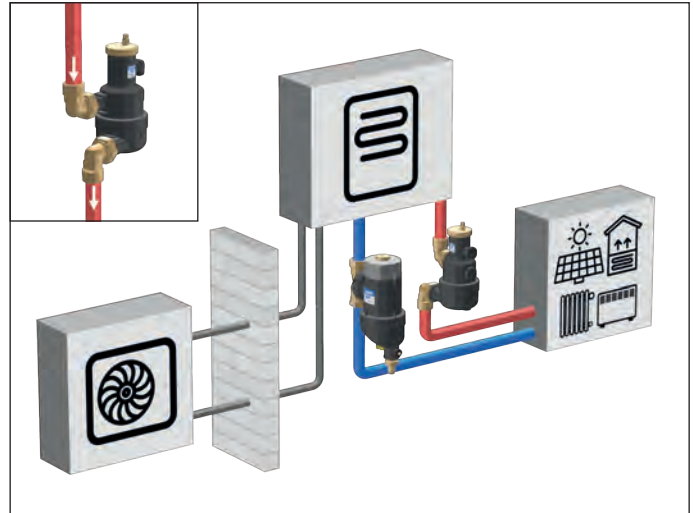

Angled installation

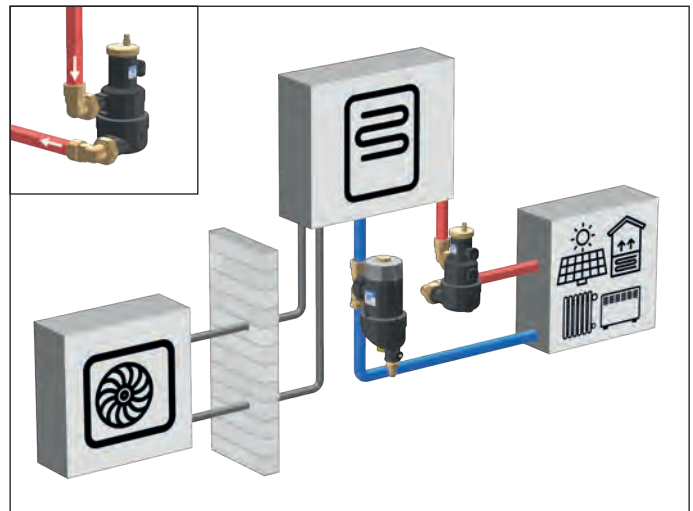

**MULTIFUNCTION DEVICE WITH DIRT SEPARATOR AND STRAINER**



**5453 DIRTMAG PLUS** tech. broch. 01258

Multifunction device with dirt separator and strainer. Specific for the complete cleaning of the hydraulic circuit, to protect continuously generator and components. Technopolymer body. Dirt separator with tecnopolimer internal element, **with magnet**. Two inspectable strainers with stainless steel mesh: 1 for initial cleaning (blue colour) already installed, 1 for maintenance (grey colour) in package. Shut-off valves with nuts, brass body. **Female connections and Ø 22 and Ø 28 mm with compression ends. Adjustable for horizontal, vertical or 45° pipes.** Drain cock with hose connection. Max. working pressure: 3 bar. Temperature range: 0–90 °C.

PCT INTERNATIONAL APPLICATION PENDING

**Threaded connections**

Code			
545375	3/4"	1	5
545376	1"	1	5
545377	1 1/4"	1	5

**Compression ends**

Code			
545372	Ø 22	1	5
545373	Ø 28	1	5

**DEAERATOR-DIRT SEPARATOR WITH MAGNET**



**5464 DISCAL DIRTMAG**

Deaerator-dirt separator **with magnet**. Technopolymer body. **Female connections. Adjustable for horizontal and vertical pipes.** With hygroscopic safety cap. Drain cock with hose connection. Max. working pressure: 3 bar. Temperature range: 0–90 °C.

PCT INTERNATIONAL APPLICATION PENDING

**Threaded connections**

Code			
546405	3/4" F	1	5
546406	1" F	1	5
546407	1 1/4" F	1	5

**Compression ends**

Code			
546402	Ø 22	1	5
546403	Ø 28	1	5

**INSTRUMENT HOLDER IN TECHNOPOLYMER MATERIAL**

**305**

Instrument holder in technopolymer material for heating systems. Equipped with air vent, safety relief valve in technopolymer material and pressure gauge. **With insulation.** Temperature range: 5–90 °C. Up to 50 kW.



Code			
305663	1" 3 bar TÜV	1	5

**305**

Instrument holder in technopolymer material for heating systems. Equipped with air vent in technopolymer material, safety relief valve and pressure gauge. **With insulation.** Temperature range: 5–90 °C. Up to 50 kW.



Code			
305671	1" 1,8 bar	1	5
305673	1" 3 bar NF	1	5
305674	1" 4 bar without insulation	1	5

**305**

Instrument holder kit in technopolymer material for heating systems. Equipped with air vent, safety relief valve in technopolymer material, pressure gauge, automatic shut-off cock for expansion vessel and fixing bracket. **With insulation.** Temperature range: 5–90 °C. Up to 50 kW.



Code			
305503	3/4" 3 bar TÜV	1	10

DIFFERENTIAL BY-PASS VALVE



519

tech. broch. 01007

Differential by-pass valve, adjustable with graduated scale. Max. working pressure: 10 bar. Temperature range: 0–110 °C. Max. percentage of glycol: 30 %.



Threaded connections

Code		Setting range m w.g.		
519500	3/4"	1–6	1	50
519504	3/4"	10–40	1	50
519700	1 1/4"	1–6	1	10
519703	1 1/4"	5–25	1	10

Compression ends

Code		Setting range m w.g.		
519002	Ø 22	1–6	1	50



518

tech. broch. 01007

Differential by-pass valve, adjustable with graduated scale. Max. working pressure: 10 bar. Temperature range: 0–100 °C. Max. percentage of glycol: 30 %.

Code		Setting range m w.g.		
518015	3/4"	1–6	1	25



518

tech. broch. 01410

Differential by-pass valve, adjustable with graduated scale. Max. working pressure: 10 bar. Temperature range: 0–100 °C. Max. percentage of glycol: 30 %.

Threaded connections

Code		Setting range m w.g.		
518500	3/4"	1–6	1	50

Compression ends

Code		Setting range m w.g.		
518002	Ø 22	1–6	1	50

Application diagrams of differential by-pass valve

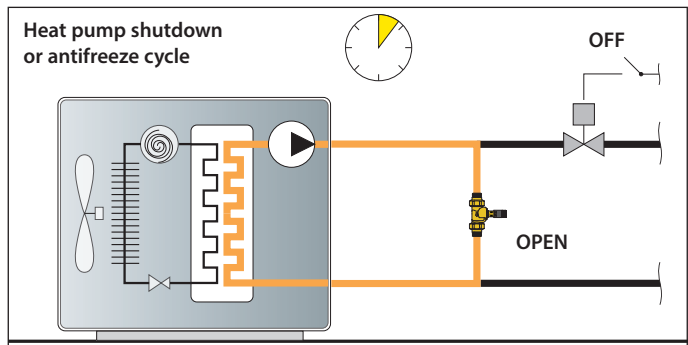
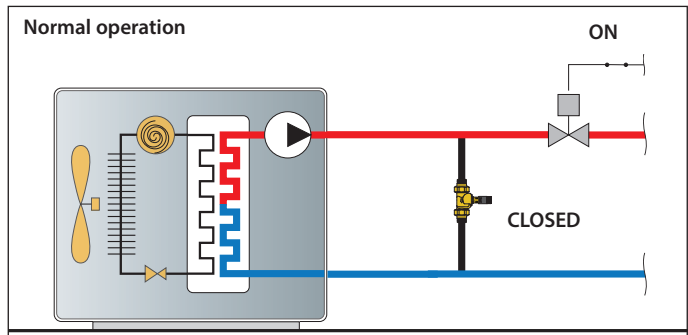

BALANCING VALVE WITH FLOW METER

132

tech. broch. 01149



Balancing valve with flow meter. Direct reading of flow rate. Brass valve body and flow meter. Ball valve for flow rate adjustment. Graduated scale flow meter with magnetic movement flow rate indicator.

With insulation.

Max. working pressure: 10 bar. Temperature range: -10–110 °C. Max. percentage of glycol: 50 %. PATENT PENDING.



Code		Flow rate range (l/min)		
132512	3/4"	5–13	1	5
132522	3/4"	7–28	1	5
132602	1"	10–40	1	5
132702	1 1/4"	20–70	1	5
132802	1 1/2"	30–120	1	5

Application diagram

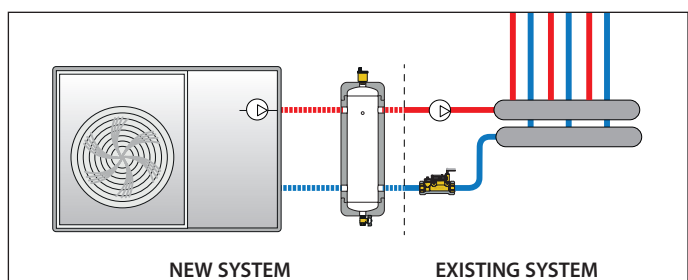

STAINLESS STEEL INERTIAL HYDRAULIC SEPARATOR FOR HEAT PUMP



5485

tech. broch. 01406

Wall-mounted inertial hydraulic separator for heat pump.  
 In AISI 304 **stainless steel**.  
 With highly effective expanded EPP insulation.  
 Max. working pressure: 4 bar.  
 Max. percentage of glycol: 30 %.  
 Working temperature range:  
 -10–95 °C (without the formation of ice).  
 Air vent top connection:  
 15–30 liters 1";  
 50 liters 1 1/4".

Drain valve bottom connection:  
 15–30 liters 1";  
 50 liters 1 1/4".

Front probe holder connection 1/4" F.

Construction details

Material AISI 304 stainless steel

The 5485 series inertial hydraulic separator is a higher quality product than traditional carbon steel types, and therefore helps to keep the thermal system clean. It therefore reduces the number of problems caused by the impurities generated by corrosion

EPP insulation

The highly effective expanded PPE insulation allows the heat pump to run efficiently in both heating and air-conditioning modes. The special boxy geometry makes the inertial hydraulic separator extremely compact and visually attractive.

Front probe holder connection

The 1/4" probe holder connection can be used to measure the thermal medium temperature with temperature probes or measurement temperature gauges.

Sizing

The hydraulic separator should be sized in accordance with the maximum recommended flow rate value at the inlet. The selected value should be the sum of the primary circuit flow rates or the sum of the secondary circuit flow rates, whichever is greater.

On the other hand, the inertial hydraulic separator volume depends on the minimum volume of water required by the heat pump manufacturer to guarantee proper machine operation even in defrosting phases. Generally, with more modern heat pumps, it can assume an average value calculated on the basis of the machine power, which varies from 2,5 to 3,5 litres/kWt.

Code	Volume	Connections		
548515	15 liters	1" F	1	-
548520	20 liters	1" F	1	-
548525	25 liters	1" F	1	-
548530	30 liters	1" F	1	-
548550	50 liters	1 1/4" F	1	-



5020 MINICAL®

tech. broch. 01406

Automatic air vent. In hot stamped brass. With hygroscopic safety cap.  
**With insulation.**  
 Max. working pressure: 10 bar.  
 Max. drain pressure: 2,5 bar.  
 Max. working temperature: 120 °C.



Code	Volume	Connections		
502067	1" M		1	50



Fitting for code 548550.

Code	Volume	Connections		
F0001878	1 1/4" M x 1" F		1	-

Volume	Connections	Max flow rate	Nominal power HP
15 l	1"	3,5 m <sup>3</sup> /h	3–5 kWt
20 l	1"	3,5 m <sup>3</sup> /h	
25 l	1"	3,5 m <sup>3</sup> /h	6–8 kWt
30 l	1"	3,5 m <sup>3</sup> /h	9–12 kWt
50 l	1 1/4"	5,5 m <sup>3</sup> /h	13–25 kWt

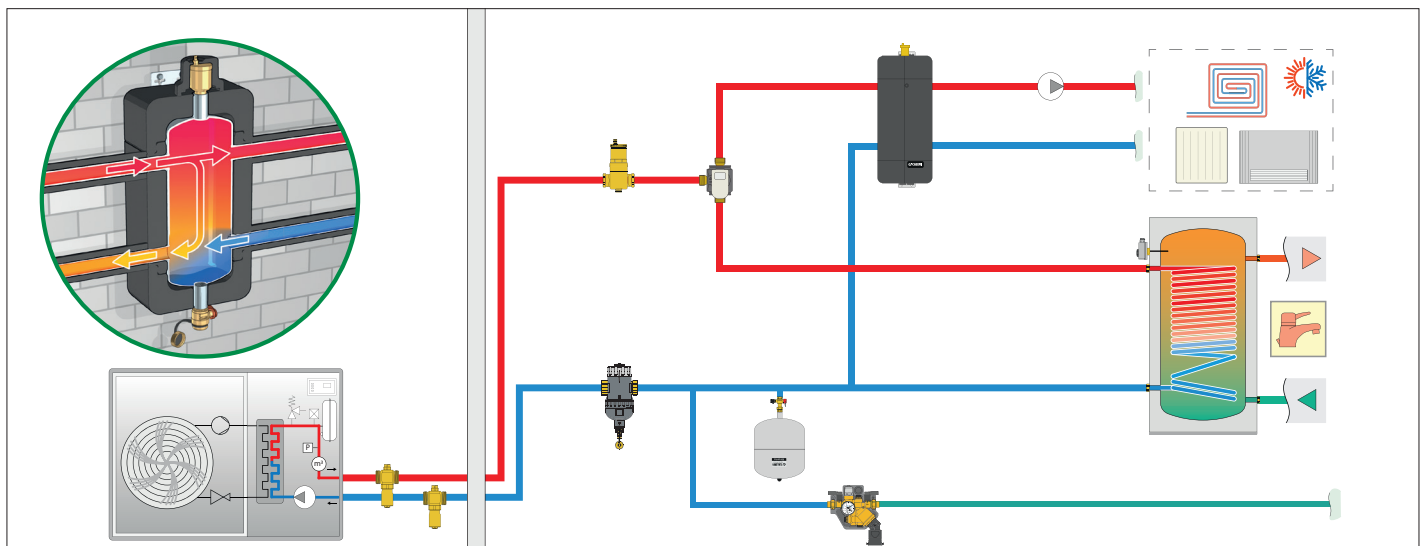

STAINLESS STEEL INERTIAL HYDRAULIC SEPARATOR FOR HYBRID SYSTEMS



**5485** **NEW**

tech. broch. 01380

Wall-mounted inertial hydraulic separator for hybrid systems.  
 In AISI 304 **stainless steel**.  
 With highly effective expanded EPP insulation.  
 Pmax di esercizio: 4 bar.  
 Max. percentage of glycol: 30 %.  
 Working temperature range:  
 -10-95 °C (without the formation of ice).

Connections: 1 1/4" F.  
 Front probe holder connection 1/4" F.

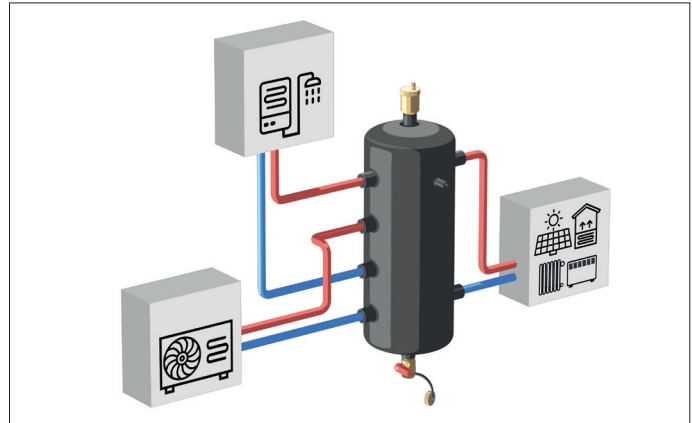

Code	Volume	Connections		
<b>548551</b>	50 litres	1 1/4" F	1	-



**5020**  
**MINICAL®**

tech. broch. 01406

Automatic air vent. In hot stamped brass.  
 With hygroscopic safety cap.  
**With insulation.**  
 Max. working pressure: 10 bar.  
 Max. drain pressure: 2,5 bar.  
 Max. working temperature: 120 °C.



Code	Volume	Connections		
<b>502067</b>	1" M		1	50



Fitting for code 548550.

Code	Volume	Connections		
<b>F0001878</b>	1 1/4" M x 1" F		1	-

Reg. UE N. 812/2013 All. IV.2.1

Code	Volume [litres]	Useful volume [litres]	Energy class [ErP]	Dispersion [W]
<b>548515</b>	15	15	A	16
<b>548520</b>	20	20	A	20
<b>548525</b>	25	25	A	22
<b>548530</b>	30	30	B	28
<b>548550</b>	50	49	A	27
<b>548551</b>	50	49	A	27

**Energy class**

The 5485 series is designed for high energy efficiency.

Low losses ensure the buffer tank-hydraulic separator is in the best energy efficiency classes.

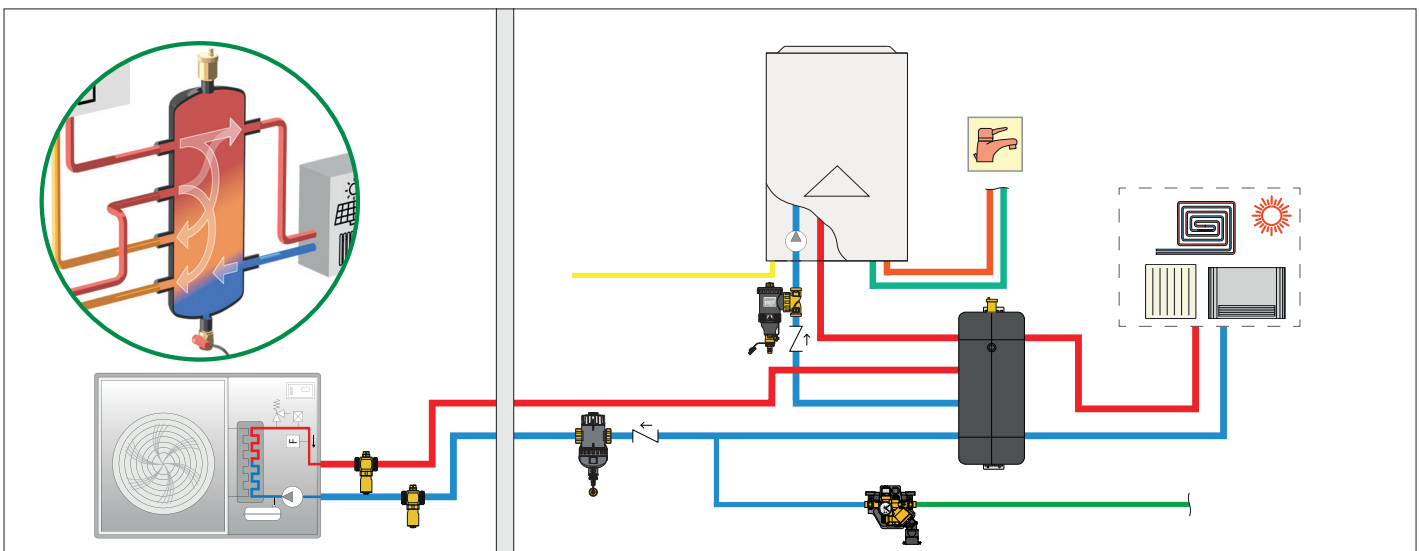
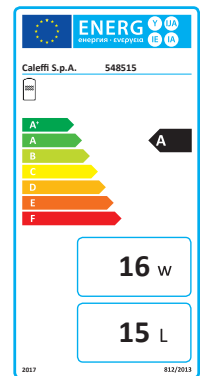

CHANGEOVER AND DISTRIBUTION UNIT FOR RADIANT PANEL/FAN-COIL SYSTEMS

NEW

664

tech. broch. 01417

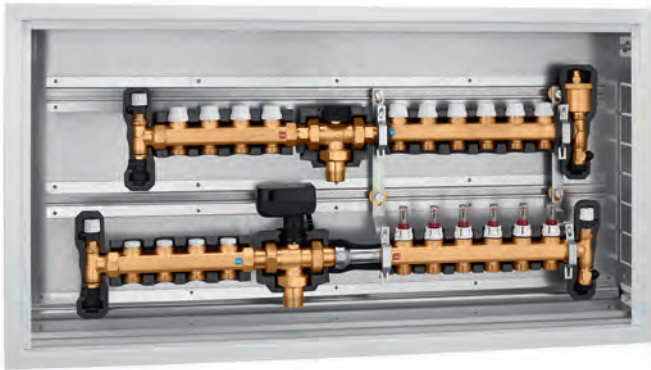

Changeover and distribution unit pre-assembled in box for radiant panel/ fan-coil systems.  
 Equipped with:  
 - distribution manifold for radiant panel systems with flow meters and shut-off valves, insulated,  
 - distribution manifold for fan-coil systems with lockshield valves for preset flow rate and shut-off valves, insulated,  
 - three-way diverter valve with three-point control, complete with insulation and anti-condensation spacer,  
 - check valve kit,  
 - box.  
 Max. working pressure: 6 bar.  
 Adjustment temperature range: 5–60 °C.  
 Supply: 230 V - 50/60 Hz.



Winter

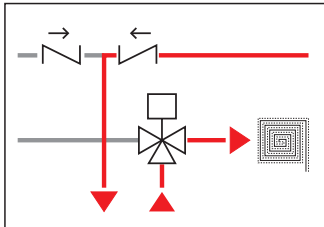

Summer

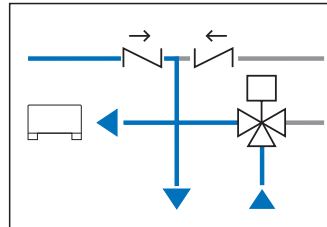

Code	Conn.	Outlet No. to panels	Outlet No. to fan-coil
6640F1	1" M	6 x 3/4" M	4 x 3/4" M
6640G1	1" M	7 x 3/4" M	4 x 3/4" M
6640H1	1" M	8 x 3/4" M	4 x 3/4" M
6640I1	1" M	9 x 3/4" M	4 x 3/4" M
6640L1	1" M	10 x 3/4" M	4 x 3/4" M
6640M1	1" M	11 x 3/4" M	4 x 3/4" M

Changeover and distribution unit dimensions for radiant panel/fan-coil systems

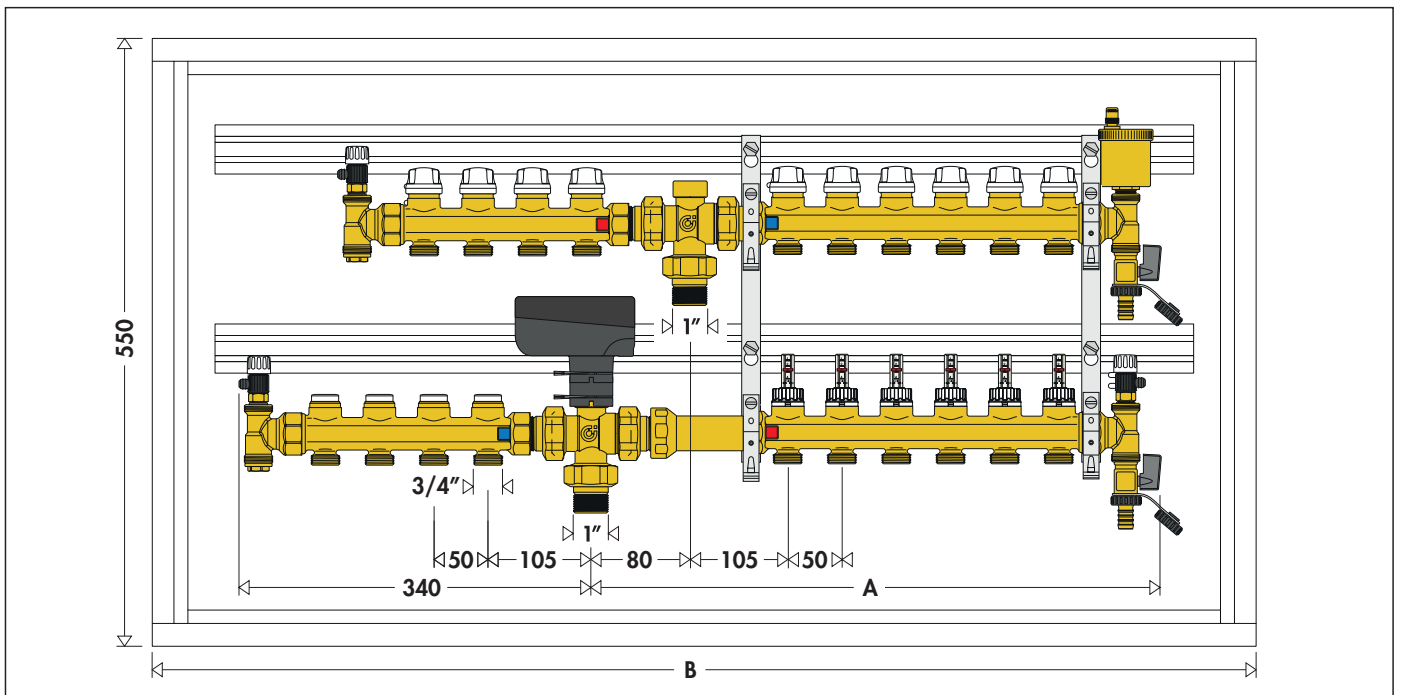

Outlet No.	4 + 6	4 + 7	4 + 8	4 + 9	4 + 10	4 + 11
A	520	570	620	670	720	770
B	1000	1000	1200	1200	1200	1200

## DEVICES FOR DIRT SEPARATION, AIR VENT, WATER TREATMENT

2

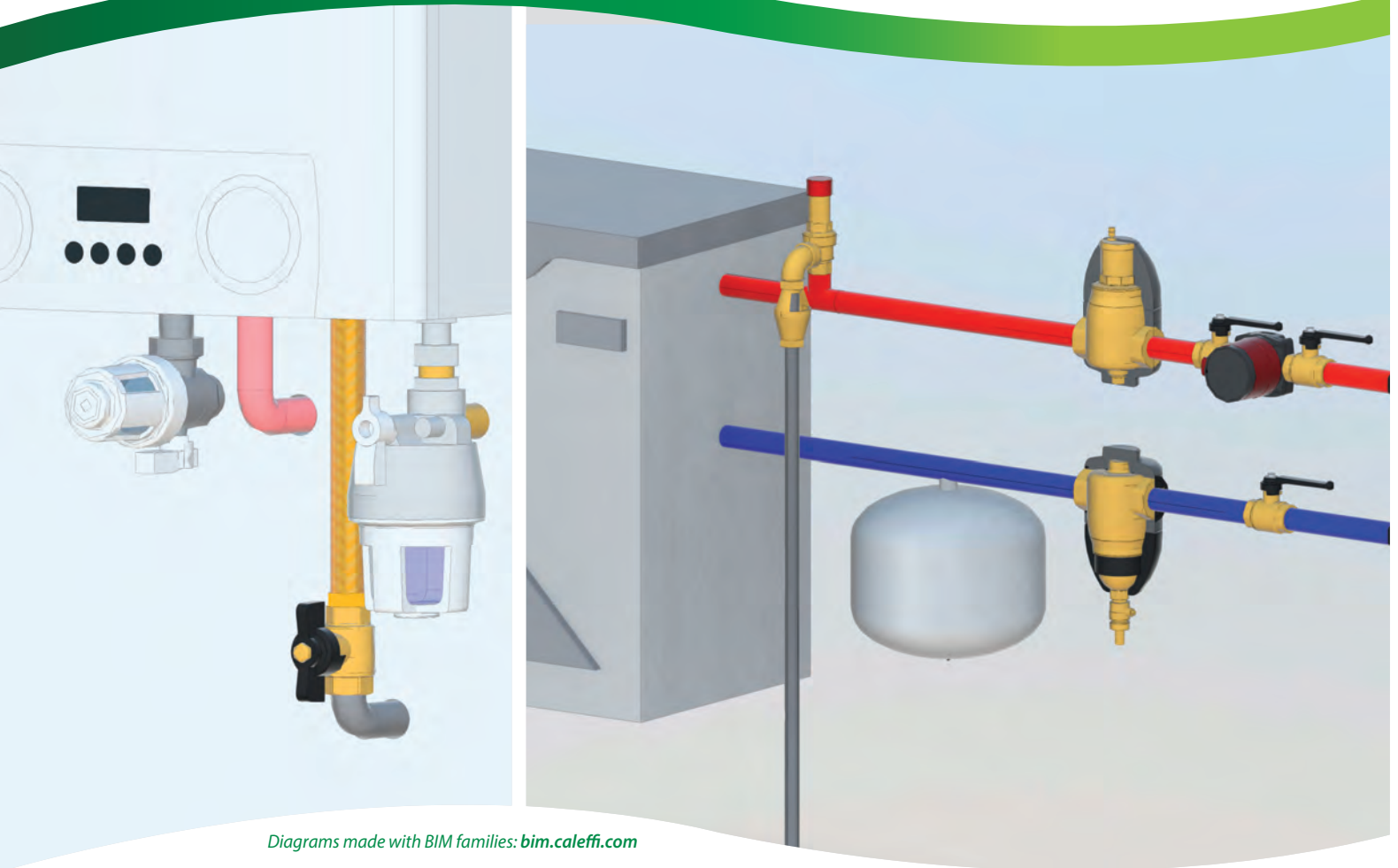

*Diagrams made with BIM families: [bim.caleffi.com](http://bim.caleffi.com)*

**Semi-automatic self-cleaning magnetic filter, CALEFFI XF**

**Multifunction device in technopolymer with dirt separator and strainer, DIRTMAGPLUS®**

**Under-boiler magnetic filter, CALEFFI XS®**

**Under-boiler dirt separators strainer with magnet, DIRTMAGMINI®**

**Dirt separators in technopolymer with magnet, DIRTMAG®**

**Dirt separators with magnet, DIRTMAG®**

**Dirt separators in technopolymer with double magnet for high flow rates, DIRTMAGPRO®**

**Self-cleaning dirt separator filter with magnet, DIRTMAGCLEAN®**

**Automatic air vent**

**End plug for radiators with automatic air vent**

**Manual air vents**

**High-efficiency Deaerators at air collection points**

**High-efficiency deaerator for heat pump systems, CALEFFI HED®**

**Drain cocks**

**Deaerators**

**Deaerator-dirt separator**

**Deaerator-dirt separator with magnet**

**Under-boiler polyphosphate dispenser, CALEFFI XP**

**Chemical additives**

**Automatic water treatment unit**

**Softening and demineralisation cartridges**

## AIR AND DIRT IN HEATING AND COOLING SYSTEMS

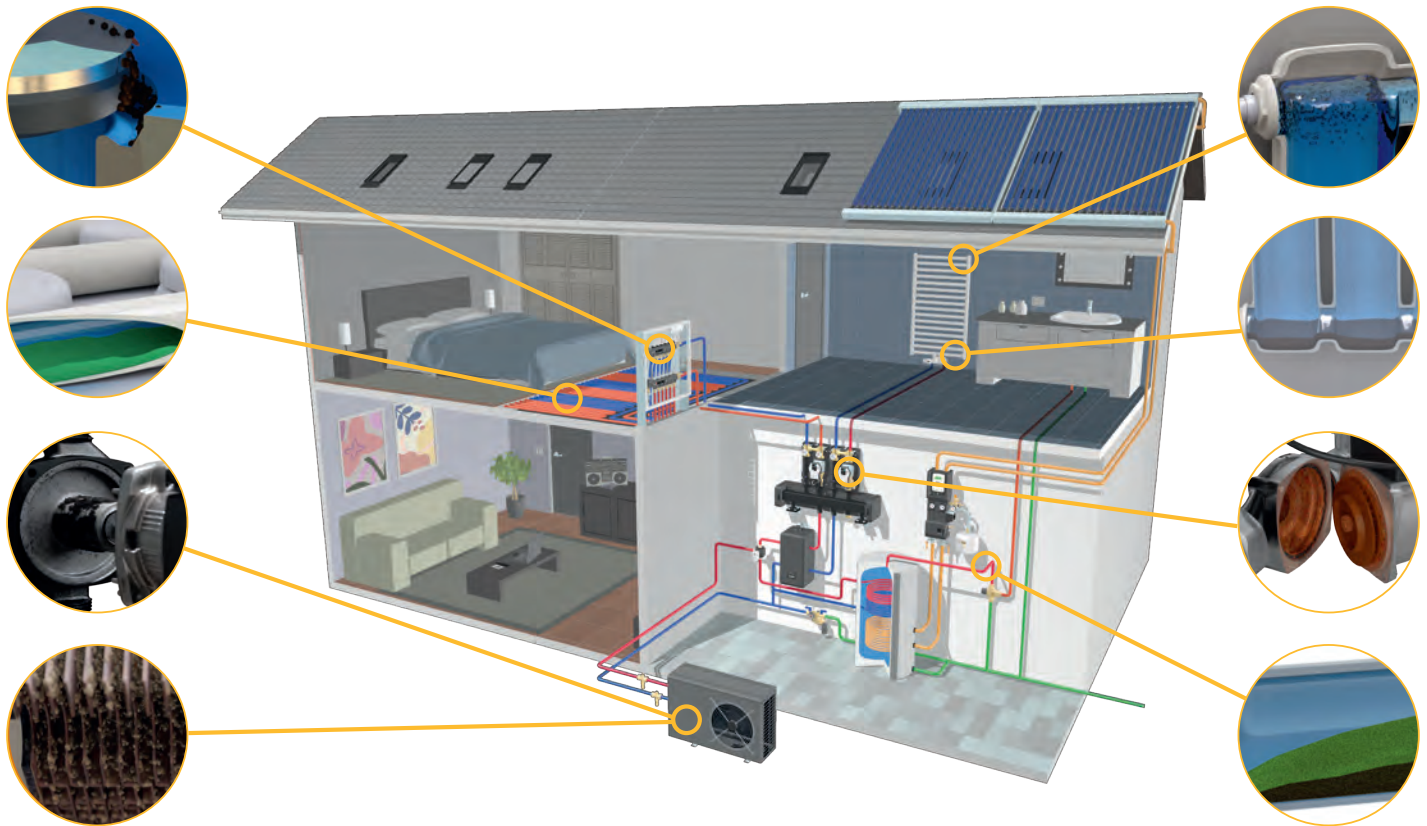

### Problems linked to the presence of dirt

The impurities contained in the water of the hydronic circuits can cause a series of problems that should not be underestimated.

#### Corrosion due to differential aeration

This is due to the fact that, in the presence of water, a layer of scale on a metal surface leads to the formation of two zones (water/impurities and impurities/metal) with a different oxygen content; for this reason, localised batteries are activated with current flows that lead to corrosion of the metal surfaces.

#### Irregular operation of the valves

This is due to impurities, which can adhere stubbornly to the valve seats and cause deformities in regulation and leaks, for example in balancing valves.

#### Pumps blocking and seizing

These problems may be suspended particles circulating through the pumps which can build up inside them, due to both the particular geometry of the pumps and to the effect of the magnetic fields generated by the pumps themselves.

#### Lower efficiency of the heat exchangers

Deposits and scale build-up can significantly reduce both the flow rates of the fluids and the heat exchanging surfaces.

### Problems linked to the presence of air

The problems caused by air contained in hydronic systems can be serious and unpleasant both for the users and for the professionals who service the system. If these problems are not analysed thoroughly, they can often lead to solutions that are not decisive in the long term. Initially it is very important to identify the phenomena that the air in the system can provoke.

#### Noise in the pipes and in the terminals

The air contained in the system makes noise in the pipes and the adjustment devices. This is much more evident during system startup, i.e. when the flow begins to flow through the pipes.

#### Insufficient flow rates, complete circulation blockages and insufficient heat exchange between the emission terminals and the room

Circulation can be partially or totally blocked by air bubbles present in some points in the system. This phenomenon is particularly serious for radiant panel systems, but can also cause thermal imbalances and lower radiator or fan coil efficiency.

#### Corrosion of the system

This is provoked by the oxygen present in the air and can lead to the weakening but also the breakage of components such as pipes, radiators and boiler heat exchangers.



#### Cavitation

This may compromise durability and operation, especially of the pumps and regulating valves.





**HEAT PUMP SYSTEMS**



**TECHNOPOLYMER MAGNETIC FILTERS DIRT SEPARATORS**

<i>SEMI-AUTOMATIC SELF-CLEANING</i>		<i>MANUAL CLEANING</i>	
	<p><b>CALEFFI XF 577</b></p> <p>3/4" – 2" Ø22 - Ø28</p>		<p><b>DIRTMAGPLUS® 5453</b></p> <p>3/4" – 1 1/4" Ø22 - Ø28</p>

**WALL-MOUNTED BOILER SYSTEMS**

<i>MAGNETIC FILTER</i>		<i>DIRT SEPARATOR IN TECHNOPOLYMER WITH MAGNET AND FILTER</i>	
<i>ANGLED INSTALLATION</i>	<i>IN-LINE INSTALLATION</i>	<i>UNIVERSAL INSTALLATION</i>	
	<p><b>CALEFFI XS® 5459</b></p> <p>3/4" M x 3/4" F captive nut Ø22</p>		<p><b>DIRTMAGMINI® 5450</b></p> <p>3/4" F captive nut x 3/4" M Ø22</p>



**WALL-MOUNTED BOILER SYSTEMS WITH TECHNICAL ROOM - COOLING SYSTEMS**

<i>TECHNOPOLYMER DIRT SEPARATOR WITH MAGNET</i>	<i>TECHNOPOLYMER DIRT SEPARATOR WITH DOUBLE MAGNET</i>	<i>TECHNOPOLYMER MAGNETIC FILTER DIRT SEPARATOR</i>			
<i>STANDARD FLOW RATES</i>	<i>HIGH FLOW RATES</i>	<i>SEMI-AUTOMATIC CLEANING</i>			
			<p><b>DIRTMAG® 5453</b></p> <p>3/4" – 1" – 1 1/4" Ø22 - Ø28</p>	<p><b>DIRTMAGPRO® 5457</b></p> <p>3/4" – 1 1/4" Ø22 - Ø28</p>	<p><b>CALEFFI XF 577</b></p> <p>3/4" – 1 1/4" Ø22 - Ø28</p>

**MEDIUM/LARGE SYSTEMS**

<i>TECHNOPOLYMER MAGNETIC FILTER DIRT SEPARATOR</i>	<i>BRASS DIRT SEPARATOR WITH MAGNET</i>	<i>STEEL DIRT SEPARATOR WITH MAGNET</i>			
			<p><b>CALEFFI XF 577</b></p> <p>1 1/2" – 2"</p>	<p><b>DIRTMAG® 5463</b></p> <p>3/4" – 2"</p>	<p><b>DIRTMAG® 5466</b></p> <p>DN 50–DN 65</p>

**LARGE SYSTEMS**

<i>DIRT SEPARATOR IN STEEL WITH MAGNET</i>	<i>SELF-CLEANING DIRT SEPARATOR FILTER WITH MAGNET</i>		
<i>IN-LINE INSTALLATION</i>	<i>BY-PASS INSTALLATION</i>		
		<p><b>DIRTMAG® 5466</b></p> <p>DN 50–DN 300</p>	<p><b>DIRTMAG CLEAN® 5790</b></p>

**SEMI-AUTOMATIC SELF-CLEANING MAGNETIC FILTER**

**577  
CALEFFI XF**

tech. broch. 01391



Semi-automatic self-cleaning magnetic filter.  
Technopolymer body.  
**Female connections.**  
**Adjustable for horizontal and vertical pipes.**  
Drain cock with hose connection.  
Max. working pressure: 3 bar.  
Temperature range: 0–90 °C.  
Mesh sized  $\varnothing = 0,16$  mm.



**577  
CALEFFI XF**

tech. broch. 01391



Semi-automatic self-cleaning magnetic filter **complete with by-pass.**  
Technopolymer body.  
**Female connections.**  
**Adjustable for horizontal and vertical pipes.**  
Drain cock with hose connection.  
Max. working pressure: 3 bar.  
Temperature range: 0–90 °C.  
Mesh sized  $\varnothing = 0,16$  mm.



**Threaded connections**

Code			
<b>577500</b>	3/4"	1	-
<b>577600</b>	1"	1	-
<b>577700</b>	1 1/4"	1	-

**Compression ends**

Code			
<b>577200</b>	$\varnothing 22$	1	-
<b>577300</b>	$\varnothing 28$	1	-

Code			
<b>577800</b>	1 1/2"	1	-
<b>577900</b>	2"	1	-

**Adjustable by-pass**

Sizes DN 40 (code 577800, 1 1/2") and DN 50 (code 577900, 2") are equipped with a by-pass that allows the limitation of the flow rate passing through the device by up to 50%, thereby increasing the Kv value. We recommend 100% filtration during filling and for the first weeks of system operation. Then, during the "maintenance" phase, the device can be set to function as a by-pass to achieve a higher Kv.



Insulation for semi-automatic self-cleaning magnetic filter.

Code	Use		
<b>CBN577500</b>	577500/600/700	1	-
<b>CBN577800</b>	577800/900	1	-

**Cleaning the filter mesh**

To clean the CALEFFI XF filter with the circulator stationary, there is no need to disassemble the component because it contains a mechanism with brushes to clean the filter mesh.

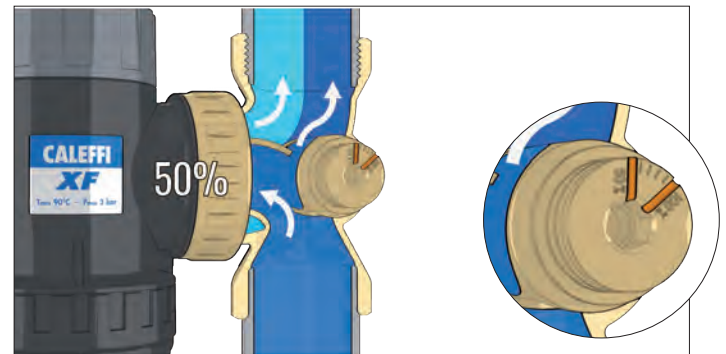
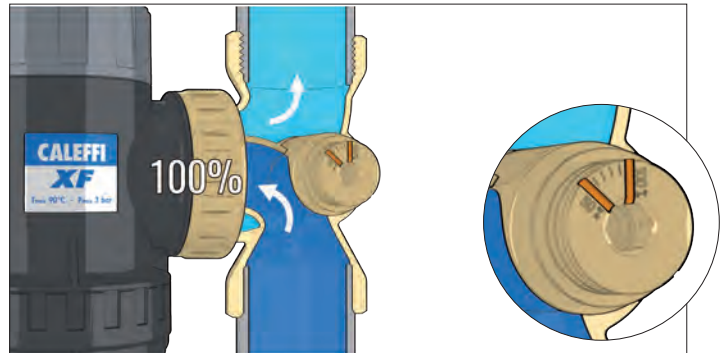
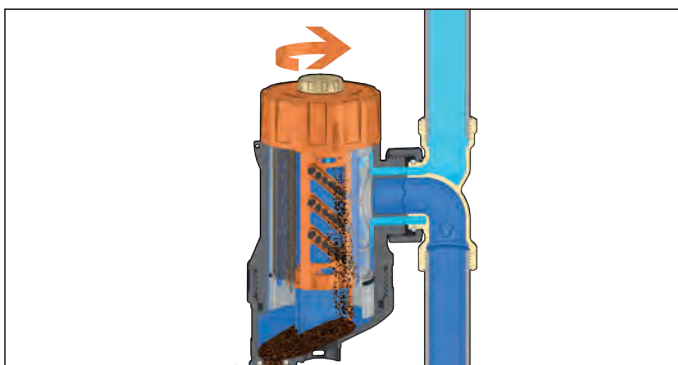

MULTIFUNCTION DEVICE IN TECHNOPOLYMER WITH DIRT SEPARATOR AND STRAINER



PCT INTERNATIONAL APPLICATION PENDING

5453

DIRTMAGPLUS®

tech. broch. 01258

Multifunction device with dirt separator and strainer. Specific for the complete cleaning of the hydraulic circuit, to protect continuously generator and components.

Technopolymer body.

Dirt separator with tecnopolimer internal element, **with magnet.**

Two inspectable strainers with stainless steel mesh: 1 for initial cleaning (blue colour) already installed, 1 for maintenance (grey colour) in package.

Shut-off valves with nuts, brass body.

**Female connections and Ø 22 and Ø 28 mm with compression ends.**

**Adjustable for horizontal, vertical or 45° pipes.**

Drain cock with hose connection.

Max. working pressure: 3 bar.

Temperature range: 0–90 °C.

Operating principle

The multifunction device is obtained by coupling a dirt separator and a cartridge strainer arranged in series.

The water circulating in the system flows, in sequence, first through the dirt separator and then through the cartridge strainer.

The dirt separator separates the impurities contained in the water by means of the action of the internal element.

Ferrous impurities are also trapped inside the body of the device thanks to the action of the two magnets inserted in a special removable outer ring.

The first passage through the dirt separator makes it possible to separate a high percentage of the impurities in the circulating water, down to minimal particle sizes. The cartridge strainer separates impurities by means of mechanical selection of the particles in accordance with their size, by means of a special metal mesh.

All the particles with diameter bigger than the mesh size are automatically stopped and separated, **with maximum separation efficiency at the first passage.**

Threaded connections

Code			
545375	3/4"	1	5
545376	1"	1	5
545377	1 1/4"	1	5

Compression ends

Code			
545372	Ø 22	1	5
545373	Ø 28	1	5



Code			
F49476	accessory kit	1	10
F49474/BL	first cleaning strainer (blue colour)	1	10
F49474/GR	maintenance strainer (grey colour)	1	10

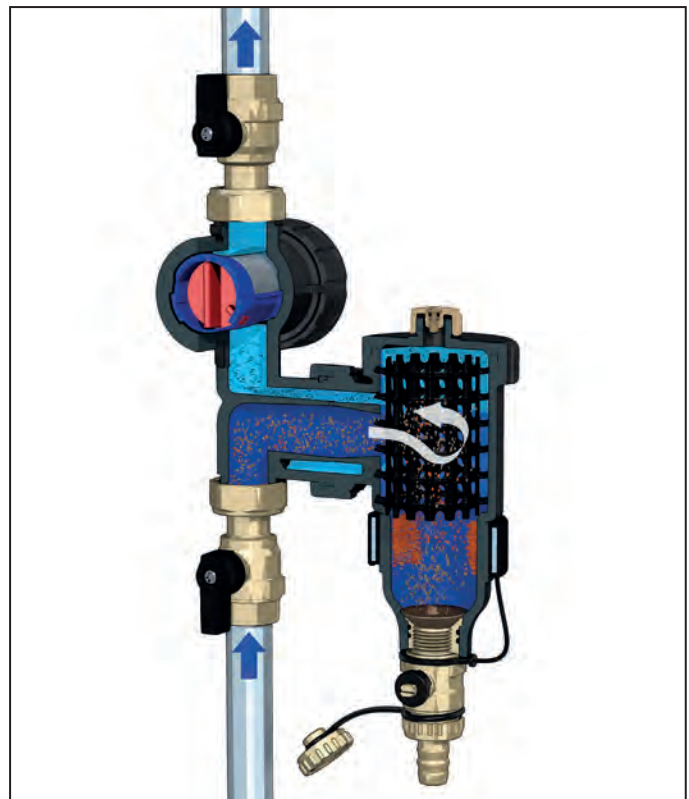

UNDER-BOILER MAGNETIC FILTER



5459

tech. broch. 01357

CALEFFI XS®

Under-boiler magnetic filter. Brass body. Chrome plated. Connections: 3/4" M x 3/4" F. Max. working pressure: 3 bar. Temperature range: 0-90 °C. PATENT PENDING.

Installation on the heating circuit

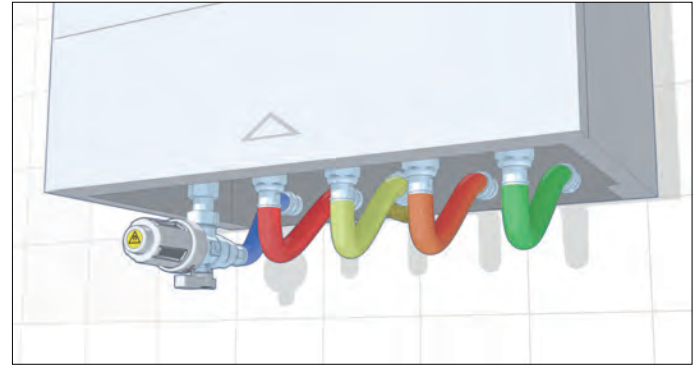

Code

545900 3/4" M x 3/4" F captive nut



1 10



Connection fitting with nut and gasket. Chrome plated.

Code

F0001297 3/4" F x 3/4" F



1 -



Flushing kit and additives addition.

Code

F0001037



1 -

Operating principle

The under-boiler magnetic filter mechanically separates the impurities in heating systems using a triple effect: a steel mesh strainer (mesh size Ø 0,80 mm) for light non-ferrous particles, a powerful neodymium magnet for the ferrous components, and a large calming chamber to collect the heavier particles. The chamber has transparent windows, allowing the user to check whether the internal elements need to be cleaned.

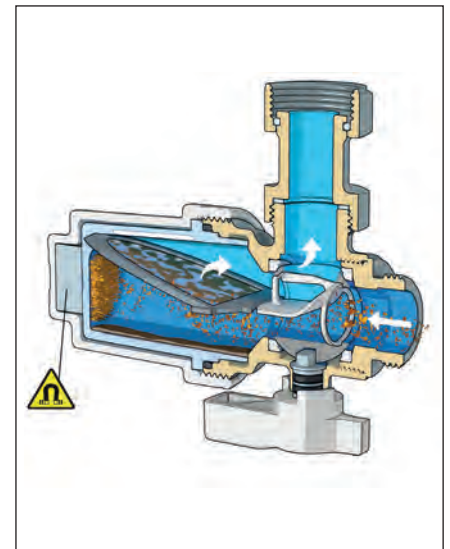

Maintenance

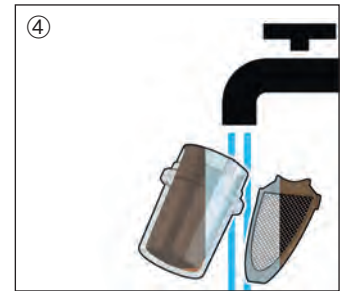
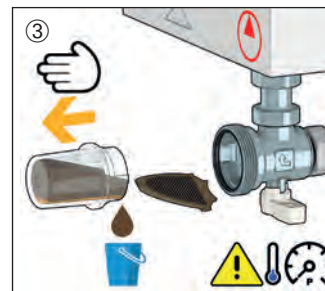
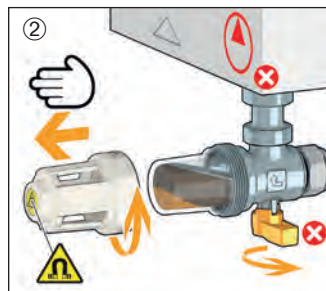
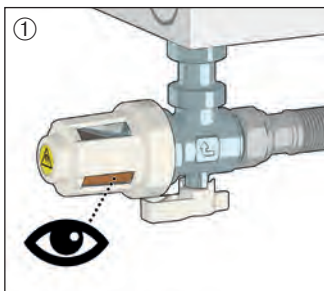

Protection pack

- Under-boiler magnetic filter;
- C3 FAST CLEANER;
- C1 FAST INHIBITOR.

To be used with kit code F0001037



Code

KIT545900



1 -

**UNDER-BOILER MAGNETIC FILTER**



**5459 CALEFFI XS®**

tech. broch. 01357

Under-boiler magnetic filter.  
Brass body. Chrome plated.  
In-line installation.  
Max. working pressure: 3 bar.  
Temperature range: 0-90 °C.  
PATENT PENDING.

Code			
<b>545910</b>	3/4" M x 3/4" F captive nut	1	10



Connection fitting with nut and gasket.  
Chrome plated.

Code			
<b>F0001297</b>	3/4" F x 3/4" F	1	-



Flushing kit and additives addition.

Code			
<b>F0001037</b>		1	-

**Installation on the heating circuit**

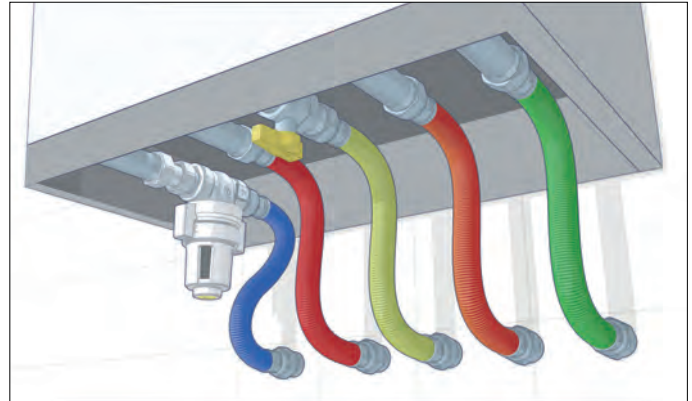

**Operating principle**

The under-boiler magnetic filter mechanically separates the impurities in heating systems using a triple effect: a steel mesh strainer (mesh size Ø 0,80 mm) for light non-ferrous particles, a powerful neodymium magnet for the ferrous components, and a large calming chamber to collect the heavier particles. The chamber has transparent windows, allowing the user to check whether the internal elements need to be cleaned.

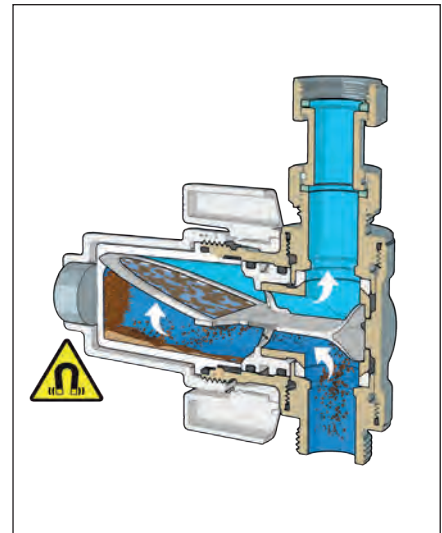

UNDER-BOILER DIRT SEPARATOR STRAINER WITH MAGNET



5450

tech. broch. 01348

DIRTMAGMINI®

Under-boiler dirt separator strainer with magnet.  
 Technopolymer body.  
 Drain cock with hose connection, chrome plated.  
 Boiler side connection: 3/4" F with captive nut.  
 System return side connection: 3/4" M.  
 Max. working pressure: 3 bar.  
 Temperature range: 0-90 °C.  
 PATENT PENDING.

Code

545000 3/4" F captive nut x 3/4" M



1 5

Operating principle

DIRTMAGMINI® magnetic dirt separator filter separates and captures impurities in the system thanks to the combined action of the strainer and dirt separator.

Ferrous impurities are also captured inside the body, thanks to the action of a removable magnet. Opening a dedicated cock drains the captured impurities.

The medium from the system is slowed down, so that the smaller particles that are not stopped by the filter separate and deposit, and are thereby removed from circulation. The special profile of the bottom allows the impurities to be captured and drained effectively.

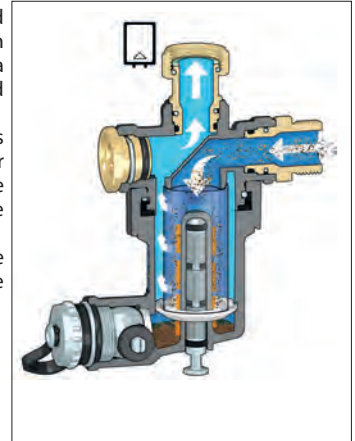

5450

tech. broch. 01348

DIRTMAGMINI®

Under-boiler dirt separator strainer with magnet and shut-off valves.  
 Technopolymer body.  
 Drain cock with hose connection.  
 Connections: Ø 22 mm.  
 Max. working pressure: 3 bar.  
 Temperature range: 0-90 °C.  
 PATENT PENDING.



Code

545022 Ø 22



1 5

Filtration, dirt separation and self-cleaning

The high performance of the dirt separator is based on the combined action of the filter and dirt separation function. With its mesh size of 800 µm, the filter mesh can capture non-magnetic residues such as sand, soldering residues and residues of sealants such as hemp or PTFE. The magnet, which is not in direct contact with the medium, separates and captures magnetic particles. It is possible to drain the impurities without disassembling the body, just by removing the magnet and opening the dedicated cock. Only perform this operation when the system is not in operation.

A self-cleaning function activates during draining, using the same system water (which is then collected in a dedicated container and disposed of in accordance with the regulations in force) to clean the filter. For this reason, there is normally no need to open the filter body to clean it manually, although this may be required during extraordinary maintenance.

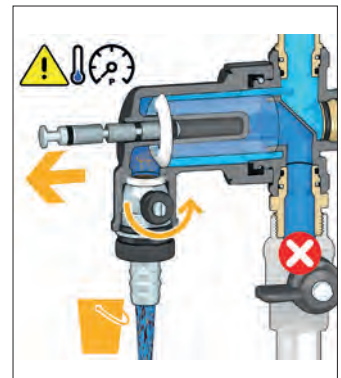

Installation

The magnetic dirt separator filter should be installed in the return circuit to protect the boiler from all the impurities in the system, especially during the start-up phase. It may be installed either vertically or horizontally, with the drain cock always in a suitable position, in accordance with the flow direction indicated by the arrows on the valve body.

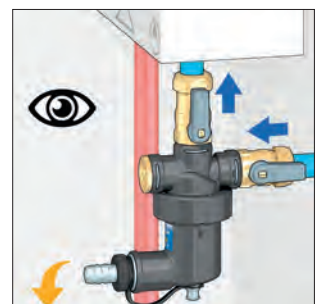
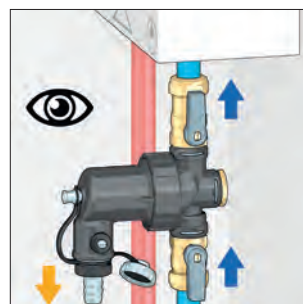
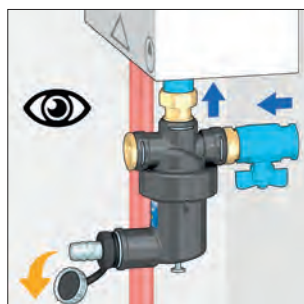
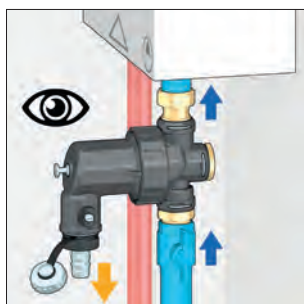

DIRT SEPARATOR IN TECHNOPOLYMER WITH MAGNET



**5453 DIRTMAG®**

tech. broch. 01240

Dirt separator **with magnet**.  
Technopolymer body.  
**Female connections and Ø 22 and Ø 28 mm with compression ends.**  
**Adjustable for horizontal and vertical pipes.**  
Drain cock with hose connection.  
Max. working pressure: 3 bar.  
Temperature range: 0–90 °C.



Threaded connections

Code		Max recommended flow rate [m³/h]		
545305	3/4"	1,3	1	5
545306	1"	1,3	1	5
545307	1 1/4"	2,1	1	5

Compression ends

Code			
545302	Ø 22	1	5
545303	Ø 28	1	5



**5453 DIRTMAG®**

tech. broch. 01240

Dirt separator **with magnet**.  
Technopolymer body.  
**Female connections and Ø 22 and Ø 28 mm with compression ends.**  
**Adjustable for horizontal and vertical pipes.**  
Drain cock with hose connection.  
Max. working pressure: 3 bar.  
Temperature range: 0–90 °C.  
**With insulation.**



545325	3/4"	1,3	1	5
545326	1"	1,3	1	5



Insulation for dirt separators 5453 series.

Code	Use		
CBN545305	545305/306	1	-



**5453 DIRTMAG®**

tech. broch. 01240

Dirt separator with **shut-off valves and magnet**.  
Technopolymer body.  
**Female connections.**  
**Adjustable for horizontal, vertical or 45° pipes.**  
Drain cock with hose connection.  
Max. working pressure: 3 bar.  
Temperature range: 0–90 °C.



Code		Max recommended flow rate [m³/h]		
545345	3/4"	1,3	1	5
545346	1"	1,3	1	5
545347	1 1/4"	2,1	1	5



Insulation for dirt separators 5453 series.

Code	Use		
CBN545345	545345/346/347	1	-



**Protection pack**

Package consisting of:  
- dirt separator with **shut-off valves and magnet**;  
- C3 CLEANER;  
- C1 INHIBITOR.

Threaded connections

Code			
KIT545345	with dirt separator 3/4"	1	-
KIT545346	with dirt separator 1"	1	-

Compression ends

Code	Conn.		
KIT545342	with dirt separator Ø 22	1	-

**DIRT SEPARATOR WITH DOUBLE MAGNET FOR HIGH FLOW RATES**



**5457**

tech. broch. 01388

**DIRTMAGPRO®**

Dirt separator with double magnet  
 For high flow rates.  
 Technopolymer body.  
 Female connections.  
 Adjustable for horizontal and vertical pipes.  
 Drain cock with hose connection.  
 Max. working pressure: 3 bar.  
 Temperature range: 0–90 °C.



Insulation for dirt separators 5457 series.

Code	Use		
<b>CBN545305</b>	545705-545706-545702-545703	1	–

**Threaded connections**

Code		Max recommended flow rate [m³/h]		
<b>545705</b>	3/4"	1,6	1	5
<b>545706</b>	1"	1,8	1	5
<b>545707</b>	1 1/4"	2,6	1	5

**Compression ends**

Code		Max recommended flow rate [m³/h]		
<b>545702</b>	Ø 22	1,6	1	5
<b>545703</b>	Ø 28	1,8	1	5

**Operating principle**

The impurities circulating within the closed circuits of systems, consisting of some sand and dirt particles but mostly ferrous material such as magnetite, are collected in a large collection chamber that does not require frequent cleaning.

The ferrous impurities are captured by the removable magnetic ring and the four magnets positioned in the centre of the flow. These magnets allow greater velocity of the medium, up to 1.6 m/s and, as a result, help to achieve a higher flow rate. Made using a technopolymer material specifically designed for use in air-conditioning systems, this dirt separator is especially versatile as it can be installed on both horizontal and vertical pipes.

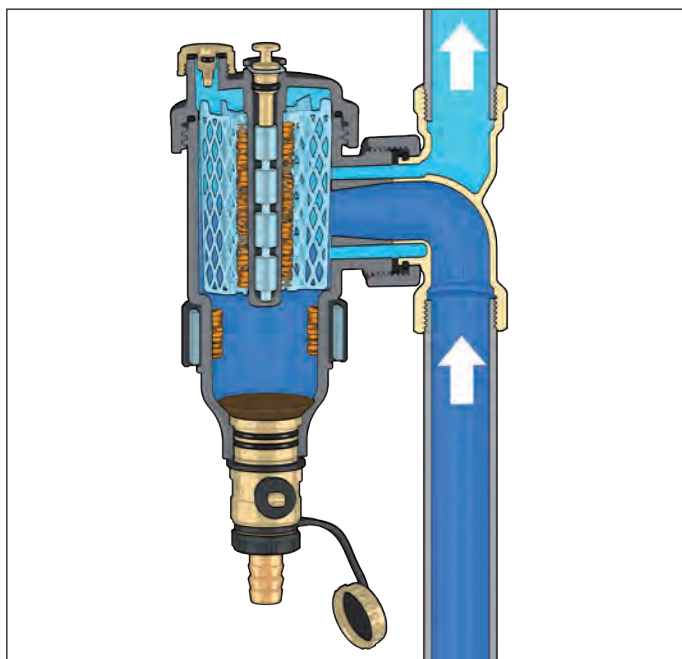

**Sludge drain**

Switch off the circulator, remove the stem holding the magnets from the top cover (1), remove the ring in which the magnets are housed (2) and drain the impurities, using the special key provided (3).

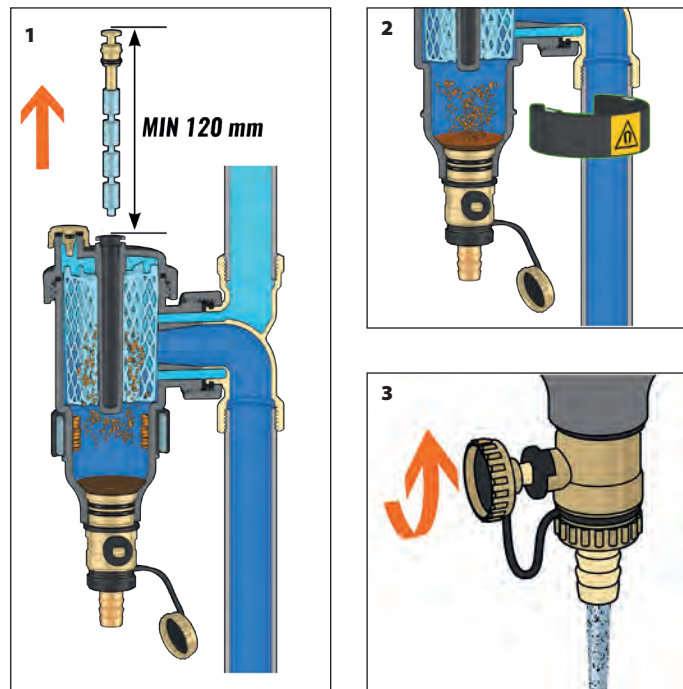



DIRT SEPARATORS WITH MAGNET



**5463**  
**DIRTMAG®**

tech. broch. 01137

Dirt separator **with magnet**.  
Brass body.  
**Female connections.**  
Drain cock with hose connection.  
Top connection with plug.  
**With insulation.**  
Max. working pressure: 10 bar.  
Temperature range: 0–110 °C.  
Particle separation rating down to 5 µm.



Code			
546315	3/4"	1	–
546316	1"	1	8
546317	1 1/4"	1	–
546318	1 1/2"	1	–
546319	2"	1	–



**5466**  
**DIRTMAG®**

tech. broch. 01137

Dirt separator **with magnet**.  
Epoxy resin coated steel body.  
**Flanged connections PN 16.**  
To be coupled with flat counterflanges EN 1092-1.  
**With insulation.**  
Max. working pressure: 10 bar.  
Temperature range: 0–100 °C.  
Particle separation rating down to 5 µm.



Code			
546650	DN 50	1	–
546660	DN 65	1	–
546680	DN 80	1	–
546610	DN 100	1	–
546612	DN 125	1	–
546615	DN 150	1	–



**5463**  
**DIRTMAG®**

depl. 01137

Dirt separator **with magnet**.  
Brass body.  
**Female connections.**  
Drain cock with hose connection.  
Top connection with plug.  
Max. working pressure: 10 bar.  
Temperature range: 0–110 °C.  
Particle separation rating down to 5 µm.



Code			
546305	3/4"	1	6
546306	1"	1	6
546307	1 1/4"	1	5
546308	1 1/2"	1	5
546309	2"	1	5



**5466**  
**DIRTMAG®**

tech. broch. 01137

Dirt separator **with magnet**.  
Epoxy resin coated steel body.  
**Flanged connections PN 10.**  
To be coupled with flat counterflanges EN 1092-1.  
Max. working pressure: 10 bar.  
Temperature range: 0–100 °C.  
Temperature probe connection: 1/2" F.  
Particle separation rating down to 5 µm.



Code			
546620	DN 200	1	–
546625	DN 250	1	–
546630	DN 300	1	–



Insulation  
for dirt separators 5462 and 5463 series.

Code	Use		
CBN546205	546205-546206-546305-546306	1	–
CBN546207	546207-546208-546307-546308	1	–
CBN546209	546209-546309	1	–

**Operating principle**

The magnetic dirt separator, in addition to the traditional dirt separation function, is equipped with a patented device to collect ferrous impurities contained within the system water. For the threaded version a specific ring, featuring two slots for housing the magnets, is placed outside the body in the part for collecting the impurities while, for the flanged version, the magnet is inserted in a specific pocket positioned inside the body, extractable for cleaning from magnetic dirt particles. The ferrous particles are trapped in this way in the collection zone, thus avoiding they return in circulation.

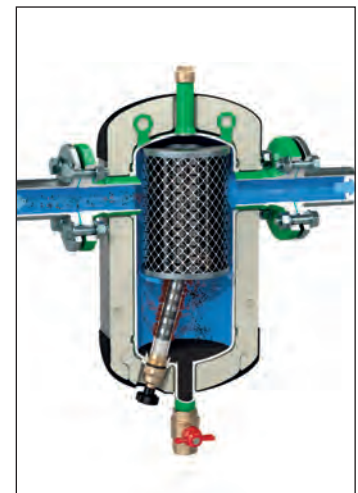

**SELF-CLEANING DIRT SEPARATOR  
FILTER WITH MAGNET**

**5790  
DIRTMAGCLEAN®**

tech. broch. 01358

Self-cleaning dirt separator filter with magnet.  
Body and support feet in stainless steel AISI 304.  
Connections: inlet 2" M with union,  
outlet 2" F,  
drain 1" M with union,  
flushing 1" F.  
Max working pressure: 10 bar.  
Temperature range: 5–85 °C.  
Supply: 230 V.  
Particle separation rating down to 2 µm.  
Fitted for inserting chemical additives.  
Fitted for MODBUS-RTU management.  
PATENT PENDING.

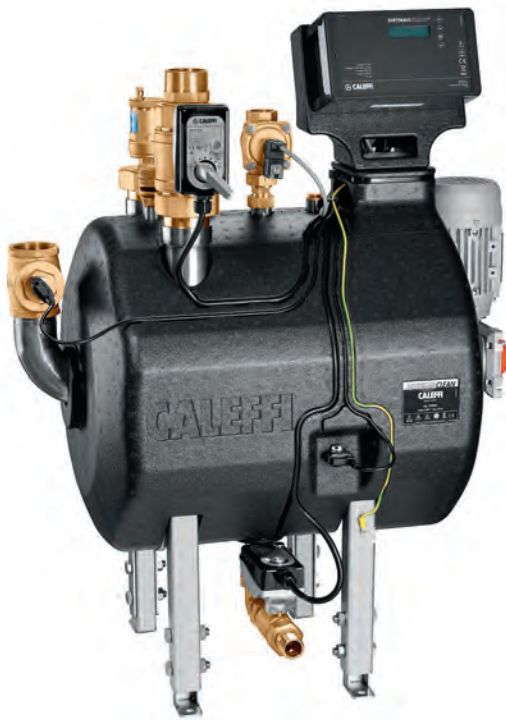

Code	Kv (m³/h)		
579000	45	1	-

**MANUAL CLEANING DIRT SEPARATOR  
FILTER WITH MAGNET**

**5790  
DIRTMAGCLEAN®**

tech. broch. 01358

Manual cleaning dirt separator filter with magnet.  
Body and support feet in stainless steel AISI 304.  
Connections: inlet 2" F,  
outlet 2" F,  
drain 1" M with union,  
flushing 1" F.  
Max working pressure: 10 bar.  
Temperature range: 5–85 °C.  
Particle separation rating down to 2 µm.  
PATENT PENDING.







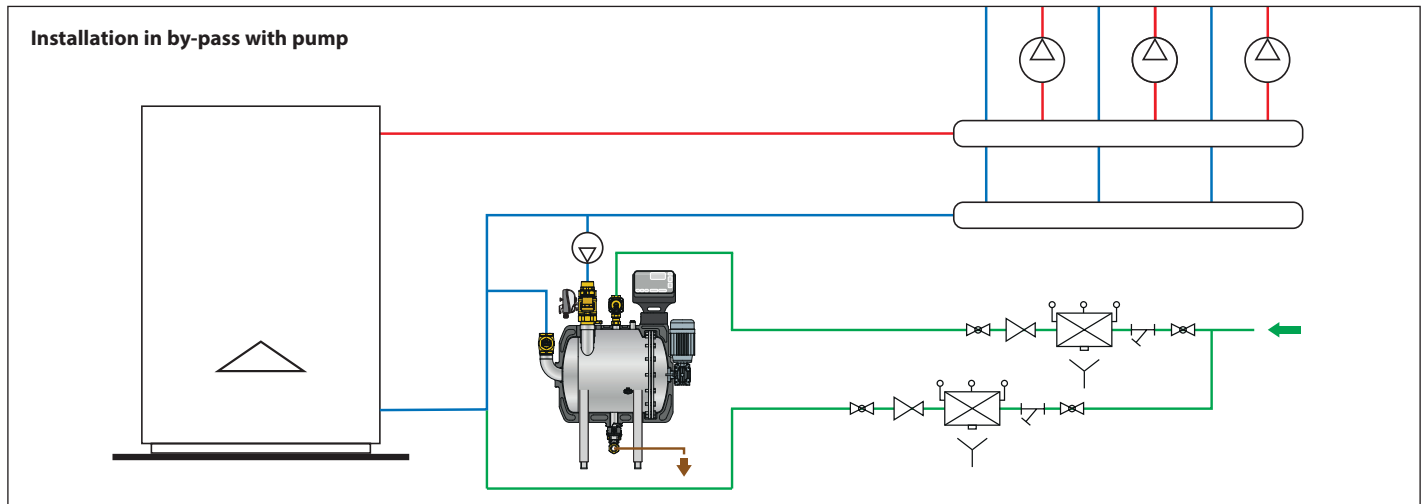







Code	Kv (m³/h)		
579001	45	1	-

**Application diagrams 579000/579001 code**



## Automatic air vents



Standard automatic air vents								
Code	502030/40	502031/41	502050/60	502051/61	502130/40	502131/41	502132/42	502133
	<b>MINICAL®</b>							
								
Material	brass	chrome plated brass	brass	chrome plated brass	brass	chrome plated brass	chrome plated brass	brass
Maximum working pressure	10 bar							
Maximum working temperature	120 °C				110 °C			
Automatic shut-off	optional		-		✓			
Hygroscopic cap	optional		✓		optional		✓	-
Anti-suction valve	optional		optional		optional		optional	✓
Connections	3/8" - 1/2"	3/8" - 1/2"	3/4" - 1"	3/4" - 1"	3/8" - 1/2"	3/8" - 1/2"	3/8" - 1/2"	3/8"

Compact automatic air vents				
Code	502420/30	502530/33/43	502630/40/41	502730
	<b>ROBOCAL®</b>			
				
Material	brass	brass	brass/chrome plated	brass
Maximum working pressure	10 bar			
Maximum working temperature	115 °C	110 °C	115 °C	110 °C
Automatic shut-off	optional	✓	optional	✓
Hygroscopic cap	-	-	-	-
Anti-suction valve	-	-	optional	optional
Connections	1/4" - 3/8"	3/8" - 1/2"	3/8" - 1/2"	3/8"

### Hygroscopic cap

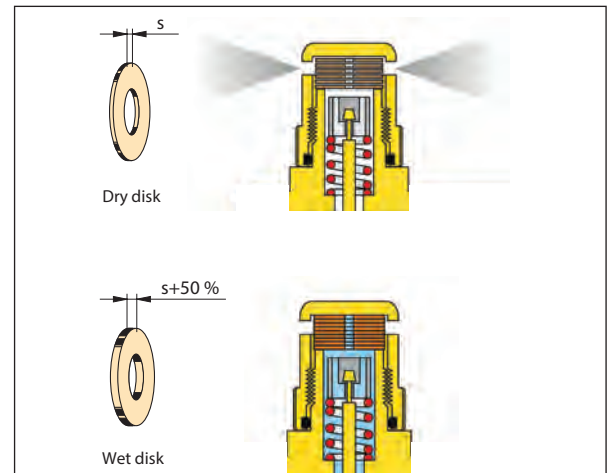
The discs increase in volume by 50 % when they come into contact with water. This leads to valve closure, in order to avoid potential leaks of water.



Automatic air vents with high discharge capacity			
Code	501500	551004	502221/31/41
	<b>MAXCAL®</b>	<b>DISCALAIR®</b>	<b>VALCAL®</b>
			
Material	brass	brass	chrome plated brass
Maximum working pressure	16 bar	10 bar	10 bar
Maximum working temperature	120 °C	110 °C	120 °C
Automatic shut-off	-	-	optional
Hygroscopic cap	-	optional	optional
Anti-suction valve	-	optional	optional
Connections	3/4"	1/2"	1/4"-3/8"-1/2"

### Automatic shut-off cock

This facilitates maintenance operations by inhibiting the flow of water when the valve is deactivated, and makes it easier to make sure the air vent device is working.

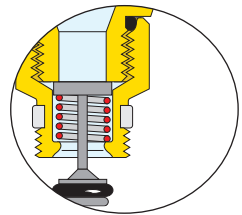

### Anti-suction valve

Installed on the air vent line, it functions as a check valve: it only allows air to be released.

In a situation where the system experiences negative pressure, the internal element closes off the outlet channel to prevent unwanted air from entering.

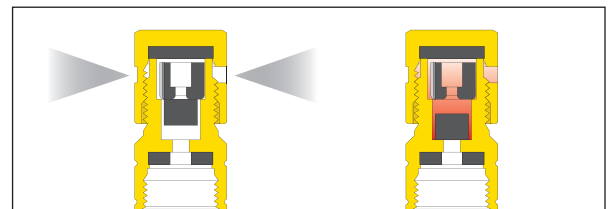

**AUTOMATIC AIR VENTS**

**STANDARD**



**5020  
MINICAL**

tech. broch. 01054

Automatic air vent.  
In hot-stamped brass.  
Max. working pressure: 10 bar.  
Max. discharge pressure: 2,5 bar.  
Max. working temperature: 120 °C.



Code

<b>502030</b>	3/8" M	10	50
<b>502040</b>	1/2" M	10	50



**5020  
MINICAL**

tech. broch. 01054

Automatic air vent.  
In hot-stamped brass.  
Chrome plated.  
Max. working pressure: 10 bar.  
Max. discharge pressure: 2,5 bar.  
Max. working temperature: 120 °C.



Code

<b>502031</b>	3/8" M	10	50
<b>502041</b>	1/2" M	10	50



**5020  
MINICAL**

tech. broch. 01054

Automatic air vent.  
In hot-stamped brass.  
With hygroscopic safety cap.  
Max. working pressure: 10 bar.  
Max. discharge pressure: 2,5 bar.  
Max. working temperature: 120 °C.



Code

<b>502050</b>	3/4" M	2	50
<b>502060</b>	1" M	2	50



**5020  
MINICAL**

tech. broch. 01054

Automatic air vent.  
In hot-stamped brass.  
Chrome plated.  
With hygroscopic safety cap.  
Max. working pressure: 10 bar.  
Max. discharge pressure: 2,5 bar.  
Max. working temperature: 120 °C.



Code

<b>502051</b>	3/4" M	2	50
<b>502061</b>	1" M	2	50



**5021  
MINICAL**

tech. broch. 01054

Automatic air vent.  
In hot-stamped brass.  
With automatic shut-off cock.  
Max. working pressure: 10 bar.  
Max. discharge pressure: 2,5 bar.  
Max. working temperature: 110 °C.



Code

<b>502130</b>	3/8" M	10	100
<b>502140</b>	1/2" M	10	100



**5021  
MINICAL**

tech. broch. 01054

Automatic air vent.  
In hot-stamped brass.  
Chrome plated.  
With automatic shut-off cock and  
hygroscopic safety cap.  
Max. working pressure: 10 bar.  
Max. discharge pressure: 2,5 bar.  
Max. working temperature: 110 °C.



Code

<b>502132</b>	3/8" M	10	100
<b>502142</b>	1/2" M	10	100



**5021  
MINICAL®**

tech. broch. 01054

Automatic air vent.  
With automatic shut-off cock  
and anti-vacuum cap.  
Max. working pressure: 10 bar.  
Max. discharge pressure: 2,5 bar.  
Max. working temperature: 110 °C.



Code

<b>502133</b>	3/8" M	1	10
---------------	--------	---	----



**5021  
MINICAL**

tech. broch. 01054

Automatic air vent.  
In hot-stamped brass.  
Chrome plated.  
With automatic shut-off cock.  
Max. working pressure: 10 bar.  
Max. discharge pressure: 2,5 bar.  
Max. working temperature: 110 °C.



Code

<b>502131</b>	3/8" M	10	100
<b>502141</b>	1/2" M	10	100



Always replace the valve cap with Caleffi 5620 or R59681 AQUASTOP® hygroscopic safety cap (page 68) in all places where inspection is not possible.

**AUTOMATIC AIR VENTS**

**COMPACT**



**5024 ROBOCAL**

tech. broch. 01033

Automatic air vent.  
In hot-stamped brass.  
Max. working pressure: 10 bar.  
Max. discharge pressure: 4 bar.  
Max. working temperature: 115 °C.



Code			
502420	1/4" M	112	-
502430	3/8" M	1	50



**5025 ROBOCAL**

tech. broch. 01033

Automatic air vent.  
In hot-stamped brass.  
With automatic shut-off cock.  
Max. working pressure: 10 bar.  
Max. discharge pressure: 4 bar.  
Max. working temperature: 110 °C.



Code			
502533	3/8" M	10	100
502543	1/2" M	10	100



**5026 ROBOCAL**

tech. broch. 01033

Automatic air vent.  
In hot-stamped brass.  
Max. working pressure: 10 bar.  
Max. discharge pressure: 6 bar.  
Max. working temperature: 115 °C.



Code			
502630	3/8" M	10	50
502640	1/2" M	Without O-Ring seal	10 100
502641	3/8" M	Chrome plated	10 100



**5027 ROBOCAL**

tech. broch. 01033

Automatic air vent.  
In hot-stamped brass.  
With automatic shut-off cock.  
Max. working pressure: 10 bar.  
Max. discharge pressure: 6 bar.  
Max. working temperature: 110 C.



Code			
502730	3/8" M	10	100

**AUTOMATIC AIR VENTS**

**HIGH DISCHARGE CAPACITY**



**501 MAXCAL**

tech. broch. 01031

Automatic air vent for heating, cooling and refrigeration.  
High discharge capacity.  
Brass body and cover, stainless steel internal components.  
Max. working pressure: 16 bar.  
Max. discharge pressure: 6 bar.  
Temperature range: -20-120 °C.



Code			
501500	3/4" F x 3/8" F	1	5



**551 DISCALAIR®**

tech. broch. 01124

High performance automatic air vent.  
Brass body.  
**Female connection.**  
Max. working pressure: 10 bar.  
Max. discharge pressure: 10 bar.  
Temperature range: 0-110 °C.



Code			
551004	1/2"	1	10



**5022 VALCAL**

tech. broch. 01054

Automatic air vent.  
In hot-stamped brass.  
Chrome plated.  
Max. working pressure: 10 bar.  
Max. discharge pressure: 4 bar.  
Max. working temperature: 120 °C.

Code			
502221	1/4" M	1	25
502231	3/8" M	1	25
502241	1/2" M	1	25

**END PLUG FOR RADIATORS WITH AUTOMATIC AIR VENT**



**507  
AERCAL**

tech. broch. 01032

End plug for radiators with automatic air vent. In hot-stamped brass. Chrome plated. With hygroscopic safety cap. With rubber seal. Max. working pressure: 10 bar. Max. discharge pressure: 6 bar. Max. working temperature: 100 °C.

Code			
<b>507611</b>	1" M right	1	25
<b>507621</b>	1" M left	1	25
<b>507711</b>	1 1/4" M right	1	25
<b>507721</b>	1 1/4" M left	1	25



**504  
AERCAL**

tech. broch. 01055

Automatic air vent for radiators. In hot-stamped brass. Chrome plated. With hygroscopic safety cap. Max. working pressure: 10 bar. Max. discharge pressure: 2,5 bar. Max. working temperature: 100 °C.

Code			
<b>504401</b>	1/2" M	1	25
<b>504501</b>	3/4" M	1	25
<b>504611</b>	1" M right	1	25
<b>504621</b>	1" M left	1	25

**ACCESSORIES**



**561**

tech. broch. 01054

Automatic shut-off cock. For automatic air vents 502. series. PTFE seal on thread. Max. working pressure: 10 bar. Max. working temperature: 110 °C.

Code			
<b>561230</b>	1/4" x 3/8" M	50	500
<b>561300</b>	3/8" x 3/8" M	10	-
<b>561340</b>	3/8" x 1/2" M	10	-
<b>561400</b>	1/2" x 1/2" M without PTFE seal on thread	10	-



**R59681  
AQUASTOP**

tech. broch. 01054

Hygroscopic safety cap. For automatic air vents 5020 and 5021 series.

Code			
<b>R59681</b>		1	-



**5620  
AQUASTOP**

tech. broch. 01054

Hygroscopic safety cap. For automatic air vents 5020, 5021, 5022 and 504 series. Chrome plated.

Code			
<b>562000</b>		50	-



**561**

tech. broch. 01054

Automatic shut-off cock. For automatic air vents 5020 and 5022 series. Chrome plated. PTFE seal on thread. Max. working pressure: 10 bar. Max. working temperature: 110 °C.

Code			
<b>561301</b>	3/8" x 3/8" M	10	-
<b>561401</b>	1/2" x 1/2" M without PTFE seal on thread	10	-



**5621**

tech. broch. 01054

Anti-vacuum cap. For automatic air vents 5020, 5021 and 5022 series.

Code			
<b>562100</b>		100	-



**R59720  
AQUASTOP**

tech. broch. 01032

Hygroscopic safety cap. For end plugs 507 series. Chrome plated.

Code			
<b>R59720</b>		1	-



**5622**

tech. broch. 01033

Anti-vacuum cap. For automatic air vents 5026 and 5027 series.

Code			
<b>562200</b>		100	-

MANUAL AIR VENTS



505

tech. broch. 01056

Manual air vent for radiators.  
Chrome plated.  
White POM (acetal resin) knob.  
PTFE seal on thread.  
Max. working pressure: 10 bar.  
Max. working temperature: 90 °C.

Code			
505111	1/8" M	50	-
505121	1/4" M	50	500
505131	3/8" M	50	500



5080

tech. broch. 01056

Automatic hygroscopic air vent for radiators. Chrome plated.  
White POM (acetal resin) knob.  
PTFE seal on thread.  
Max. working pressure: 10 bar.  
Max. working temperature: 100 °C.

Code			
508011	1/8" M	25	-
508021	1/4" M	25	-
508031	3/8" M	25	-
508041	1/2" M	25	-



5055

tech. broch. 01056

Manual air vent for radiators.  
Rubber seal.  
Chrome plated.  
White POM (acetal resin) knob.  
PTFE seal on thread.  
Max. working pressure: 10 bar.  
Max. working temperature: 90 °C.  
PATENT.

Code			
505511	1/8" M	10	100
505521	1/4" M	10	100
505531	3/8" M	10	100
505541	1/2" M	10	50



5081

tech. broch. 01056

Spare hygroscopic cartridge for 5080 series.

Code			
508100	12 p.1,5	25	-

DRAIN COCKS



337

Drain cock.  
**Adjustable outlet.**  
PTFE seal on thread.  
Max. working pressure: 6 bar.  
Max. working temperature: 85 °C.  
Medium: water, glycol solutions.  
Max. percentage of glycol: 30 %.



Code			
337121	1/4"	50	200
337131	3/8"	50	200



337

Drain cock with metal seal.  
**Adjustable outlet.**  
PTFE seal on thread.  
Max. working pressure: 10 bar.  
Max. working temperature: 100 °C.



Code			
337221	1/4"	80	400
337231	3/8"	50	250

Manual air vent for radiators 5055 series

The identifying detail of this valve is an internal seal in a special elastic material which provides a tight seal in relation to limited tightening of the knob and possible temperature changes.

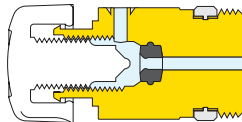

The knob of the valve is shaped so as to be similar in appearance to Caleffi thermostatic valve heads, which enhances the uniformity of the radiator component range.

For all the radiator air vents, the knob should be tightened with the system still cold.



5054

tech. broch. 01056

Manual air vent for radiators.  
Chrome plated.  
White POM (acetal resin) knob.  
**Adjustable outlet.**  
PTFE seal on thread.  
Max. working pressure: 10 bar.  
Max. working temperature: 90 °C.

Code			
505411	1/8" M	50	-
505421	1/4" M	50	-
505431	3/8" M	50	-
505441	1/2" M	50	-



560

tech. broch. 01056

Drain cock for radiators and wall-mounted boilers.  
Chrome plated.  
Max. working pressure: 10 bar.  
Max. working temperature: 100 °C.

Code			
560421	1/2"	10	-
560000	extractor drain hose	25	-

♦ One extractor drain hose code 560000 is included in each 10-item package

**Deaerators - installation at air collection points**

**ALL SYSTEM TYPES**

**AUTOMATIC AIR VENT VALVE**

	<p><b>DISCALAIR®</b> <b>551</b> 1/2"</p>
---	--

**Deaerators - in-line installation**

**WALL-MOUNTED BOILER SYSTEMS**

**TECHNOPOLYMER DEAERATOR**

	<p><b>DISCALSLIM®</b> <b>551</b> 3/4" – 1" – Ø 18 – Ø 22</p>
---	--

**WALL-MOUNTED BOILER SYSTEMS WITH TECHNICAL ROOM**

**BRASS DEAERATOR WITH ADJUSTABLE CONNECTIONS**

	<p><b>DISCAL®</b> <b>551</b> 3/4" – 1" – Ø 22 – Ø 28</p>
---	--

**HEAT PUMP SYSTEMS**

**HIGH-EFFICIENCY DEAERATOR FOR HEAT PUMP SYSTEMS**

	<p><b>CALEFFI HED®</b> <b>5516</b> 1" – 1 1/4" – Ø 22 – Ø 28</p>
---	--

**MEDIUM/LARGE SYSTEMS**

BRASS DEAERATOR		STEEL DEAERATOR	
	<p><b>DISCAL®</b> <b>551</b> 3/4" – 2"</p>		<p><b>DISCAL®</b> <b>551</b> DN 50–DN 65</p>

**LARGE SYSTEMS**

**STEEL DEAERATOR**

	<p><b>DISCAL®</b> <b>551</b> DN 50–DN 300</p>
---	---



HIGH-EFFICIENCY DEAERATORS AT AIR COLLECTION POINTS



**551 DISCALAIR®** tech. broch. 01124

High performance automatic air vent.  
 Brass body. **Female connection.**  
 Max. working pressure: 10 bar.  
 Max. discharge pressure: 10 bar.  
 Temperature range: 0–110 °C.

Code

<b>551004</b>	1/2"
---------------	------

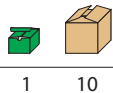

UNDER-BOILER DEAERATOR



**551 DISCALSLIM®** tech. broch. 01337

Deaerator. Technopolymer body.  
**Female connections.**  
**Adjustable for horizontal and vertical pipes.**  
 With hygroscopic safety cap.  
 Max. working pressure: 3 bar.  
 Max. working temperature: 110 °C.  
 PATENT PENDING.

Code

<b>551805</b>	3/4" F
<b>551806</b>	1" F



Insulation for deaerators  
 DISCALSLIM® 551 series.

Code

<b>CBN551805</b>
------------------

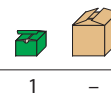

**551 DISCALSLIM®** tech. broch. 01337

Deaerator. Technopolymer body.  
**Ø 18 and Ø 22 mm with compression ends.**  
**Adjustable for horizontal and vertical pipes.**  
 With hygroscopic safety cap.  
 Max. working pressure: 3 bar.  
 Max. working temperature: 110 °C.  
 PATENT PENDING.

Code

<b>551801</b>	Ø 18
<b>551802</b>	Ø 22



WALL-MOUNTED BOILER SYSTEMS WITH TECHNICAL ROOM





**551 DISCAL®**

tech. broch. 01060

Deaerator. Brass body.  
**Female and male connections and Ø 22 and Ø 28 mm with compression ends.**  
**Adjustable for horizontal and vertical pipes.**  
 Max. working pressure: 10 bar.  
 Max. discharge pressure: 10 bar.  
 Temperature range: 0–110 °C.

**Threaded connections**

Code			
551705	3/4" F	1	5
551706	1" F	1	5
551716	1" M	1	5

**Compression ends**

Code			
551702	Ø 22	1	5
551703	Ø 28	1	5



**551 DISCAL®**

tech. broch. 01060

Deaerator. Brass body.  
**Female connections and Ø 22 mm with compression ends.**  
 Max. working pressure: 10 bar.  
 Max. discharge pressure: 10 bar.  
 Temperature range: 0–110 °C.

**Threaded connections**

Code			
551003	3/4" F	1	5

**Compression ends**

Code			
551002	Ø 22	1	5

HIGH-EFFICIENCY DEAERATOR FOR HEAT PUMP SYSTEMS

NEW

5516  
CALEFFI HED®

tech. broch 01416

High-efficiency deaerator.  
Technopolymer body.  
**Adjustable for horizontal, vertical and angled installations.**  
With hygroscopic safety cap.  
Max. working pressure: 3 bar.  
Temperature range: 0–90 °C.  
PATENT PENDING.

PCT  
INTERNATIONAL  
APPLICATION  
PENDING



Threaded connections

Code			
551606	1" F	1	-
551607	1 1/4" F	1	-
551617	1 1/4" M	1	-

Compression ends

Code			
551602	Ø 22	1	-
551603	Ø 28	1	-



Insulation  
for high-efficiency deaerators.

Code	Use		
CBN551602	551606/607	1	-



Pressure gauge.

Code	bar	Conn.	Position	Ø		
F0002253	0–4	clip	central	50	1	1

Horizontal installation

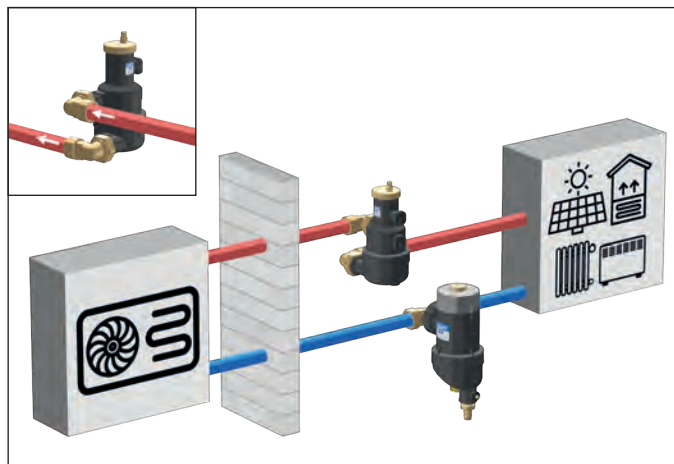

Vertical installation

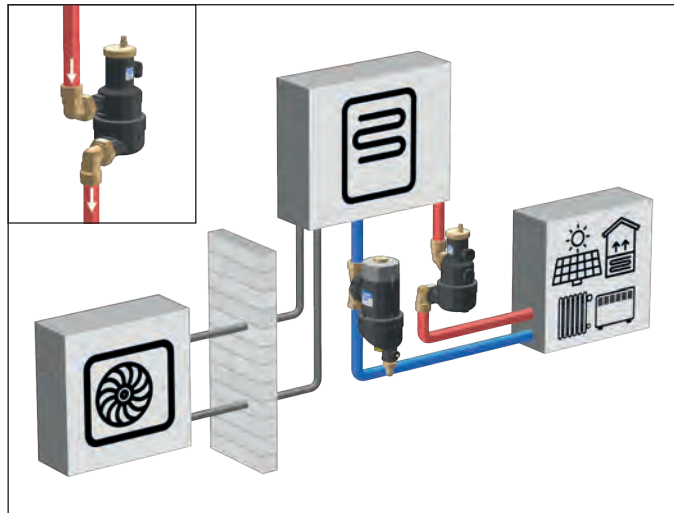

Angled installation

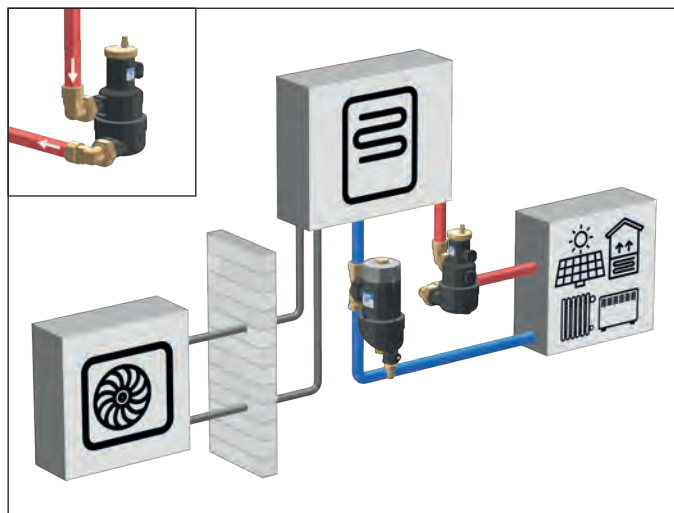

**DEAERATORS FOR MEDIUM SYSTEMS**



**551 DISCAL®**



tech. broch. 01060

Deaerator. Brass body.  
**Female connections.**  
**With drain.**  
 Max. working pressure: 10 bar.  
 Max. discharge pressure: 10 bar.  
 Temperature range: 0–110 °C.

Code			
<b>551005</b>	3/4" F	1	6
<b>551006</b>	1" F	1	6
<b>551007</b>	1 1/4" F	1	6
<b>551008</b>	1 1/2" F	1	6
<b>551009</b>	2" F	1	–



Insulation for deaerators  
 DISCAL® 551 series.

Code	Use		
<b>CBN551005</b>	551005-551006	1	–
<b>CBN551007</b>	551007-551008	1	–
<b>CBN551009</b>	551009	1	–

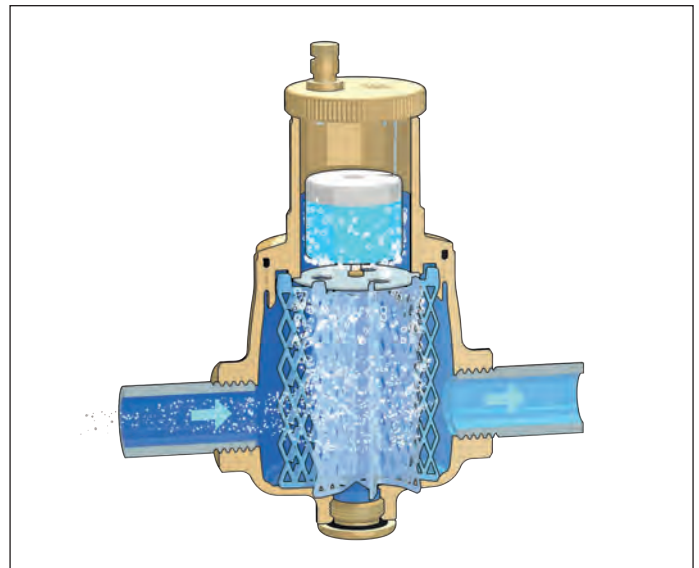
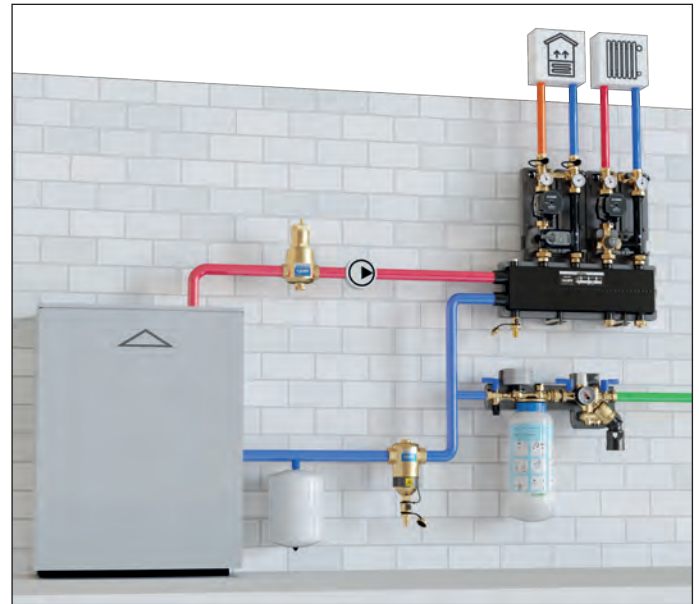

DEAERATOR FOR MEDIUM/LARGE SYSTEMS



**551 DISCAL®**

tech. broch. 01060

Deaerator.  
Epoxy resin coated steel body.  
**Flanged connections PN 16.**  
To be coupled with flat counterflanges EN 1092-1.  
**With insulation.**  
Max. working pressure: 10 bar.  
Max. discharge pressure: 10 bar.  
Temperature range:  
0-105 °C (DN 50-DN 100),  
0-100 °C (DN 125-DN 150),  
0-110 °C (without insulation).

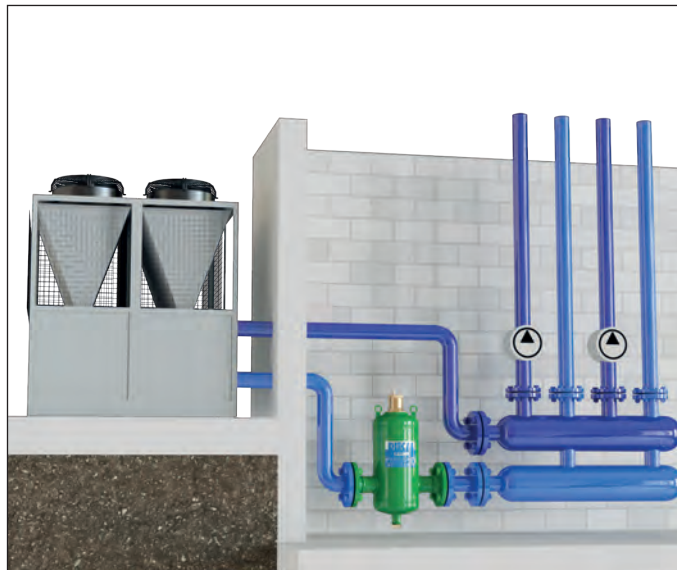

Code

551052	DN 50	1	-
551062	DN 65	1	-
551082	DN 80	1	-
551102	DN 100	1	-
551122	DN 125	1	-
551152	DN 150	1	-



**551 DISCAL®**

tech. broch. 01060

Deaerator.  
Epoxy resin coated steel body.  
**Flanged connections PN 10.**  
To be coupled with flat counterflanges EN 1092-1.  
Max. working pressure: 10 bar.  
Max. discharge pressure: 10 bar.  
Temperature range:  
0-110 °C.  
Temperature probe connection: 1/2" F.



Code

551200	DN 200	1	-
551250	DN 250	1	-
551300	DN 300	1	-



## Deaerators-Dirt separators

These are made by assembling, in a single product, a deaerator and a dirt separator. A single product can therefore be used both to separate air and to separate the impurities present in the system water.

### Operating principle

The device makes use of the combined action of the deaerator and the dirt separator. The internal element creates swirling movements that facilitate the release of micro-bubbles and the subsequent creation of bubbles that then rise to the top of the device, from which they are evacuated by means of an automatic air vent with float. Moreover, the impurities in the water, striking against the surfaces of the internal element, are separated and fall to the bottom of the valve body.

Deaerators-dirt separators fitted with a magnet offer greater efficiency in the separation and collection of ferrous impurities. The impurities are captured inside the dirt separator body by the strong magnetic field created by the magnets inserted in the special outer ring.

With respect to the solutions that call for the installation of separate deaerators and dirt separators, the deaerators-dirt separators present the following advantages: they take up less space and require a smaller number of connections, and are therefore ideal for systems where it is not possible to install the two separate components. Nevertheless, two separate devices will always guarantee a higher performance level.

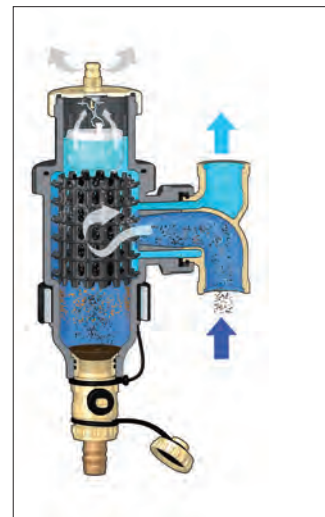

**Sizing**

Sizing a deaerator-dirt separator mainly depends on the speed at which the medium flows through the device, since an excessive speed would not allow correct separation of air and impurities.

As is known, the medium flow speed depends on the flow rate and the cross section. Remaining within the speed limits therefore means not exceeding certain **maximum** permissible **flow rates** for each size.

## HEAT PUMP SYSTEMS

### TECHNOPOLYMER DEAERATOR-DIRT SEPARATOR WITH MAGNET



	<p><b>DISCALDIRTMAG®</b> <b>5464</b></p> <p>3/4" – 1" - 1 1/4" Ø22 - Ø28</p>
---	--

## WALL-MOUNTED BOILER SYSTEMS WITH TECHNICAL ROOM - COOLING SYSTEMS

### BRASS DEAERATOR-DIRT SEPARATOR WITH MAGNET

	<p><b>DISCALDIRTMAG®</b> <b>5461</b></p> <p>3/4" – 1"</p>
---	---

## MEDIUM/LARGE SYSTEMS

STEEL DEAERATOR-DIRT SEPARATOR WITH MAGNET		STEEL DEAERATOR-DIRT SEPARATOR	
	<p><b>DISCALDIRTMAG®</b> <b>5461</b></p> <p>1 1/2" – 2"</p>		<p><b>DISCALDIRT®</b> <b>546</b></p> <p>DN 50–DN 65</p>

## LARGE SYSTEMS

### STEEL DEAERATOR-DIRT SEPARATOR

	<p><b>DISCALDIRT®</b> <b>546</b></p> <p>DN 80–DN 300</p>
---	--

DEAERATORS-DIRT SEPARATORS WITH MAGNET



**5464**  
**DISCALDIRTMAG**

Deaerator-dirt separator **with magnet**.  
Technopolymer body.  
**Female connections.**  
**Adjustable for horizontal and vertical pipes.**  
With hygroscopic safety cap.  
Drain cock with hose connection.  
Max. working pressure: 3 bar.  
Temperature range: 0–90 °C.



**Threaded connections**

Code			
<b>546405</b>	3/4"	1	5
<b>546406</b>	1"	1	5
<b>546407</b>	1 1/4"	1	5

**Compression ends**

Code			
<b>546402</b>	Ø 22	1	–
<b>546403</b>	Ø 28	1	–

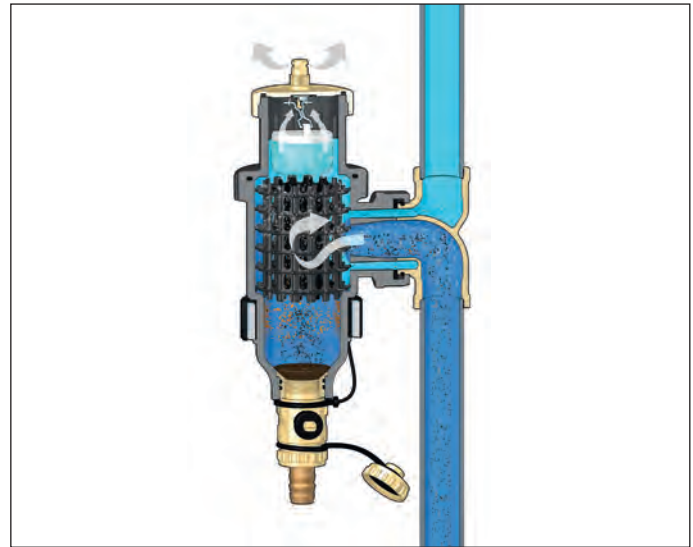

**5461** tech. broch. 01123  
**DISCALDIRTMAG**

Deaerator-dirt separator **with magnet**.  
Brass body.  
**Female connections.**  
Drain cock with hose connection.  
Max. working pressure: 10 bar.  
Max. discharge pressure: 10 bar.  
Temperature range: 0–110 °C.  
Particle separation rating down to 5 µm.



Code			
<b>546105</b>	3/4"	1	–
<b>546106</b>	1"	1	–
<b>546107</b>	1 1/4"	1	–



**5461** tech. broch. 01123  
**DISCALDIRTMAG**

Deaerator-dirt separator **with magnet**.  
Epoxy resin coated steel body.  
**Female union connections.**  
**With insulation.**  
Drain cock with hose connection.  
Max. working pressure: 10 bar.  
Max. discharge pressure: 10 bar.  
Temperature range: 0–100 °C.  
Particle separation rating down to 5 µm.



Code			
<b>546118</b>	1 1/2"	1	–
<b>546119</b>	2"	1	–



Insulation  
for deaerators-dirt separators 5461 and  
546 series.

Code	Use		
<b>CBN546002</b>	546005-546006-546105-546106	1	–
<b>CBN546007</b>	546007-546107	1	–

DEAERATOR-DIRT SEPARATOR



**546 DISCALDIRT®**

tech. broch. 01123

Deaerator-dirt separator.  
Brass body.  
**Female connections and Ø 22 mm with compression ends.**  
Drain cock with hose connection.  
Max. working pressure: 10 bar.  
Max. discharge pressure: 10 bar.  
Temperature range: 0–110 °C.  
Particle separation rating down to 5 µm.

**Threaded connections**

Code			
<b>546005</b>	3/4"	1	–
<b>546006</b>	1"	1	5
<b>546007</b>	1 1/4"	1	–

**Compression ends**

Code			
<b>546002</b>	Ø 22	1	–



Insulation  
for deaerators-dirt separators 5461 and 546 series.

Code	Use		
<b>CBN546002</b>	546005-546006-546105-546106	1	–
<b>CBN546007</b>	546007-546107	1	–



**546 DISCALDIRT®**

tech. broch. 01123

Deaerator-dirt separator.  
Epoxy resin coated steel body.  
**Flanged connections PN 16.**  
To be coupled with flat counterflanges EN 1092-1.  
**With insulation.**  
Max. working pressure: 10 bar.  
Max. discharge pressure: 10 bar.  
Temperature range:  
0–105 °C (DN 50–DN 100),  
0–100 °C (DN 125–DN 150),  
0–110 °C (without insulation).  
Particle separation rating down to 5 µm.

Code			
<b>546052</b>	DN 50	1	–
<b>546062</b>	DN 65	1	–
<b>546082</b>	DN 80	1	–
<b>546102</b>	DN 100	1	–
<b>546122</b>	DN 125	1	–
<b>546152</b>	DN 150	1	–



**546 DISCALDIRT®**

tech. broch. 01123

Deaerator-dirt separator.  
Epoxy resin coated steel body.  
**Flanged connections PN 10.**  
To be coupled with flat counterflanges EN 1092-1.  
**With insulation.**  
Max. working pressure: 10 bar.  
Max. discharge pressure: 10 bar.  
Temperature range: 0–110 °C.  
Particle separation rating down to 5 µm.

Code			
<b>546200</b>	DN 200	1	–
<b>546250</b>	DN 250	1	–
<b>546300</b>	DN 300	1	–



## Domestic hot water treatment - Polyphosphate dispenser

### Operating principle

Scaling is the result of calcium and magnesium (the salts that determine water hardness) becoming deposited on the pipe walls, heat exchanger surfaces and control and regulation components. The amount of deposit depends on:

- the water temperature
- the water hardness
- the volume of water used.

Unlike other salts, calcium and magnesium salts become less soluble as temperature increases. For this reason, all systems in which water is heated, especially those used for domestic hot water production, are at risk of scaling.

The parameter to monitor is the total hardness, the sum of the concentration of calcium and magnesium ions responsible for scaling. Calcium and magnesium bicarbonates are chemically balanced with the calcium and magnesium carbonates, water and carbon dioxide. As temperature increases, the soluble bicarbonates become insoluble carbonates, forming limescale and releasing carbon dioxide.

Sodium and potassium polyphosphates (food polyphosphates) inside the container combine with calcium and magnesium ions (in the water) to form a chemical compound similar to limescale but which cannot adhere to pipe surfaces.

A shielding is then formed which prevents the precipitation of calcium and magnesium and the consequent formation of limescale deposits.

The polyphosphates, moreover, get deposited on the surface of the pipes, forming a protective film to protect them from scaling.

### Construction details

#### Double Venturi proportional dosage

To keep the polyphosphate dosage efficient, dispensing must take place continuously and in a controlled manner, both with the minimum flow rate at the tap and with a variable water flow rate. This dosage maintains the protective film on the pipes and combats the precipitation of salts.

The Caleffi double Venturi proportional dispensing system features full mechanical operation and does not require an electric supply. Part of the inlet water flow passes through the first Venturi and only a minimal part passes through the second Venturi.

This innovative double Venturi proportional dispensing system allows a very precise dosing of polyphosphates, just underneath the average value of 5 mg/l (expressed as  $P_2O_5$ ).

#### Check valve

The dispenser has two check valves: one at the inlet, upstream of the shut-off ball, to ensure the non-return of the water treated in the system and one downstream, to limit excessive dispersion of salts inside the pipes in the case of prolonged inactivity.

#### Air vent

The air vent makes it possible to eliminate air from the container and to lower the pressure inside the device before refilling takes place.

#### Design

The special white and chrome-plated finish means that the dispenser easily adapts to the domestic environment. Its very small dimensions make it suitable for installation on most wall-mounted boilers, regardless of whether they are installed in new or renovated systems. It can be installed underneath the boiler, next to the 5459 series magnetic filter.

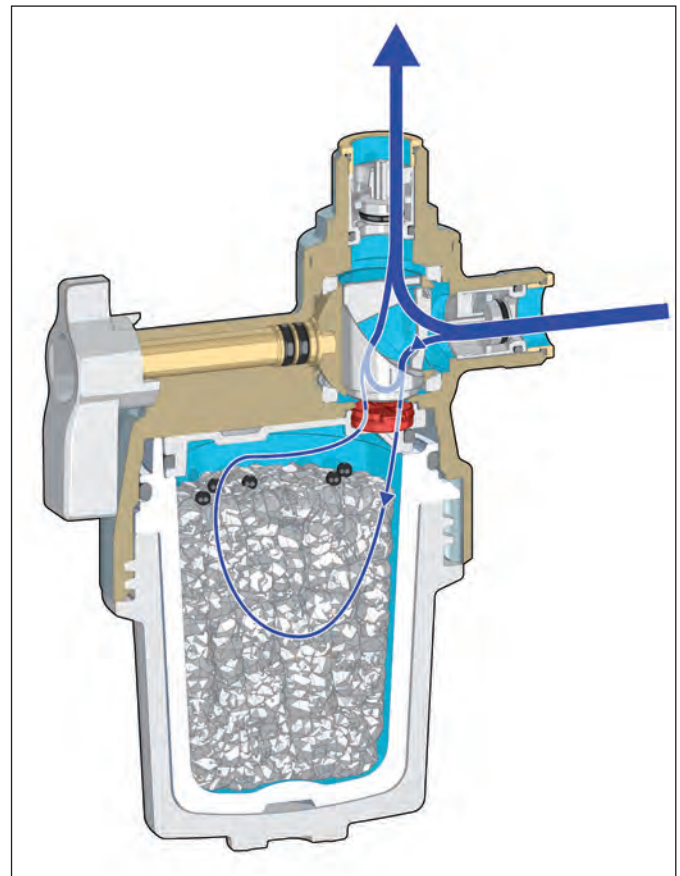

*Equipment for domestic use, for the treatment of potable water.*

*When using the polyphosphate crystal treatment, check current national regulations.*

*Italy: the use of polyphosphates is classed as a chemical conditioning treatment (as expressed in UNI 8065) which is based on the dispensing of salts in proportion to the amount of cold water passing through the device, without changing the water hardness.*

### Caleffi XP - 5459 series

#### Crystal refill duration

Average value: 35–40 m<sup>3</sup> domestic hot water. Data refers to water with an average hardness of 12 °f, pH 7, temperature 20 °C and average domestic hot water usage. The polyphosphate fill status can be monitored easily through the clear windows, which can be used to check the level of the dark-coloured pellets.

*We do not recommend heating domestic hot water to over 70 °C, to avoid compromising the properties of the polyphosphates.*



**UNDER-BOILER POLYPHOSPHATE DISPENSER**

**5459  
CALEFFI XP**

tech. broch. 01375



Under-boiler polyphosphate dispenser.  
**For the treatment of potable water.**  
 Brass body. Chrome plated.  
 Connections: 1/2" M x 1/2" F captive nut.  
 Max. working pressure: 6 bar.  
 Working temperature range: 5–40 °C.  
 Ambient temperature range: 40 °C.  
 Average crystal refill shelf life:  
 35–40 m<sup>3</sup> domestic hot water (\*)  
 Only use genuine refills code F0001503.  
 Complete with polyphosphate crystal refill.  
**PATENT PENDING.**

(\*) data referring to water with an average hardness of 12°, pH 7, temperature 20 °C and average domestic hot water usage.

Code				
545950	1/2" M x 1/2" F		1	5
545951	1/2" M x 1/2" F	without crystal refill	1	5



Polyphosphate crystal refill.  
 Complete with spare internal strainer.  
 For dispenser code 545950, 545951.

Code				
F0001503			1	-



Insulation  
 for polyphosphate dispenser 5459 series.

Code				
CBN545950			1	-

Installation on the domestic water circuit at the cold water inlet to the boiler.

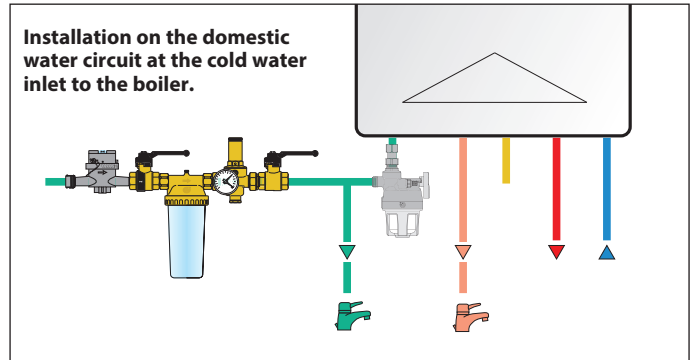

**Polyphosphate refill**

Polyphosphate crystals are mixed with dark-coloured rubber granules, useful for checking the level of crystals directly through the device's transparent windows. One refill is sufficient to fill the dispenser completely. Refill the device when the dark granules can be seen on the bottom of the glass and the crystals are no longer visible.



**Double X protection**

Package consisting of:  
 - Under-boiler magnetic filter;  
 - Under-boiler polyphosphate dispenser.



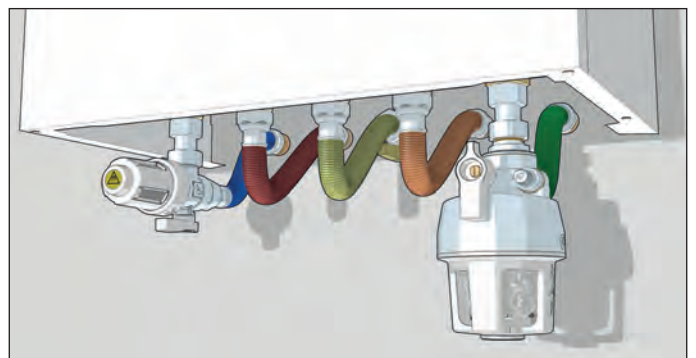

Code				
KIT5459			1	-





**CHEMICAL WATER TREATMENT**

**LIQUID CHEMICAL ADDITIVES**

**5709 C3 CLEANER** tech. broch. 01345

Removes sludge, limescale and debris.  
Dose:  
**0,5 litres of product every 150 litres of water in the system.**

Code  

---

**570911** 0,5 litres 6 -

**5709 C1 INHIBITOR** tech. broch. 01345

Protects against corrosion and limescale.  
Dose:  
**0,5 litres of product every 150 litres of water in the system.**

Code   



---

**570912** 0,5 litres 6 -



**5709 C7 BIOCIDES** tech. broch. 01345

Prevents bacterial and fungal growth.  
Dose:  
**0,5 litres of product every 150 litres of water in the system.**

Code  

---

**570913** 0,5 litres 6 -



**5709 C4 LEAK SEALER** tech. broch. 01345

Liquid sealer.  
Dose:  
**0,5 litres of product every 150 litres of water in the system.**

Code  

---

**570914** 0,5 litres 6 -

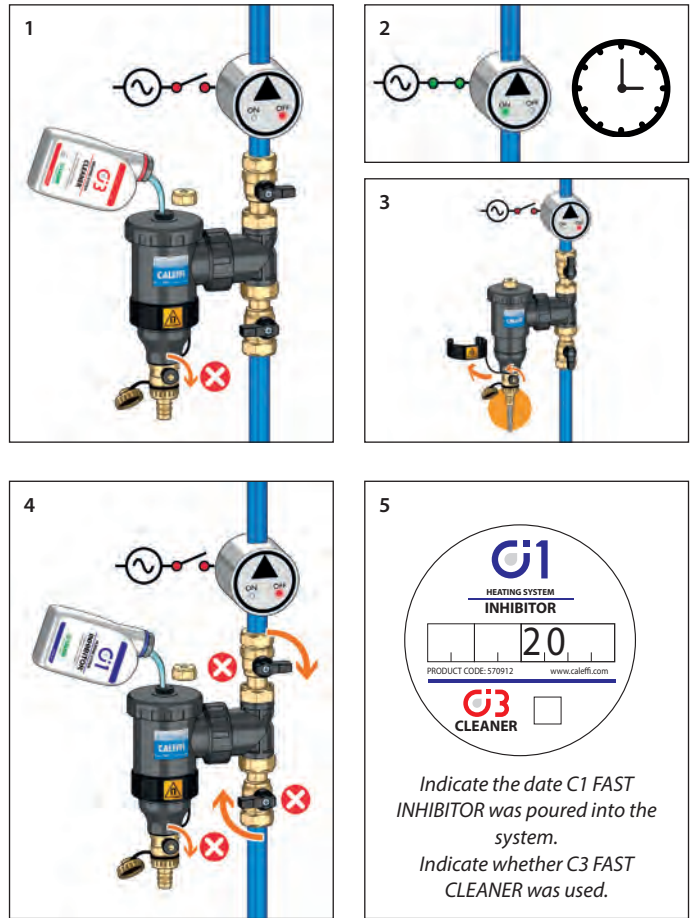

CHEMICAL WATER TREATMENT

PRESSURISED CHEMICAL ADDITIVES



**5709 C3 FAST CLEANER** tech. broch. 01345

Removes sludge, limescale and debris.  
Dose:  
**0,4 litres of product every 150 litres of water in the system.**



Code **570915** 0,4 litres   1 4

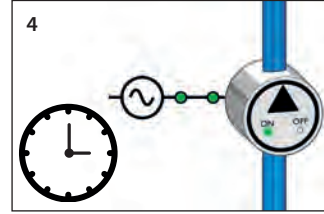
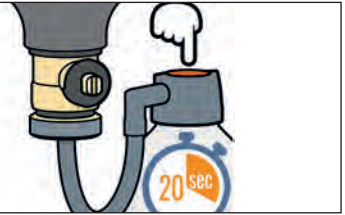
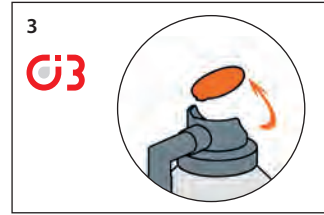

**5709 C1 FAST INHIBITOR** tech. broch. 01345





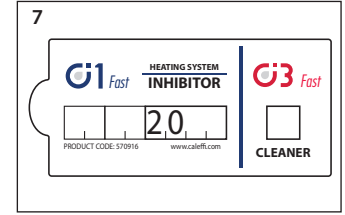

Protects against corrosion and limescale.  
Dose:  
**0,4 litres of product every 150 litres of water in the system.**



Code **570916** 0,4 litres   1 4



Treatment summary

	System cleaning	Washing and sanitising	Protection against corrosion and limescale	Protection against bacterial growth	Repair of microfissures
 C3 CLEANER	●	●			
 C3 FAST CLEANER	●	●			
 C1 INHIBITOR			●		
 C1 FAST INHIBITOR			●		
 C7 BIOCIDES		●		●	
 C4 LEAK SEALER					●

Cleaning and washing treatments: pour into the system and leave to circulate for the required time. Then drain the system to eliminate the impurities collected in the dirt separator.

Protective treatments: use in the system and check once a year.

Treatment "as needed" for minor leaks. Leave in the system.

## AUTOMATIC WATER TREATMENT UNIT

### 580020

tech. broch. 01360

Automatic water treatment unit for softening and demineralisation. It includes a positive displacement meter with built-in conductivity measuring cell, by-pass regulator, downstream ball shut-off valve, drain cock and air vent cock.

**With insulation.**  
Working temperature range: 4–30 °C.  
Max. working pressure: 4 bar.  
Max. working temperature: 30 °C.



Code			
580020	1/2"	1	-

#### Function

The automatic water treatment unit, installed on the inlet pipe, is used to treat water in the closed circuits of heating and cooling systems. It is complete with a by-pass regulator to adjust the outlet water hardness at the softening treatment.

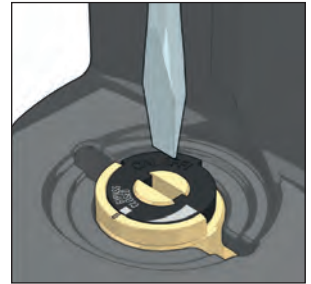

#### Electronic controller

The unit is equipped with an electronic controller, which is capable of handling water demineralisation and softening treatments alike. It is possible to set parameters and data relating to a specific treatment, directly from the front panel of the controller. The software will automatically calculate all parameters for correct operation (refer to instruction sheet H0007428).



### 580011

tech. broch. 01361

Automatic compact charging unit to EN 1717 standard with **BA type** backflow preventer, shut-off valve, strainer, pressure test ports for controlling the backflow preventer, pressure reducing valve.

For horizontal or vertical installations.  
Brass body.  
**With insulation.**  
Filling unit setting pressure range: 0,8–4 bar.  
Max. working pressure: 10 bar.  
Max. working temperature: 65 °C.  
Backflow preventer certified to EN 12729 standard.  
Pressure reducing valve certified to EN 1567 standard.  
PATENT.



Code			
580011	1/2"	1	5



#### Backflow prevention reference standards

To avoid water backflow from the heating system, which is polluted and hazardous for human health, **it is indispensable to install an automatic charging unit with a backflow preventer.** The correct use of hydraulic backflow preventers is governed by the European reference standard EN 1717: 2000 ("Protection against pollution of potable water in water installations and general requirements of devices to prevent pollution by backflow").



Connection fitting with nut and gasket. For codes 580020 and 580011.

Code			
F0001298	3/4" F x 3/4" F	1	-

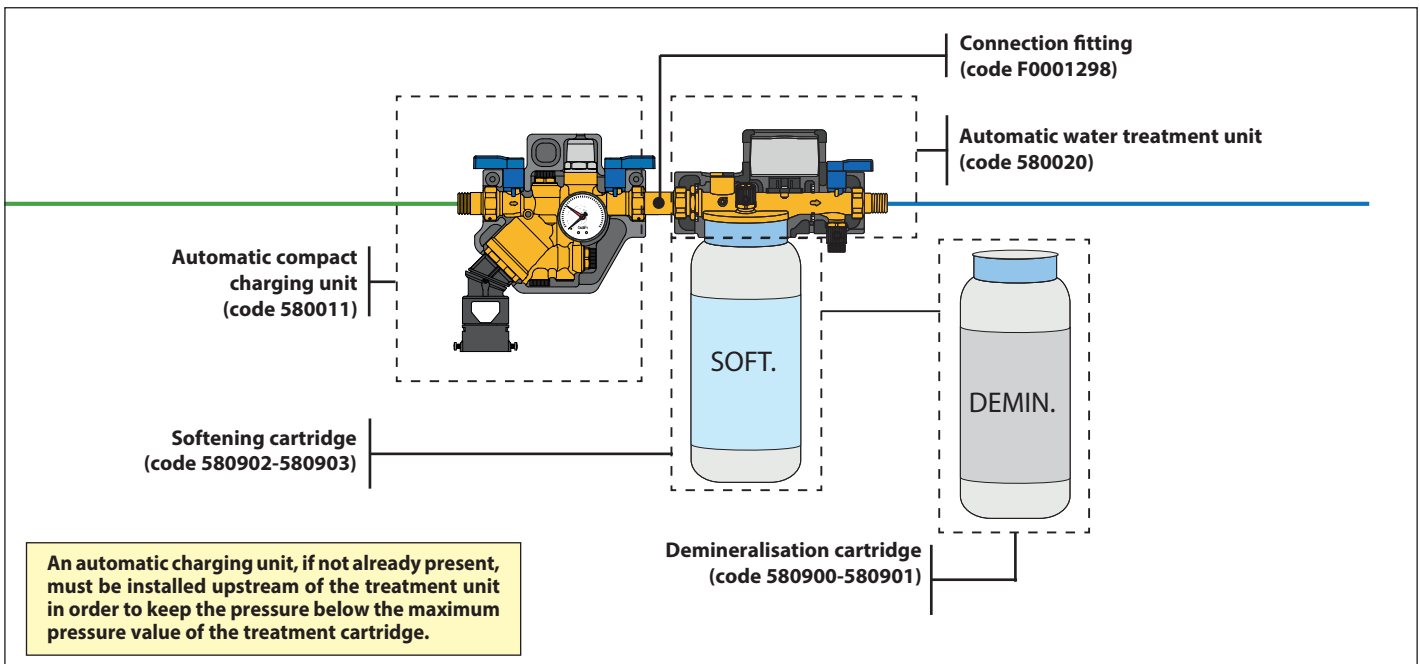

**SOFTENING CARTRIDGE**

**580**

tech. broch. 01360



Disposable softening cartridge.  
 Max. working pressure: 4 bar.  
 Working temperature range: 4–30 °C.  
 Warehouse storage temperature range: 0–40 °C.  
 Nominal flow rate: 2 l/min (code 580902),  
 4 l/min (code 580903).

Code	Dimensioning coefficient (hardness °f)	Dimensioning coefficient (hardness °dH)		
580902	26	14	1	–
580903	43	24	1	–



**5750**

Hardness measurement kit.  
 Accuracy: 1°f / 1°dH.

Code		
575003	1	–

**Softening cartridge sizing**

The volume of treatable water depends on the hardness of the filling water and must be calculated as follows:

$$\text{Volume of treatable water (m}^3\text{)} = \frac{\text{Dimensioning coefficient}}{\text{hardness IN} - \text{hardness OUT}}$$

hardness IN = raw water hardness (°f/°dH)  
 hardness OUT = treated water hardness (°f/°dH)



**DEMINERALISATION CARTRIDGE**

**580**

tech. broch. 01360



Disposable demineralisation cartridge.  
 Max. working pressure: 4 bar.  
 Working temperature range: 4–30 °C.  
 Warehouse storage temperature range: 0–40 °C.  
 Nominal flow rate: 2 l/min (code 580900),  
 4 l/min (code 580901).

Code	Dimensioning coefficient (residual el. conductivity < 10 µS/cm)	Dimensioning coefficient (residual el. conductivity < 50 µS/cm) (*)		
580900	140	220	1	–
580901	180	280	1	–

(\*) If a full demineralisation treatment is not required (residual conductivity < 10 µS/cm), it is preferable to use the sizing coefficient for residual conductivity < 50 µS/cm.

**Demineralisation cartridge sizing**

The volume of treatable water depends on the electrical conductivity of the filling water, and must be calculated as follows:

$$\text{Volume of treatable water (m}^3\text{)} = \frac{\text{Sizing coefficient}}{\text{Electrical conductivity (µS/cm)}}$$



## VALVES AND ACCESSORIES FOR RADIATORS

3

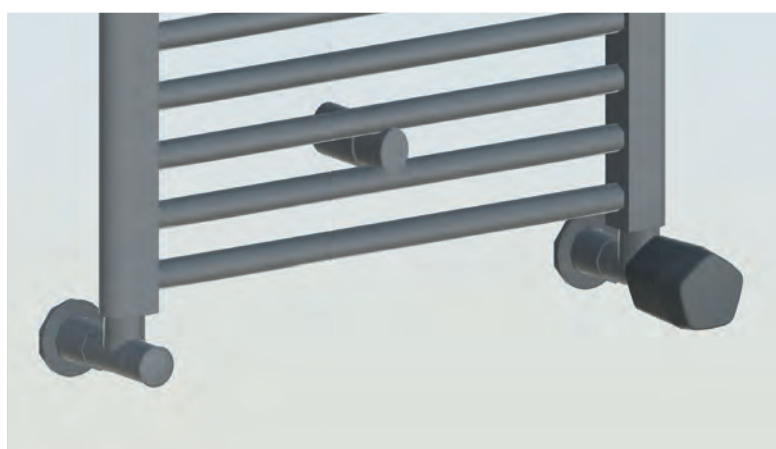
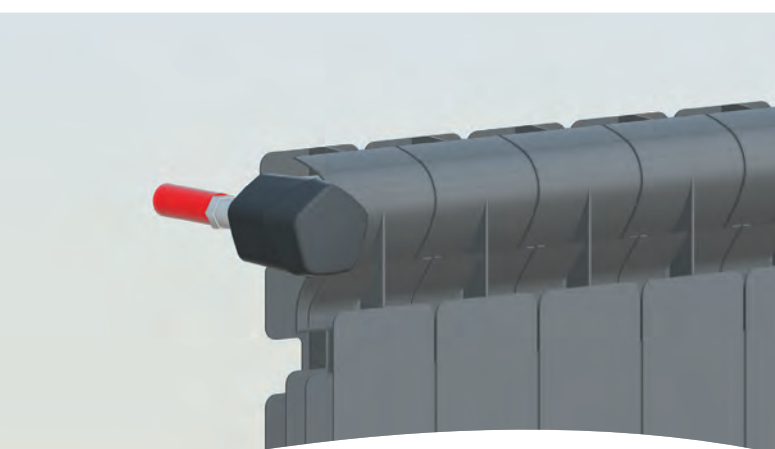
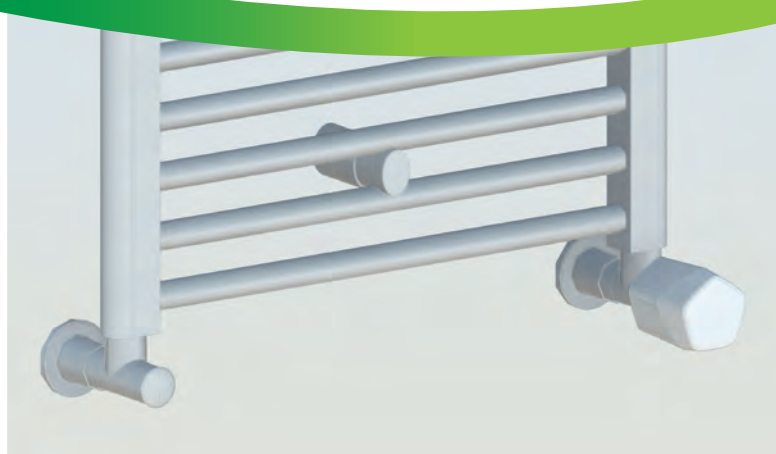
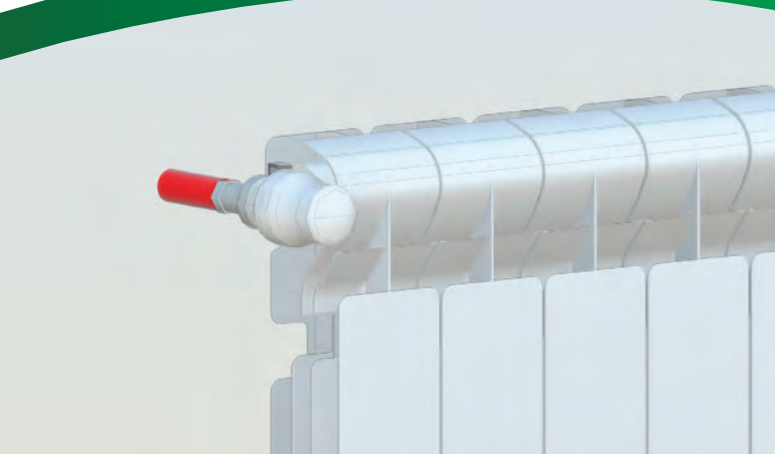

Diagrams made with BIM families: [bim.caleffi.com](http://bim.caleffi.com)

- Convertible radiator and lockshield valves**
- Convertible radiator valves with pre-setting**
- Thermostatic radiator valves**
- Double-angled thermostatic radiator and lockshield valves**
- Dynamic thermostatic radiator valves**
- Thermostatic control heads**
- Remote thermal regulation system for radiators**
- HIGH-STYLE convertible radiator valve**
- Convertible radiator and lockshield valves with push fit connection**
- Wall-covering plates**
- Thermo-electric actuators**
- Manual radiator and lockshield valves**
- One-pipe and two-pipe radiator valves**
- Fittings**
- Calibrator for multilayer pipes**
- Valves for panel radiators**

CONVERTIBLE RADIATOR AND LOCKSHIELD VALVES



338

tech. broch. 01009

Angled convertible radiator valve fitted for thermostatic control heads and thermo-electric actuators. Chrome plated. For copper, single and multilayer plastic pipes. Max. working pressure: 10 bar. Temperature range: 5–100 °C.

Code	Radiator connection	Pipe connection	Kv (m <sup>3</sup> /h)		
338302	3/8"	23 p.1,5	2,22	10	50
338402	1/2"	23 p.1,5	2,70	10	50
338452	1/2"	3/4"	2,70	10	50



342

tech. broch. 01009

Angled lockshield valve. Chrome plated. For copper, single and multilayer plastic pipes. Max. working pressure: 10 bar. Temperature range: 5–100 °C.

Code	Radiator connection	Pipe connection	Kv (m <sup>3</sup> /h) fully open		
342302	3/8"	23 p.1,5	2,42	10	50
342402	1/2"	23 p.1,5	3,99	10	50
342452	1/2"	3/4"	3,99	10	50



339

tech. broch. 01009

Straight convertible radiator valve fitted for thermostatic control heads and thermo-electric actuators. Chrome plated. For copper, single and multilayer plastic pipes. Max. working pressure: 10 bar. Temperature range: 5–100 °C.

Code	Radiator connection	Pipe connection	Kv (m <sup>3</sup> /h)		
339302	3/8"	23 p.1,5	1,35	10	50
339402	1/2"	23 p.1,5	1,79	10	50
339452	1/2"	3/4"	1,79	10	50



343

tech. broch. 01009

Straight lockshield valve. Chrome plated. For copper, single and multilayer plastic pipes. Max. working pressure: 10 bar. Temperature range: 5–100 °C.

Code	Radiator connection	Pipe connection	Kv (m <sup>3</sup> /h) fully open		
343302	3/8"	23 p.1,5	1,32	10	50
343402	1/2"	23 p.1,5	2,17	10	50
343452	1/2"	3/4"	2,17	10	50



401

tech. broch. 01009

Angled convertible radiator valve fitted for thermostatic control heads and thermo-electric actuators. Chrome plated. For steel pipe. Max. working pressure: 10 bar. Temperature range: 5–100 °C.

Code	Radiator connection	Pipe connection	Kv (m <sup>3</sup> /h)		
401302	3/8"		2,22	10	50
401402	1/2"		2,70	10	50
401500	3/4"	without rubber seal	3,36	5	25
401603	1"	without rubber seal	4,47	5	25



431

tech. broch. 01009

Angled lockshield valve. Chrome plated. For steel pipe. Max. working pressure: 10 bar. Temperature range: 5–100 °C.

Code	Radiator connection	Pipe connection	Kv (m <sup>3</sup> /h) fully open		
431302	3/8"		2,42	10	50
431402	1/2"		3,99	10	50
431503	3/4"	without rubber seal	4,52	5	25
431603	1"	without rubber seal	5,64	5	25



402

tech. broch. 01009

Straight convertible radiator valve fitted for thermostatic control heads and thermo-electric actuators. Chrome plated. For steel pipe. Max. working pressure: 10 bar. Temperature range: 5–100 °C.

Code	Radiator connection	Pipe connection	Kv (m <sup>3</sup> /h)		
402302	3/8"		1,35	10	50
402402	1/2"		1,79	10	50
402500	3/4"	without rubber seal	2,58	5	25
402603	1"	without rubber seal	4,43	5	25



432

tech. broch. 01009

Straight lockshield valve. Chrome plated. For steel pipe. Max. working pressure: 10 bar. Temperature range: 5–100 °C.

Code	Radiator connection	Pipe connection	Kv (m <sup>3</sup> /h) fully open		
432302	3/8"		1,32	10	50
432402	1/2"		2,17	10	50
432503	3/4"	without rubber seal	2,58	5	25
432603	1"	without rubber seal	4,81	5	25



CONVERTIBLE RADIATOR VALVES WITH PRE-SETTING



425

tech. broch. 01195

Angled convertible radiator valve fitted for thermostatic control heads and thermo-electric actuators.

**With pre-setting.**

Chrome plated.

For copper, single and multilayer plastic pipes.

Max. working pressure: 10 bar.

Temperature range: 5–100 °C.

Code	Radiator connection	Pipe connection		
425302	3/8"	23 p.1,5	1	50
425402	1/2"	23 p.1,5	1	50



426

tech. broch. 01195

Straight convertible radiator valve fitted for thermostatic control heads and thermo-electric actuators.

**With pre-setting.**

Chrome plated.

For copper, single and multilayer plastic pipes.

Max. working pressure: 10 bar.

Temperature range: 5–100 °C.

Code	Radiator connection	Pipe connection		
426302	3/8"	23 p.1,5	1	50
426402	1/2"	23 p.1,5	1	50



421

tech. broch. 01195

Angled convertible radiator valve fitted for thermostatic control heads and thermo-electric actuators.

**With pre-setting.**

Chrome plated.

For steel pipe.

Max. working pressure: 10 bar.

Temperature range: 5–100 °C.

Code	Radiator connection	Pipe connection		
421302	3/8"		1	50
421402	1/2"		1	50
421500	3/4"	without rubber seal	1	25



422

tech. broch. 01195

Straight convertible radiator valve fitted for thermostatic control heads and thermo-electric actuators.

**With pre-setting.**

Chrome plated.

For steel pipe.

Max. working pressure: 10 bar.

Temperature range: 5–100 °C.

Code	Radiator connection	Pipe connection		
422302	3/8"		1	50
422402	1/2"		1	50
422500	3/4"	without rubber seal	1	25

Pre-setting device

The convertible radiator valves are equipped with an internal device for pre-setting the head loss hydraulic characteristics.

Specific passage cross sections can be selected by means of the control nut, in order to generate the required resistance to the motion of the medium.

Each passage cross section determines a specific Kv value for the creation of the head loss, which corresponds to a setting position on a graduated scale.

Depending on the position in the system, the valve can be pre-set so as to obtain an immediate balancing of the hydraulic circuit, valid for both manual and thermostatic operation.

Pre-setting operation

Remove the valve knob.

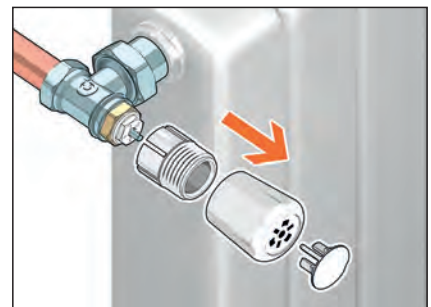

Lift the special control ring nut (supplied in package) of the pre-setting device and turn the control stem to select the required position on the graduated scale.

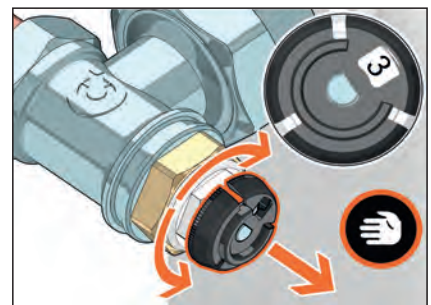

Lower the ring nut again.

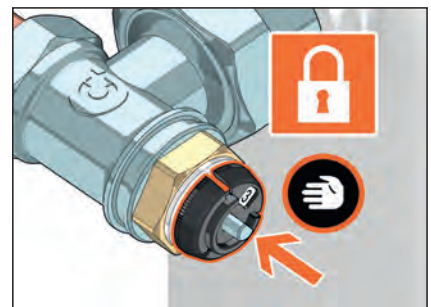

Position the manual knob, thermostatic control head or thermo-electric actuator on the valve.

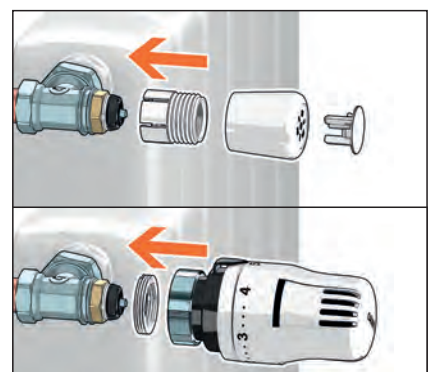



THERMOSTATIC RADIATOR VALVES

220

tech. broch. 01034



Angled thermostatic radiator valve fitted for thermostatic and electronic control heads, thermo-electric actuators. Chrome plated. For steel pipe. Max. working pressure: 10 bar. Temperature range: 5–100 °C.



Code		Kvs (m <sup>3</sup> /h)*		
220302	3/8"	2,29	10	50
220402	1/2"	2,39	10	50
220500	3/4" without rubber seal	3,19	5	25

224

tech. broch. 01034



Reverse thermostatic radiator valve fitted for thermostatic and electronic control heads, thermo-electric actuators. Chrome plated. For steel pipe. Max. working pressure: 10 bar. Temperature range: 5–100 °C.



Code		Kvs (m <sup>3</sup> /h)*		
224302	3/8"	0,93	1	20
224402	1/2"	1,39	1	20

221

tech. broch. 01034



Straight thermostatic radiator valve fitted for thermostatic and electronic control heads, thermo-electric actuators. Chrome plated. For steel pipe. Max. working pressure: 10 bar. Temperature range: 5–100 °C.



Code		Kvs (m <sup>3</sup> /h)*		
221302	3/8"	1,05	10	50
221402	1/2"	1,52	10	50
221500	3/4" without rubber seal	2,20	5	25

227

tech. broch. 01034



Reverse thermostatic radiator valve fitted for thermostatic and electronic control heads, thermo-electric actuators. Chrome plated. For copper, single and multilayer plastic pipes. Max. working pressure: 10 bar. Temperature range: 5–100 °C.



Code	Radiator connection	Pipe connection	Kvs (m <sup>3</sup> /h)*		
227402	1/2"	23 p.1,5	1,39	1	20

222

tech. broch. 01034



Angled thermostatic radiator valve fitted for thermostatic and electronic control heads, thermo-electric actuators. Chrome plated. For copper, single and multilayer plastic pipes. Max. working pressure: 10 bar. Temperature range: 5–100 °C.

Code	Radiator connection	Pipe connection	Kvs (m <sup>3</sup> /h)*		
222302	3/8"	23 p.1,5	2,16	10	50
222402	1/2"	23 p.1,5	2,39	10	50

4490

Knob for thermostatic radiator valves. For valves 220, 221, 222, 223, 224, 225, 226, 227 series.





Code		
449010	1	100

223

tech. broch. 01034



Straight thermostatic radiator valve fitted for thermostatic and electronic control heads, thermo-electric actuators. Chrome plated. For copper, single and multilayer plastic pipes. Max. working pressure: 10 bar. Temperature range: 5–100 °C.

Code	Radiator connection	Pipe connection	Kvs (m <sup>3</sup> /h)*		
223302	3/8"	23 p.1,5	1,45	10	50
223402	1/2"	23 p.1,5	1,52	10	50

\*Kvs: flow rate for the valve equipped with thermostatic control head at the maximum open position.



The EN 215 certification covers the combination of codes 200000/200001 and 201, 204 series thermostatic control heads with valves 220, 221, 222, 223, 224, 225, 226 and 227 series.



DOUBLE-ANGLED THERMOSTATIC RADIATOR AND LOCKSHIELD VALVES



225

tech. broch. 01034

Double-angled thermostatic radiator valve fitted for thermostatic and electronic control heads, thermo-electric actuators.  
**Right-hand version.**  
 Chrome plated.  
 For steel pipe.  
 Max. working pressure: 10 bar.  
 Temperature range: 5–100 °C.

Code		Kvs (m <sup>3</sup> /h)*		
225312	3/8"	0,96	1	20
225412	1/2"	1,40	1	20





225

tech. broch. 01034

Double-angled lockshield valve.  
**Right-hand version.**  
 Chrome plated.  
 For steel pipe.  
 Max. working pressure: 10 bar.  
 Temperature range: 5–100 °C.





Code		Kvs (m <sup>3</sup> /h)*		
225352	3/8"	1,05	1	20
225452	1/2"	1,40	1	20



225

tech. broch. 01034

Double-angled thermostatic radiator valve fitted for thermostatic and electronic control heads, thermo-electric actuators.  
**Left-hand version.**  
 Chrome plated.  
 For steel pipe.  
 Max. working pressure: 10 bar.  
 Temperature range: 5–100 °C.

Code		Kvs (m <sup>3</sup> /h)*		
225322	3/8"	0,96	1	20
225422	1/2"	1,40	1	20





225

tech. broch. 01034

Double-angled lockshield valve.  
**Left-hand version.**  
 Chrome plated.  
 For steel pipe.  
 Max. working pressure: 10 bar.  
 Temperature range: 5–100 °C.





Code		Kvs (m <sup>3</sup> /h)*		
225362	3/8"	1,05	1	20
225462	1/2"	1,40	1	20



226

tech. broch. 01034

Double-angled thermostatic radiator valve fitted for thermostatic and electronic control heads, thermo-electric actuators.  
**Right-hand version.**  
 Chrome plated.  
 For copper, single and multilayer plastic pipes.  
 Max. working pressure: 10 bar.  
 Temperature range: 5–100 °C.

Code	Radiator connection	Pipe connection	Kvs (m <sup>3</sup> /h)*		
226312	3/8"	23 p.1,5	1,35	1	20
226412	1/2"	23 p.1,5	1,40	1	20





226

tech. broch. 01034

Double-angled lockshield valve.  
**Right-hand version.**  
 Chrome plated.  
 For copper, single and multilayer plastic pipes.  
 Max. working pressure: 10 bar.  
 Temperature range: 5–100 °C.





Code	Radiator connection	Pipe connection	Kvs (m <sup>3</sup> /h)*		
226352	3/8"	23 p.1,5	1,35	1	20
226452	1/2"	23 p.1,5	1,40	1	20



226

tech. broch. 01034

Double-angled thermostatic radiator valve fitted for thermostatic and electronic control heads, thermo-electric actuators.  
**Left-hand version.**  
 Chrome plated.  
 For copper, single and multilayer plastic pipes.  
 Max. working pressure: 10 bar.  
 Temperature range: 5–100 °C.

Code	Radiator connection	Pipe connection	Kvs (m <sup>3</sup> /h)*		
226322	3/8"	23 p.1,5	1,35	1	20
226422	1/2"	23 p.1,5	1,40	1	20





226

tech. broch. 01034

Double-angled lockshield valve.  
**Left-hand version.**  
 Chrome plated.  
 For copper, single and multilayer plastic pipes.  
 Max. working pressure: 10 bar.  
 Temperature range: 5–100 °C.



Code	Radiator connection	Pipe connection	Kvs (m <sup>3</sup> /h)*		
226362	3/8"	23 p.1,5	1,35	1	20
226462	1/2"	23 p.1,5	1,40	1	20

DYNAMIC THERMOSTATIC RADIATOR VALVES

**230**  
**DYNAMICAL®**

tech. broch. 01330



Angled dynamic thermostatic radiator valve fitted for thermostatic and electronic control heads, thermo-electric actuators. Chrome plated. For steel pipe. Max. working pressure: 10 bar. Temperature range: 5–95 °C. PATENT.



Code	Radiator connection	Pipe connection	Flow rate range (l/h)	Green box	Orange box
230302	3/8"	20–120		10	50
230312	3/8"	10–80		10	50
230402	1/2"	20–120		10	50
230412	1/2"	10–80		10	50
230500	3/4"	20–120	without rubber seal	5	25

**231**  
**DYNAMICAL®**

tech. broch. 01330



Straight dynamic thermostatic radiator valve fitted for thermostatic and electronic control heads, thermo-electric actuators. Chrome plated. For steel pipe. Max. working pressure: 10 bar. Temperature range: 5–95 °C. PATENT.



Code	Radiator connection	Pipe connection	Flow rate range (l/h)	Green box	Orange box
231302	3/8"	20–120		10	50
231312	3/8"	10–80		10	50
231402	1/2"	20–120		10	50
231412	1/2"	10–80		10	50
231500	3/4"	20–120	without rubber seal	5	25

**232**  
**DYNAMICAL®**

tech. broch. 01330



Angled thermostatic radiator valve fitted for thermostatic and electronic control heads, thermo-electric actuators. Chrome plated. For copper, single and multilayer plastic pipes. Max. working pressure: 10 bar. Temperature range: 5–95 °C. PATENT.



Code	Radiator connection	Pipe connection	Flow rate range (l/h)	Green box	Orange box
232302	3/8"	23 p.1,5	20–120	10	50
232402	1/2"	23 p.1,5	20–120	10	50
232412	1/2"	23 p.1,5	10–80	10	50

**233**  
**DYNAMICAL®**

tech. broch. 01330



Straight dynamic thermostatic radiator valve fitted for thermostatic and electronic control heads, thermo-electric actuators. Chrome plated. For copper, single and multilayer plastic pipes. Max. working pressure: 10 bar. Temperature range: 5–95 °C. PATENT.



Code	Radiator connection	Pipe connection	Flow rate range (l/h)	Green box	Orange box
233302	3/8"	23 p.1,5	20–120	10	50
233402	1/2"	23 p.1,5	20–120	10	50
233412	1/2"	23 p.1,5	10–80		

**234**  
**DYNAMICAL®**

tech. broch. 01330



Reverse dynamic thermostatic radiator valve fitted for thermostatic and electronic control heads, thermo-electric actuators. Chrome plated. For steel pipe. Max. working pressure: 10 bar. Temperature range: 5–95 °C. PATENT.



Code	Radiator connection	Pipe connection	Flow rate range (l/h)	Green box	Orange box
234302	3/8"	20–120		5	25
234402	1/2"	20–120		5	25

**237**  
**DYNAMICAL®**

tech. broch. 01330



Reverse dynamic thermostatic radiator valve fitted for thermostatic and electronic control heads, thermo-electric actuators. Chrome plated. For copper, single and multilayer plastic pipes. Max. working pressure: 10 bar. Temperature range: 5–95 °C. PATENT.



Code	Radiator connection	Pipe connection	Flow rate range (l/h)	Green box	Orange box
237302	3/8"	23 p.1,5	20–120	5	25
237402	1/2"	23 p.1,5	20–120	5	25

**Function**

The DYNAMICAL® valve allows the **automatic dynamic balancing** and **pressure-independent adjustment** of the thermal medium in the radiators of two-pipe heating systems. The device, in conjunction with a thermostatic, electronic or thermo-electric control, combines different functions in a single component.

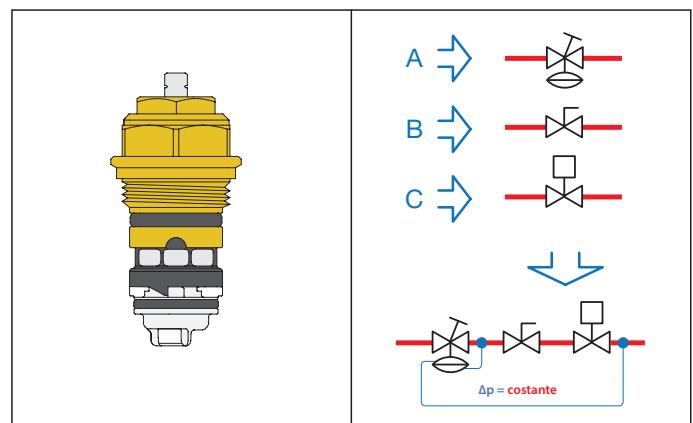

**A. Differential pressure regulator**, which automatically cancels the effect of the pressure fluctuations typical of variable flow rate systems and prevents noisy operation.

**B. Device for pre-setting flow rate**, which allows direct setting of the maximum flow rate value, thanks to the combination with the differential pressure regulator.

**C. Flow rate control depending on the ambient temperature**, thanks to the combination with a thermostatic control head. The flow rate control is optimised because it is pressure-independent.

SPARE PARTS

**3872**

Replacement kit for radiator valves headwork. Equipped with 20 spare headworks (only for valves without pre-setting) **Only for 3/8" and 1/2" valves.**

For valves 338, 339, 401, 402, 425, 426, 421, 422, 230, 231, 232, 233, 234, 237, 220, 221, 222, 223, 224, 225, 226, 227, 456 and 4005.



Code    
**387201** 1 -

**3872**

Adapting kit for headwork tool code 387200 to new headwork tool code 387201.

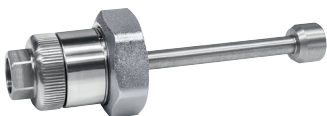

Code    
**387211** 1 -

ΔP MEASURING KIT

**230**

Kit for Δp measuring in the circuits with dynamic valves.



Code    
**230100** 1 -



Spare headworks for convertible and thermostatic radiator valves 338, 339, 401, 402, 220, 221, 222, 223, 224, 227, 225 and 226 series. Only for 3/8" and 1/2" sizes.

Code    
**F39146** 1 -



Spare headworks for convertible radiator valves with pre-setting 425, 426, 421 and 422 series. Only for 3/8" and 1/2" sizes.

Code    
**F49290** 1 -





Spare headworks for dynamic thermostatic radiator valves 230, 231, 232, 233, 234 and 237 series.

Code    
**230000** 1 -



Spare headworks for reverse flow for convertible and thermostatic radiator valves 338, 339, 401, 402, 220, 221, 222, 223, 224, 227, 225 and 226 series. Only for 3/8" and 1/2" sizes.

Code    
**338000** 1 -



Spare headworks for reverse flow for convertible radiator valves with pre-setting 421, 422, 425 and 426 series. Only for 3/8" and 1/2" sizes. PATENT PENDING.

Code    
**421000** 1 -

Installation with reverse flow

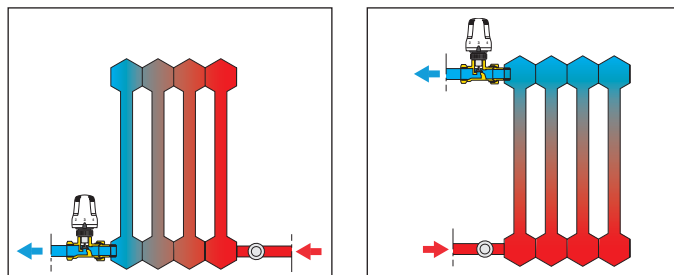

Spare headwork sealing for convertible radiator valves.

Code **F36073**

**THERMOSTATIC CONTROL HEADS**



**200**

tech. broch. 01034

Thermostatic control head for convertible radiator valves. Built-in sensor with liquid-filled element. For valves 338, 339, 401, 402, 425, 426, 421, 422, 230, 231, 232, 233, 234, 237, 220, 221, 222, 223, 224, 225, 226, 227, 455 and 456 series. Graduated scale from \* to 5 corresponding to a temperature adjustment range from 7 °C to 28 °C. With adapter.

Code

**200000**



10 50



**204**

tech. broch. 01242

Thermostatic control head for convertible radiator valves. Built-in sensor with liquid-filled element. For valves 338, 339, 401, 402, 425, 426, 421, 422, 230, 231, 232, 233, 234, 237, 220, 221, 222, 223, 224, 225, 226, 227, 455 and 456 series. Graduated scale from \* to 5 corresponding to a temperature adjustment range from 7 °C to 28 °C. With adapter.

Code

**204000**



10 50



**201**

tech. broch. 01034

Thermostatic control head for thermostatic and convertible radiator valves. With remote sensor. For valves 338, 339, 401, 402, 425, 426, 421, 422, 230, 231, 232, 233, 234, 237, 220, 221, 222, 223, 224, 225, 226, 227, 455 and 456 series. Graduated scale from \* to 5 corresponding to a temperature adjustment range from 7 °C to 28 °C. Capillary length: 2 m. With adapter.

Code

**201000**



1 10



**204**

tech. broch. 01242

Thermostatic control head for thermostatic and convertible radiator valves. With remote sensor. For valves 338, 339, 401, 402, 425, 426, 421, 422, 230, 231, 232, 233, 234, 237, 220, 221, 222, 223, 224, 225, 226, 227, 455 and 456 series. Graduated scale from \* to 5 corresponding to a temperature adjustment range from 7 °C to 28 °C. Capillary length: 2 m. With adapter.

Code

**204100**



1 10



**200**

tech. broch. 01034

Thermostatic control head for convertible radiator valves. Built-in sensor with liquid-filled element. For valves 220, 221, 222, 223, 224, 225, 226, 227, 230, 231, 232, 233, 234 and 237 series. Graduated scale from \* to 5 corresponding to a temperature adjustment range from 7 °C to 28 °C.

Code

**200001**



1 10

THERMOSTATIC CONTROL HEADS



202

tech. broch. 01009

Thermostatic control head for radiator valves. Built-in sensor with liquid-filled element. With LCD type ambient temperature indicator. For valves 338, 339, 401, 402, 425, 426, 421, 422, 230, 231, 232, 233, 234, 237, 220, 221, 222, 223, 224, 225, 226, 227, 455 and 456 series. Graduated scale from \* to 5 corresponding to a temperature adjustment range from 7 °C to 28 °C. Room temperature indicator range: 16–26 °C. With adapter. PATENT.



Visibility with sufficient lighting

Room temperature indicator

The room temperature indicator is a LCD type. It gets green coloured in correspondence with the actual room temperature reading. A particular pivoting system keeps the indicator always in vertical position, thus allowing its optimal visualization.

Code		
202000	1	5



203

tech. broch. 01034

Thermostatic control head for thermostatic and convertible radiator valves; with contact probe, for medium temperature limiting. For valves 220, 221, 222, 223, 224, 225, 226, 227, 338, 339, 401, 402 and 455 series. Pre-set temperature scale. Capillary length: 2 m. With adapter.

Code	Temperature range		
203502	20–50 °C	1	25
203702	40–90 °C	1	–



472

Thermostatic control head with remote adjusting knob, liquid-filled element. For valves 220, 221, 222, 223, 224, 225, 226, 227 series (direct coupling). For valves 338, 339, 401, 402, 455 series (coupling with adapter). Temperature range: 6–28 °C. Capillary length: 2 m.

Code		
472000	1	5

ACCESSORIES FOR THERMOSTATIC CONTROL HEADS



209

tech. broch. 01034

Tamper-proof anti-theft cap for use in public places. For thermostatic control heads 200, 204, 202 and 205 series. To be used with speciale allen key code 209001.

Code		
209000	1	10



475

Contact probe mounting bracket. For thermostatic control heads 203 series.

Code		
475001	1	–



209

tech. broch. 01034

Special allen key for tamper-proof anti-theft cap. To be used with tamperproof cap 209 series.

Code		
209001	1	10



475

Probe pocket. For thermostatic control heads 203 series.

Code		
475002	for code 203502	1 –
475003	for code 203702	1 –

**REMOTE THERMAL REGULATION SYSTEM FOR RADIATORS**

**215**

**Comfort control**

Wireless electronic control for thermostatic or convertible radiator valves. Operates through Gateway, Gateway PRO, APP Caleffi CODE® and front buttons.

Built-in temperature sensor.

Radio communication: RF 868 MHz.

Quick-coupling installation with adapter.

Battery electric supply: 2 x AA batteries 1,5 V (in package).

Compatible with rechargeable batteries.

Protection class: IP 30.

Ambient temperature range: 0–55 °C.

**White colour.**

REGISTERED DESIGN.



Code

**215510**

1

-

tech. broch. 01366

**215**

**Gateway**

Wireless multi-zone temperature regulation gateway.

Operation through Caleffi CODE® APP (Wi-Fi or Ethernet network connectivity required). Weekly programmable clock.

Settable time bands: up to 8 per day. Settable zones: up to 64.

Quick functions: Auto - Eco Mode - Holiday - Manual - OFF - Boost - Clean.

Boiler contact, max. 24 V (DC) 1 A.

Compatible with OpenTherm connectivity.

Radio communication: RF 868 MHz, Wi-Fi, BLE.

Powered from USB type C power supply, (supplied in package),

input: 100–240 V (AC) - 0,5 A 50/60 Hz, output: 5 V (DC), 2 A.

**Class:** IV-VIII [Ecodesign Directive].

Protection class: IP 30.

Ambient temperature range: 0–55 °C.

**White colour.**

REGISTERED DESIGN.



Code

**215100**

1

-

tech. broch. 01366

**215**

**Sensor**

Wireless ambient temperature sensor.

Operates through Gateway, Gateway PRO and APP Caleffi CODE®.

Radio communication: RF 868 MHz.

Battery electric supply: 2 x AAA batteries 1,5 V (in package).

Compatible with rechargeable batteries.

Protection class: IP 30.

Ambient temperature range: 0–45 °C.

**White colour.**

REGISTERED DESIGN.



Code

**215001**

1

-

tech. broch. 01366

**215**

**Gateway PRO**

Wireless multi-zone temperature regulation gateway, **with built-in GSM, UMTS, LTE modem.** Operation through Caleffi CODE® APP.

**It works with micro SIM** (not supplied).

**Compatible with MODBUS-RTU connectivity.**

Weekly programmable clock.

Settable time bands: up to 8 per day. Settable zones: up to 64.

Quick functions: Auto - Eco Mode - Holiday - Manual - OFF - Boost - Clean.

Boiler contact, max. 24 V (DC) 1 A.

Compatible with OpenTherm connectivity.

Radio communication: RF 868 MHz, Wi-Fi, BLE.

Powered from USB type C power supply, (supplied in package),

input: 100–240 V (AC) - 0,5 A 50/60 Hz, output: 5 V (DC), 2 A.

**Class:** IV-VIII [Ecodesign Directive].

Protection class: IP 30.

Ambient temperature range: 0–55 °C.

**White colour.**

REGISTERED DESIGN.



Code

**215015**

1

-

tech. broch. 01366

**215**

**Sensor PRO**

Wireless ambient temperature sensor **with boiler contact.**

Operates through Gateway, Gateway PRO and APP Caleffi CODE®.

Radio communication: RF 868 MHz.

Battery electric supply: 2 x AAA batteries 1,5 V (in package).

Compatible with rechargeable batteries.

Boiler contact, max. 24 V (DC) 1 A.

Protection class: IP 30.

Ambient temperature range: 0–45 °C.

**White colour.**

REGISTERED DESIGN.



Code

**215002**

1

-



**REMOTE THERMAL REGULATION SYSTEM**

The CALEFFI CODE® system guarantees more efficient management of the heating system, giving the user greater savings and the possibility of modifying the programming at any time and from anywhere according to actual needs. Suitable for managing an independent residence or a unit in an apartment block.

**CALEFFI CODE® App**

The system is configured and managed exclusively through the CALEFFI CODE® app for smartphones and tablets (Android® or iOS®) with available internet and Bluetooth® connections.

The system can be controlled by two devices simultaneously, with the CALEFFI CODE® App installed on each device.

Compatible with:



amazon alexa



Google Home



REMOTE THERMAL REGULATION SYSTEM FOR RADIATORS

215

tech. broch. 01366

Comfort control

Wireless electronic control for thermostatic or convertible radiator valves. Operates through Gateway, Gateway PRO, APP Caleffi CODE® and front buttons. Built-in temperature sensor. Radio communication: RF 868 MHz. Quick-coupling installation with adapter. Battery electric supply: 2 x AA batteries 1,5 V (in package). Compatible with rechargeable batteries.

Protection class: IP 30.  
Ambient temperature range: 0–55 °C.  
**Black colour.**  
REGISTERED DESIGN.



Code		
215510 BLK	1	-

215

tech. broch. 01366

Sensor

Wireless ambient temperature sensor. Operates through Gateway, Gateway PRO and APP Caleffi CODE®. Radio communication: RF 868 MHz. Battery electric supply: 2 x AAA batteries 1,5 V (in package). Compatible with rechargeable batteries.

Protection class: IP 30.  
Ambient temperature range: 0–45 °C.  
**Black colour.**  
REGISTERED DESIGN.



Code		
215001 BLK	1	-

215

tech. broch. 01366

Sensor PRO

Wireless ambient temperature sensor **with boiler contact**. Operates through Gateway, Gateway PRO and APP Caleffi CODE®. Radio communication: RF 868 MHz. Battery electric supply: 2 x AAA batteries 1,5 V (in package). Compatible with rechargeable batteries.

Boiler contact, max. 24 V (DC) 1 A.  
Protection class: IP 30.  
Ambient temperature range: 0–45 °C.  
**Black colour.**  
REGISTERED DESIGN.



Code		
215002 BLK	1	-

Accessories for thermal regulation electronic system 215 series.



Code		
21005 tamper-proof kit for actuators	1	10

215

tech. broch. 01366

Gateway

Wireless multi-zone temperature regulation gateway. Operation through Caleffi CODE® APP (Wi-Fi or Ethernet network connectivity required). Weekly programmable clock. Settable time bands: up to 8 per day. Settable zones: up to 64. Quick functions: Auto - Eco Mode - Holiday - Manual - OFF - Boost - Clean. Boiler contact, max. 24 V (DC) 1 A. Compatible with OpenTherm connectivity.

Radio communication: RF 868 MHz, Wi-Fi, BLE. Powered from USB type C power supply, (supplied in package), input: 100–240 V (AC) - 0,5 A 50/60 Hz, output: 5 V (DC), 2 A. **Class: IV-VIII [Ecodesign Directive].** Protection class: IP 30. Ambient temperature range: 0–55 °C. **Black colour.** REGISTERED DESIGN.



Code		
215100 BLK	1	-

215

tech. broch. 01366

Gateway PRO

Wireless multi-zone temperature regulation gateway, **with built-in GSM, UMTS, LTE modem**. Operation through Caleffi CODE® APP. **It works with micro SIM** (not supplied). **Compatible with MODBUS-RTU connectivity.** Weekly programmable clock. Settable time bands: up to 8 per day. Settable zones: up to 64. Quick functions: Auto - Eco Mode - Holiday - Manual - OFF - Boost - Clean. Boiler contact, max. 24 V (DC) 1 A. Compatible with OpenTherm connectivity.

Radio communication: RF 868 MHz, Wi-Fi, BLE. Powered from USB type C power supply, (supplied in package), input: 100–240 V (AC) - 0,5 A 50/60 Hz, output: 5 V (DC), 2 A. **Class: IV-VIII [Ecodesign Directive].** Protection class: IP 30. Ambient temperature range: 0–55 °C. **Black colour.** REGISTERED DESIGN.



Code		
215015 BLK	1	-



Knob for lockshields.

Code		
449300 BLK black colour	1	-

Adapters for thermostatic and convertibles valves not produced by our company.

For RBM - Heimeier - Tiemme - Watts thermostatic valves with M30x1.5mm connection, use the adapter provided.

**Not suitable for use with valves for one-pipe systems**

Code		
210051 for Giacomini valves (R431TG)	1	-
210052 for FAR valves (1610)	1	-
210053 for Watts (1188UM)	1	-
F001597 for Danfoss valves	1	-

HIGH-STYLE CONVERTIBLE RADIATOR VALVES

4001

tech. broch. 01140



- angled-convertible radiator valve fitted for thermostatic control head code 200015;
- angled lockshield valve;
- two pipe-covering/wall-covering shells and allen key.

To be used with fittings 437, 447, 681 and 679 series.

**White colour.**

Max. working pressure: 10 bar.  
Temperature range: 5–100 °C.



Code	Radiator connection	Pipe connection	Kv (m³/h) valve	Kv (m³/h) lockshield valve (f.o.)		
400101	1/2"	23 p.1,5	2,0	1,92	1	5

4003

tech. broch. 01140

- double-angled convertible radiator valve fitted for thermostatic control head code 200015;
- lockshield valve, double-angled connections;
- two pipe-covering/wall-covering shells and allen key.



**Right-hand version.**

To be used with fittings 437, 447, 681 and 679 series.

**White colour.**

Max. working pressure: 10 bar.  
Temperature range: 5–100 °C.



Code	Radiator connection	Pipe connection	Kv (m³/h) valve	Kv (m³/h) lockshield valve (f.o.)		
400301	1/2"	23 p.1,5	1,27	1,37	1	5

4004

tech. broch. 01140

- double-angled convertible radiator valve fitted for thermostatic control head code 200015;
- lockshield valve, double-angled connections;
- two pipe-covering/wall-covering shells and allen key.



**Left-hand version.**

To be used with fittings 437, 447, 681 and 679 series.

**White colour.**

Max. working pressure: 10 bar.  
Temperature range: 5–100 °C.



Code	Radiator connection	Pipe connection	Kv (m³/h) valve	Kv (m³/h) lockshield valve (f.o.)		
400401	1/2"	23 p.1,5	1,27	1,37	1	5

4003

tech. broch. 01140

- double-angled convertible radiator valve fitted for thermostatic control head **205 series**;
- lockshield valve, double-angled connections;
- pipe-covering/wall-covering shell, connections: 50 mm centre distance.

**Central connections.**



**Right-hand version.**

To be used with fittings 437, 447, 681 and 679 series.

**White colour.**

Max. working pressure: 10 bar.  
Temperature range: 5–100 °C.



Code	Radiator connection	Pipe connection	Kv (m³/h) valve	Kv (m³/h) lockshield valve (f.o.)		
400311	1/2"	23 p.1,5	1,27	1,37	1	5

4004

tech. broch. 01140

- double-angled convertible radiator valve fitted for thermostatic control head **205 series**;
- lockshield valve, double-angled connections;
- pipe-covering/wall-covering shell, connections: 50 mm centre distance.

**Central connections.**



**Left-hand version.**

To be used with fittings 437, 447, 681 and 679 series.

**White colour.**

Max. working pressure: 10 bar.  
Temperature range: 5–100 °C.



Code	Radiator connection	Pipe connection	Kv (m³/h) valve	Kv (m³/h) lockshield valve (f.o.)		
400411	1/2"	23 p.1,5	1,27	1,37	1	5

Example of HIGH-STYLE valve installation for designer heating systems with central connection, left-hand version, with thermostatic control head.

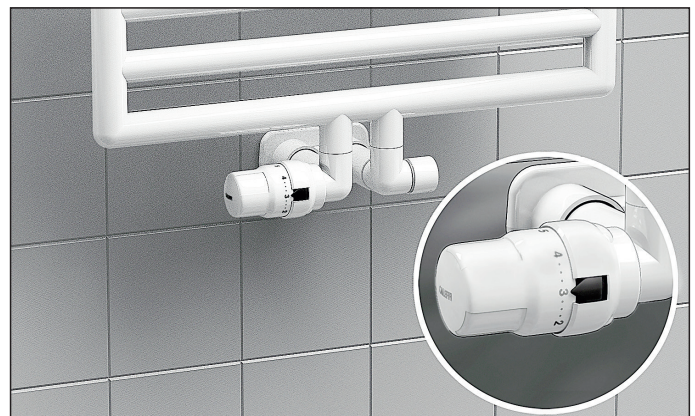

## HIGH-STYLE CONVERTIBLE RADIATOR VALVES WITH CENTRAL CONNECTION



### 205

tech. broch. 01140

Thermostatic control head for designer heating system valves. Built-in sensor with liquid-filled element. For valves 4001, 4003, 4004 and 3380 series.

**White colour.**

Graduated scale from \* to 5 corresponding to a temperature adjustment range from 7 °C to 28 °C. With adapter, tamper-proof cap and special key for tamper-proof cap.



Code

205005

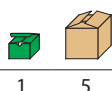

### 205

tech. broch. 01140

Thermostatic control head for designer heating system valves. Built-in sensor with liquid-filled element. For valves 4001, 4003, 4004 and 3380 series.

**White colour.**

Graduated scale from \* to 5 corresponding to a temperature adjustment range from 7 °C to 28 °C. With adapter.



Code

205000

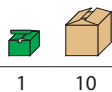

### 209

tech. broch. 01140

Tamper-proof anti-theft cap for use in public places. For thermostatic control heads 200 series.

**High chrome colour.**

To be used with special allen key code 209001.

Code

209000

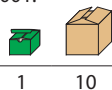

### 209

tech. broch. 01140

Special allen key for tamper-proof anti-theft cap. To be used with tamperproof cap 209 series.

Code

209001

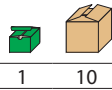

Example of HIGH-STYLE valve installation for designer heating systems, right-hand version, with thermostatic control head

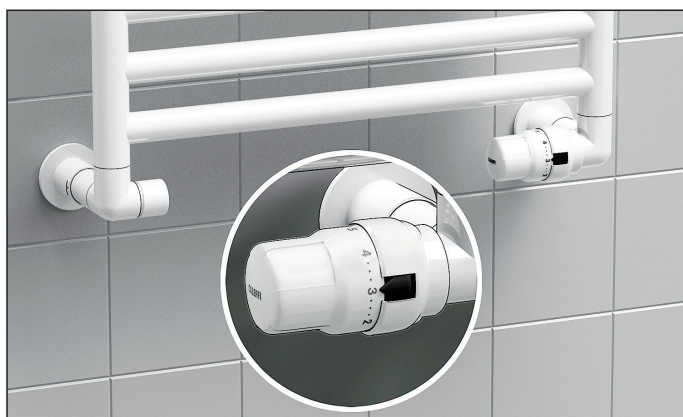

### 215

**Comfort control**

Wireless electronic control for thermostatic or convertible radiator valves. Operates through Gateway, Gateway PRO, APP Caleffi CODE® and front buttons.

Built-in temperature sensor.

Radio communication: RF 868 MHz.

Quick-coupling installation with adapter.

Battery electric supply: 2 x AA batteries 1,5 V (in package).

Compatible with rechargeable batteries.

Protection class: IP 30.

Ambient temperature range: 0–55 °C.

**White colour.**

REGISTERED DESIGN.



Code

215510

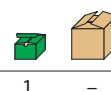

For other CALEFFI CODE® components, refer to page 94

### CALEFFI CODE® connected thermal regulation system

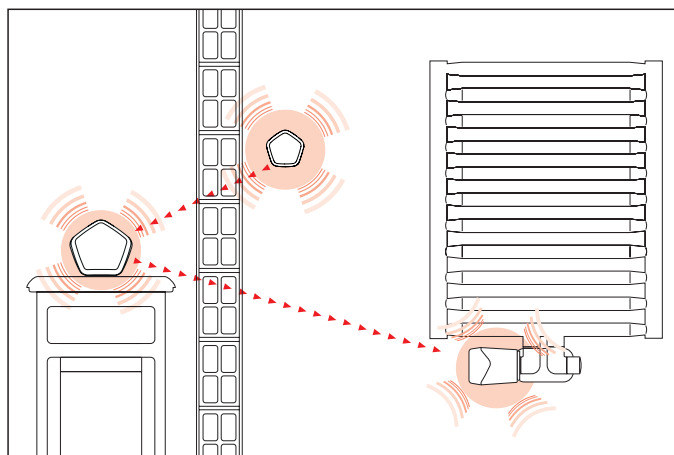

Example of HIGH-STYLE valve installation for designer heating systems with central connection, left-hand version, with electronic control.

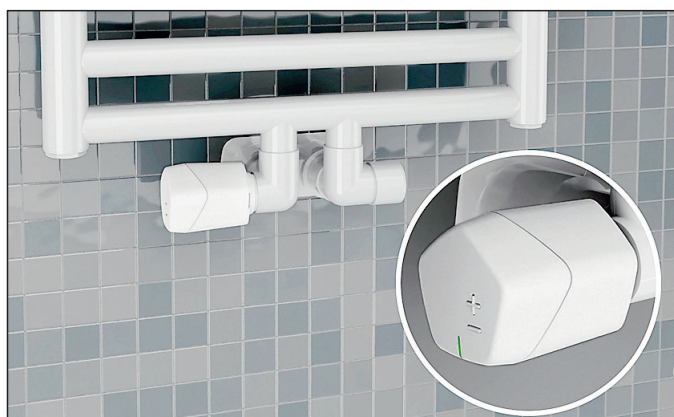

HIGH-STYLE CONVERTIBLE RADIATOR VALVE

4001

tech. broch. 01140

- angled-convertible radiator valve fitted for thermostatic control head code 200015;
- angled lockshield valve;
- two pipe-covering/wall-covering shells and allen key.

To be used with fittings 437, 447, 681 and 679 series.

**Black colour.**

Max. working pressure: 10 bar.

Temperature range: 5–100 °C.



Code	Radiator connection	Pipe connection	Kv (m³/h) valve	Kv (m³/h) lockshield valve (f.o.)		
400103	1/2"	23 p.1,5	2,0	1,92	1	5

4003

tech. broch. 01140

- double-angled convertible radiator valve fitted for thermostatic control head **205 series**;
- lockshield valve, double-angled connections;
- pipe-covering/wall-covering shell, connections: 50 mm centre distance.

**Central connections.**

**Right-hand version.**

To be used with fittings 437, 447, 681 and 679 series.

**Black colour.**

Max. working pressure: 10 bar.

Temperature range: 5–100 °C.



Code	Radiator connection	Pipe connection	Kv (m³/h) valve	Kv (m³/h) lockshield valve (f.o.)		
400313	1/2"	23 p.1,5	1,27	1,37	1	5

4003

tech. broch. 01140

- double-angled convertible radiator valve fitted for thermostatic control head code 200015;
- lockshield valve, double-angled connections;
- two pipe-covering/wall-covering shells and allen key.

**Right-hand version.**

To be used with fittings 437, 447, 681 and 679 series.

**Black colour.**

Max. working pressure: 10 bar.

Temperature range: 5–100 °C.



Code	Radiator connection	Pipe connection	Kv (m³/h) valve	Kv (m³/h) lockshield valve (f.o.)		
400303	1/2"	23 p.1,5	1,27	1,37	1	5

4004

tech. broch. 01140

- double-angled convertible radiator valve fitted for thermostatic control head **205 series**;
- lockshield valve, double-angled connections;
- pipe-covering/wall-covering shell, connections: 50 mm centre distance.

**Central connections.**

**Left-hand version.**

To be used with fittings 437, 447, 681 and 679 series.

**Black colour.**

Max. working pressure: 10 bar.

Temperature range: 5–100 °C.



Code	Radiator connection	Pipe connection	Kv (m³/h) valve	Kv (m³/h) lockshield valve (f.o.)		
400413	1/2"	23 p.1,5	1,27	1,37	1	5

4004

tech. broch. 01140

- double-angled convertible radiator valve fitted for thermostatic control head code 200015;
- lockshield valve, double-angled connections;
- two pipe-covering/wall-covering shells and allen key.

**Left-hand version.**

To be used with fittings 437, 447, 681 and 679 series.

**Black colour.**

Max. working pressure: 10 bar.

Temperature range: 5–100 °C.



Code	Radiator connection	Pipe connection	Kv (m³/h) valve	Kv (m³/h) lockshield valve (f.o.)		
400403	1/2"	23 p.1,5	1,27	1,37	1	5

Example of HIGH-STYLE valve installation for designer heating systems with central connection, left-hand version, with thermostatic control head.



HIGH-STYLE CONVERTIBLE RADIATOR VALVES WITH CENTRAL CONNECTION



205

NEW

tech. broch. 01140

Thermostatic control head for designer heating system valves. Built-in sensor with liquid-filled element. For valves 4001, 4003, 4004 and 3380 series. **Black colour.** Graduated scale from \* to 5 corresponding to a temperature adjustment range from 7 °C to 28 °C. With adapter, tamper-proof cap and special key for tamper-proof cap.

Code

205025

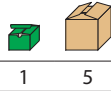

215

tech. broch. 013006

Comfort control

Wireless electronic control for thermostatic or convertible radiator valves. Operates through Gateway, Gateway PRO, APP Caleffi CODE® and front buttons. Built-in temperature sensor. Radio communication: RF 868 MHz. Quick-coupling installation with adapter. Battery electric supply: 2 x AA batteries 1,5 V (in package). Compatible with rechargeable batteries.



Protection class: IP 30. Ambient temperature range: 0-55 °C. **Black colour.** REGISTERED DESIGN.



Code

215510 BLK

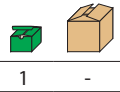

205

NEW

tech. broch. 01140

Thermostatic control head for designer heating system valves. Built-in sensor with liquid-filled element. For valves 4001, 4003, 4004 and 3380 series. **Black colour.** Graduated scale from \* to 5 corresponding to a temperature adjustment range from 7 °C to 28 °C. With adapter.

Code

205023

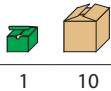

209

NEW

tech. broch. 01140

Tamper-proof anti-theft cap for use in public places. For thermostatic control heads 200 series. **High chrome colour.** To be used with special allen key code 209001.

Code

209000

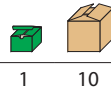

209

tech. broch. 01140

Special allen key for tamper-proof anti-theft cap. To be used with tamperproof cap 209 series.

Code

209001

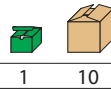

For other CALEFFI CODE® components, refer to page 95

CALEFFI CODE® connected thermal regulation system

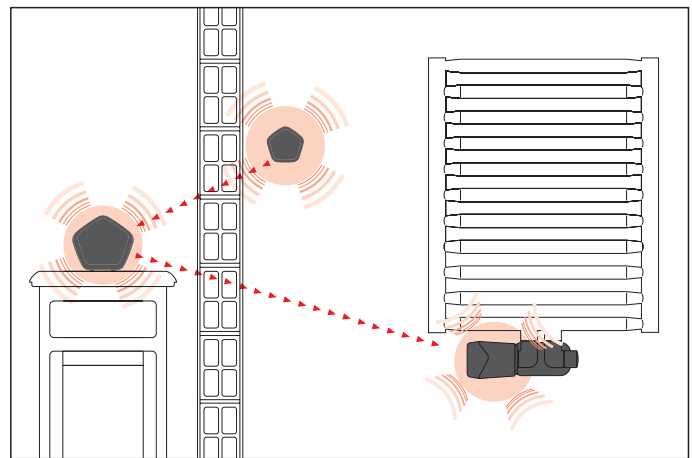

Example of HIGH-STYLE valve installation for designer heating systems, right-hand version, with thermostatic control head



Example of HIGH-STYLE valve installation for designer heating systems with central connection, left-hand version, with electronic control.



HIGH-STYLE CONVERTIBLE RADIATOR VALVES

4001

tech. broch. 01140



- Pair consisting of:
- angled-convertible radiator valve fitted for thermostatic control head code 200015;
  - angled lockshield valve;
  - two pipe-covering/wall-covering shells and allen key.

To be used with fittings 437, 447, 681 and 679 series.

High chrome finish.

Max. working pressure: 10 bar.  
Temperature range: 5–100 °C.



Code	Radiator connection	Pipe connection	Kv (m³/h) valve	Kv (m³/h) lockshield valve (f.o.)		
400100	1/2"	23 p.1,5	2,0	1,92	1	5

4003

tech. broch. 01140

- Pair consisting of:
- double-angled convertible radiator valve fitted for thermostatic control head code 200015;
  - lockshield valve, double-angled connections;
  - two pipe-covering/wall-covering shells and allen key.



Right-hand version.

To be used with fittings 437, 447, 681 and 679 series.

High chrome finish.

Max. working pressure: 10 bar.  
Temperature range: 5–100 °C.



Code	Radiator connection	Pipe connection	Kv (m³/h) valve	Kv (m³/h) lockshield valve (f.o.)		
400300	1/2"	23 p.1,5	1,27	1,37	1	5

4004

tech. broch. 01140

- Pair consisting of:
- double-angled convertible radiator valve fitted for thermostatic control head code 200015;
  - lockshield valve, double-angled connections;
  - two pipe-covering/wall-covering shells and allen key.



Left-hand version.

To be used with fittings 437, 447, 681 and 679 series.

High chrome finish.

Max. working pressure: 10 bar.  
Temperature range: 5–100 °C.



Code	Radiator connection	Pipe connection	Kv (m³/h) valve	Kv (m³/h) lockshield valve (f.o.)		
400400	1/2"	23 p.1,5	1,27	1,37	1	5

4003

tech. broch. 01140

- Pair consisting of:
- double-angled convertible radiator valve fitted for thermostatic control head code 200015;
  - lockshield valve, double-angled connections;
  - pipe-covering/wall-covering shell, connections: 50 mm centre distance.

Central connections.



Right-hand version.

To be used with fittings 437, 447, 681 and 679 series.



High chrome finish.

Max. working pressure: 10 bar.  
Temperature range: 5–100 °C.

Code	Radiator connection	Pipe connection	Kv (m³/h) valve	Kv (m³/h) lockshield valve (f.o.)		
400310	1/2"	23 p.1,5	1,27	1,37	1	5

4004

tech. broch. 01140

- Pair consisting of:
- double-angled convertible radiator valve fitted for thermostatic control head code 200015;
  - lockshield valve, double-angled connections;
  - pipe-covering/wall-covering shell, connections: 50 mm centre distance.

Central connections.



Left-hand version.

To be used with fittings 437, 447, 681 and 679 series.



High chrome finish.

Max. working pressure: 10 bar.  
Temperature range: 5–100 °C.

Code	Radiator connection	Pipe connection	Kv (m³/h) valve	Kv (m³/h) lockshield valve (f.o.)		
400410	1/2"	23 p.1,5	1,27	1,37	1	5

Example of HIGH-STYLE valve installation for designer heating systems, right-hand version, with thermostatic control head

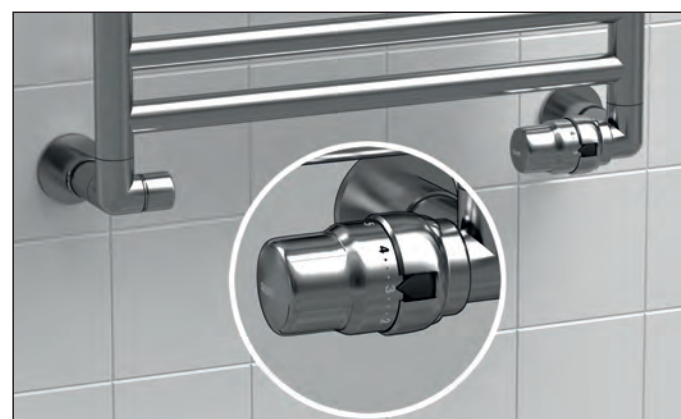

## HIGH-STYLE CONVERTIBLE RADIATOR VALVES

### 200

tech. broch. 01140



Thermostatic control head for designer heating system valves. Built-in sensor with liquid-filled element. For valves 4001, 4003, 4004 and 3380 series.  
**High chrome finish.** Graduated scale from \* to 5 corresponding to a temperature adjustment range from 7 °C to 28 °C. With adapter, tamper-proof cap and special key for tamper-proof cap.

Code

200015



1 5

### 200

tech. broch. 01140



Thermostatic control head for designer heating system valves. Built-in sensor with liquid-filled element. For valves 4001, 4003, 4004 and 3380 series.  
**High chrome finish.** Graduated scale from \* to 5 corresponding to a temperature adjustment range from 7 °C to 28 °C. With adapter.

Code

200013



1 10

### 209

tech. broch. 01140



Tamper-proof anti-theft cap for use in public places. For thermostatic control heads 200 series.  
**High chrome finish.** To be used with special allen key code 209001.

Code

209004



1 10

### 209

tech. broch. 01140



Special allen key for tamper-proof anti-theft cap. To be used with tamperproof cap 209 series.

Code

209001



1 10

Example of HIGH-STYLE valve installation for designer heating systems with central connection, left-hand version, with thermostatic control head



## CONVERTIBLE RADIATOR VALVES

### 3380



Pair consisting of:  
- convertible radiator valve fitted for thermo-electric actuators and thermostatic control heads;  
- lockshield valve.

Angled connections.  
**High chrome finish.**  
Max. working pressure: 10 bar.  
Temperature range: 5–100 °C.

Code	Radiator connection	Pipe connection	Kv (m³/h) valve	Kv (m³/h) lockshield valve (f.o.)		
338040	1/2" M	23 p.1,5	2,70	3,99	1	5

### 437



Compression fitting, for annealed copper, hard copper, brass, mild and stainless steel pipes. With O-Ring seal. **High chrome finish.**  
Max. working pressure: 10 bar.  
Temperature range : -25–120 °C.

Code

437112	23 p.1,5 - Ø 12	1	50
437114	23 p.1,5 - Ø 14	1	50
437115	23 p.1,5 - Ø 15	1	50
437116	23 p.1,5 - Ø 16	1	50

### 681 DARGAL



Self-adjustable diameter fitting for single and multilayer plastic pipes.  
**High chrome finish.**  
Max. working pressure: 10 bar.  
Temperature range:  
5–80 °C (PE-X)  
5–75 °C (Multilayer marked 95 °C).

Code		Ø <sub>inside</sub>	Ø <sub>outside</sub>		
681101	23 p.1,5	9,5–10	12–14	1	50
681124	23 p.1,5	11,5–12	14–16	1	50

### 383



Fitting for conversion from copper to steel connection.

Code

383231	23 p.1,5 F x 3/8" F	1	10
383241	23 p.1,5 F x 1/2" F	1	10

## CONVERTIBLE RADIATOR AND LOCKSHIELD VALVES WITH PUSH FIT CONNECTION



### 338

Angled convertible radiator valve fitted for thermostatic control head and thermo-electric actuators. Chrome plated. Push fit connection for Ø 15 hard and annealed copper pipes or for extension code 936415. Max. working pressure: 10 bar. Temperature range: 5–100 °C.

Code	Radiator connection	Pipe connection	Kv (m <sup>3</sup> /h)		
338415	1/2"	Ø 15	2,70	1	50



### 342

Angled lockshield valve. Chrome plated. Push fit connection for Ø 15 hard and annealed copper pipes or for extension code 936415. Max. working pressure: 10 bar. Temperature range: 5–100 °C.

Code	Radiator connection	Pipe connection	Kv (m <sup>3</sup> /h) fully open		
342415	1/2"	Ø 15	3,99	1	50

#### Installation of the valve on the pipe and locking with suitable clamps

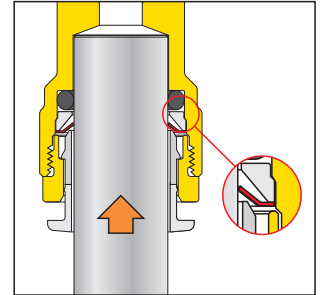
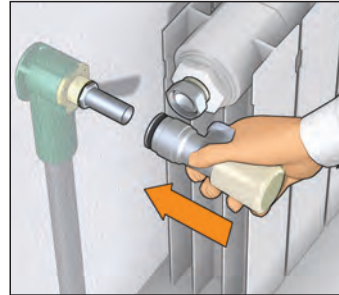

#### Release by pressing on the outer ring

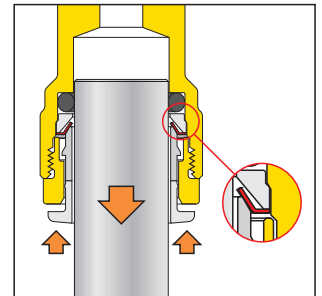
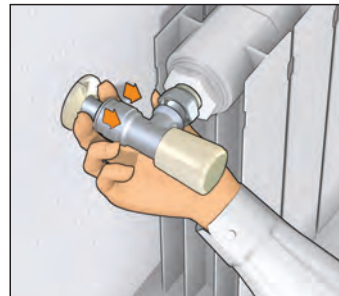

## WALL-COVERING PLATES



### 4499

Single wall-covering plate. White colour RAL 9010. For pipes with external diameter from 12 to 20 mm.

Code		
449900	–	40



### 4499

Single wall-covering plate. Chrome plated. For pipes with external diameter from 12 to 20 mm.

Code		
449910	1	40



### 4499

Double wall-covering plate. White colour RAL 9010. For pipes with external diameter from 12 to 20 mm.

Code	Outlet centre distance		
449901	35 mm	1	50
449902	40 mm	1	50



### 4499

Double wall-covering plate. Chrome plated. For pipes with external diameter from 12 to 20 mm.

Code	Outlet centre distance		
449911	35 mm	1	50
449912	40 mm	1	50

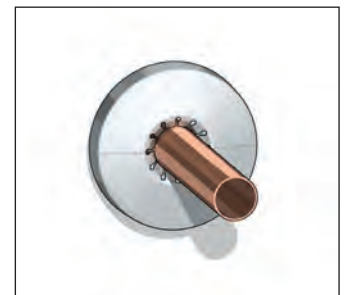
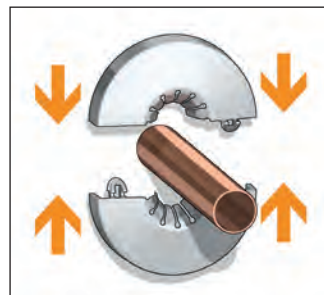



THERMO-ELECTRIC ACTUATORS

6563

tech. broch. 01142



Thermo-electric actuator. With manual opening and position indicator. For valves 338, 339, 401, 402, 425, 426, 421, 422, 230, 231, 232, 233, 234, 237, 220, 221, 222, 223, 224, 225, 226, 227, 455 and 456 series. Normally closed. **With auxiliary microswitch.** Supply: 230 V (AC) or 24 V (AC)/(DC). Power consumption: 3 W. Starting current: ≤ 1 A. Starting current (656344/54): ≤ 250 mA. Auxiliary microswitch contact rating: 0,8 A (230 V). Ambient temperature range: 0–50 °C. Protection class: IP 40. Cable length: 80 cm. PATENT.



Code	Supply voltage V			
656312	230		1	10
656314	24		1	10
656302	230	without auxiliary microswitch	1	10
656304	24	without auxiliary microswitch	1	10

With low power consumption

Code	Supply voltage V			
656354	24		1	10
656344	24	without auxiliary microswitch	1	10

6561

tech. broch. 01042



Thermo-electric actuator. For valves 338, 339, 401, 402, 425, 426, 421, 422, 230, 231, 232, 233, 234, 237, 220, 221, 222, 223, 224, 225, 226, 227, 455 and 456 series. Normally closed. **With auxiliary microswitch.** Supply: 230 V (AC) or 24 V (AC)/(DC). Auxiliary microswitch contact rating: 0,8 A (230 V). Power consumption: 3 W. Starting current: ≤ 1 A. Ambient temperature range: 0–50 °C. Protection class: IP 44 (vertical stem). Cable length: 80 cm.



Code	Supply voltage V			
656112	230		1	10
656114	24		1	10
656102	230	without auxiliary microswitch	1	10
656104	24	without auxiliary microswitch	1	10

6562

tech. broch. 01198



Thermo-electric actuator. With opening position indicator. **Quick-coupling installation, with a clip adapter.** For valves 338, 339, 401, 402, 425, 426, 421, 422, 230, 231, 232, 233, 234, 237, 220, 221, 222, 223, 224, 225, 226, 227, 455 and 456 series. Normally closed. **With auxiliary microswitch.** Supply: 230 V (AC) or 24 V (AC)/(DC). Auxiliary microswitch contact rating: 0,8 A (230 V). Power consumption: 3 W. Starting current: ≤ 1 A. Ambient temperature range: 0–50 °C. Protection class: IP 54. Cable length: 80 cm.

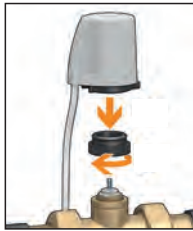

Code	Supply voltage V			
656212	230		1	10
656214	24		1	10
656202	230	without auxiliary microswitch	1	10
656204	24	without auxiliary microswitch	1	10

6564

tech. broch. 01198



Thermo-electric actuator with low power consumption. With opening position indicator. **Quick-coupling installation, with a clip adapter.** For valves 338, 339, 401, 402, 425, 426, 421, 422, 230, 231, 232, 233, 234, 237, 220, 221, 222, 223, 224, 225, 226, 227, 455 and 456 series. Normally closed. **With auxiliary microswitch.** Supply: 230 V (AC) or 24 V (AC)/(DC). Auxiliary microswitch contact rating: 0,8 A (230 V). Power consumption: 3 W. Starting current: ≤ 250 mA. Ambient temperature range: 0–50 °C. Protection class: IP 54. Cable length: 80 cm.



Code	Supply voltage V			
656412	230		1	10
656414	24		1	10
656402	230	without auxiliary microswitch	1	10
656404	24	without auxiliary microswitch	1	10



Adapter for installing thermostatic and thermo-electric actuator with valves 338, 339, 401, 402, 425, 426, 421, 422, 455 and 456 series.

Code			
F36077		1	50

MANUAL RADIATOR AND LOCKSHIELD VALVES



340

tech. broch. 01030

Angled manual radiator valve.  
Chrome plated.  
For copper, single and multilayer plastic pipes.  
Max. working pressure: 10 bar.  
Temperature range: 5–100 °C.

Code	Radiator connection	Pipe connection	Kv (m <sup>3</sup> /h)		
340302	3/8"	23 p.1,5	2,42	10	50
340402	1/2"	23 p.1,5	3,99	10	50
340452	1/2"	3/4"	3,99	10	50



342

tech. broch. 01030

Angled lockshield valve.  
Chrome plated.  
For copper, single and multilayer plastic pipes.  
Max. working pressure: 10 bar.  
Temperature range: 5–100 °C.

Code	Radiator connection	Pipe connection	Kv (m <sup>3</sup> /h) fully open		
342302	3/8"	23 p.1,5	2,42	10	50
342402	1/2"	23 p.1,5	3,99	10	50
342452	1/2"	3/4"	3,99	10	50



341

tech. broch. 01030

Straight manual radiator valve.  
Chrome plated.  
For copper, single and multilayer plastic pipes.  
Max. working pressure: 10 bar.  
Temperature range: 5–100 °C.

Code	Radiator connection	Pipe connection	Kv (m <sup>3</sup> /h)		
341302	3/8"	23 p.1,5	1,32	10	50
341402	1/2"	23 p.1,5	2,17	10	50



343

tech. broch. 01030

Straight lockshield valve.  
Chrome plated.  
For copper, single and multilayer plastic pipes.  
Max. working pressure: 10 bar.  
Temperature range: 5–100 °C.

Code	Radiator connection	Pipe connection	Kv (m <sup>3</sup> /h) fully open		
343302	3/8"	23 p.1,5	1,32	10	50
343402	1/2"	23 p.1,5	2,17	10	50



411

tech. broch. 01030

Angled manual radiator valve.  
Chrome plated.  
For steel pipe.  
Max. working pressure: 10 bar.  
Temperature range: 5–100 °C.

Code	Radiator connection	Pipe connection	Kv (m <sup>3</sup> /h)		
411302	3/8"		2,42	10	50
411402	1/2"		3,99	10	50
411422*	1/2"		3,99	10	50
401500**	3/4"	without rubber seal	3,36	5	25
401603**	1"	without rubber seal	4,47	5	25

\* with chrome plated knob  
\*\* convertible radiator valve



431

tech. broch. 01030

Angled lockshield valve.  
Chrome plated.  
For steel pipe.  
Max. working pressure: 10 bar.  
Temperature range: 5–100 °C.

Code	Radiator connection	Pipe connection	Kv (m <sup>3</sup> /h) fully open		
431302	3/8"		2,42	10	50
431402	1/2"		3,99	10	50
431422*	1/2"		3,99	10	50
431503	3/4"	without rubber seal	4,52	5	25
431603	1"	without rubber seal	5,64	5	25

\* with chrome plated knob



412

tech. broch. 01030

Straight manual radiator valve.  
Chrome plated.  
For steel pipe.  
Max. working pressure: 10 bar.  
Temperature range: 5–100 °C.

Code	Radiator connection	Pipe connection	Kv (m <sup>3</sup> /h)		
412302	3/8"		1,32	10	50
412402	1/2"		2,17	10	50
412422*	1/2"		2,17	10	50
412503	3/4"	without rubber seal	2,58	5	25
402603**	1"	without rubber seal	4,43	5	25

\* with chrome plated knob  
\*\* convertible radiator valve



432

tech. broch. 01030

Straight lockshield valve.  
Chrome plated.  
For steel pipe.  
Max. working pressure: 10 bar.  
Temperature range: 5–100 °C.

Code	Radiator connection	Pipe connection	Kv (m <sup>3</sup> /h) fully open		
432302	3/8"		1,32	10	50
432402	1/2"		2,17	10	50
432422*	1/2"		2,17	10	50
432503	3/4"	without rubber seal	2,58	5	25
432603	1"	without rubber seal	4,81	5	25

\* with chrome plated knob

ONE-PIPE AND TWO-PIPE RADIATOR VALVES FOR DESIGNER HEATING SYSTEMS

4005



Convertible radiator valve fitted for thermostatic and electronic control heads, thermo-electric actuators.

**High chrome finish.**

Factory set for one-pipe systems, adjustable for two-pipe systems.

**Right-hand version.**

For copper, single and multilayer plastic pipes.

Flow rate to the radiator:

- with manual control knob: 45 %
- with thermostic control head (proportional band 2K): 30 %

Outlet centre distance: 40 mm.

Brass probe: 40 cm.

Max. working pressure: 10 bar.

Temperature range: 5–100 °C.

Code	Radiator connection	Pipe connection	Kv (m <sup>3</sup> /h)			
			one-pipe	two-pipe		
400510	1/2"	23 p.1,5	1,6	0,96	1	5

One-pipe application

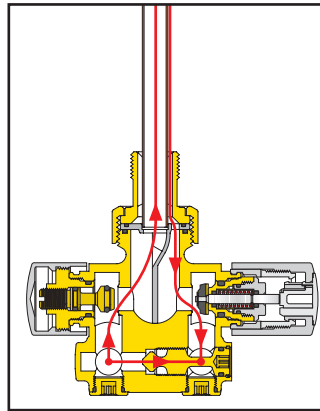

Two-pipe application

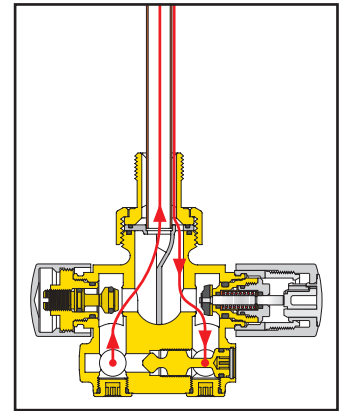

Flow and return connections can be inverted by means of the rotation of the specific deflector.

4005



Convertible radiator valve fitted for thermostatic and electronic control heads, thermo-electric actuators.

**High chrome finish.**

Factory set for one-pipe systems, adjustable for two-pipe systems.

**Left-hand version.**

For copper, single and multilayer plastic pipes.

Flow rate to the radiator:

- with manual control knob: 45 %
- with thermostic control head (proportional band 2K): 30 %

Outlet centre distance: 40 mm.

Brass probe: 40 cm.

Max. working pressure: 10 bar.

Temperature range: 5–100 °C.

Code	Radiator connection	Pipe connection	Kv (m <sup>3</sup> /h)			
			one-pipe	two-pipe		
400520	1/2"	23 p.1,5	1,6	0,96	1	5

Installation example of the designer heating system radiator valve, vertical probe, left-hand version, with thermostatic control head



## ONE-PIPE AND TWO-PIPE RADIATOR VALVES

### 455

tech. broch. 01051

Convertible radiator valve fitted for thermostatic control heads and thermo-electric actuator.  
Chrome plated.

Factory set for one-pipe systems, adjustable for two-pipe systems.

For copper, single and multilayer plastic pipes.

Outlet centre distance: 40 mm.

Brass probe: 30 cm.

Max. working pressure: 10 bar.

Temperature range: 5–100 °C.

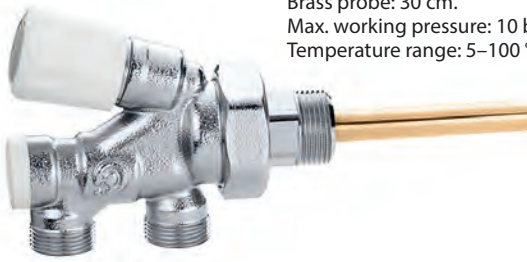

Code	Radiator connection	Pipe connection	Kv (m <sup>3</sup> /h)		Green box	Brown box
			one-pipe	two-pipe		
455400	1/2"	23 p.1,5	2,00	1,10	10	–
455500	3/4"	23 p.1,5	2,00	1,10	10	–
455600	1" right	23 p.1,5	2,00	1,10	10	–
455601	1" left	23 p.1,5	2,00	1,10	10	–

### Conversion of valve from one-pipe to two-pipe mode

The valve is converted from one-pipe to two-pipe mode by shutting off the by-pass (1) on the mobile sleeve (2) located above the outlet connections (3).

The valve is provided preconfigured for one-pipe function, e.g. with the sleeve (2) in the forward position and the by-pass (1) open. To convert the valve from the one-pipe factory configuration to the two-pipe configuration, remove the plastic cap (4) and fully unscrew the sleeve (2) to the withdrawn position, by turning the outermost 10 mm hexagonal head screw. To revert to the one-pipe configuration, carry out the procedure in reverse order, fully screwing down the sleeve to the forward position.

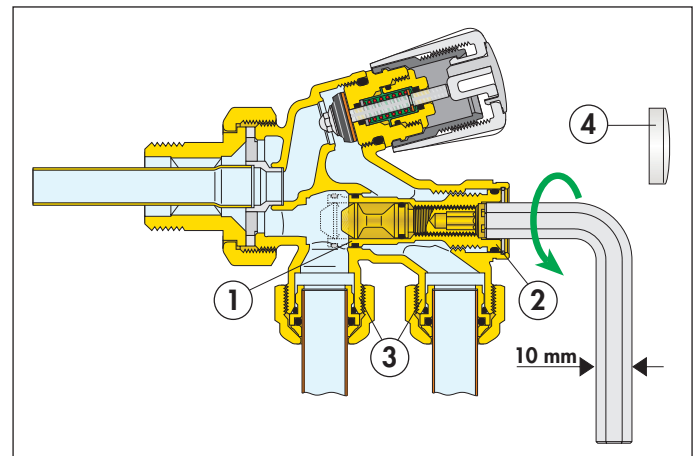

### One-pipe application

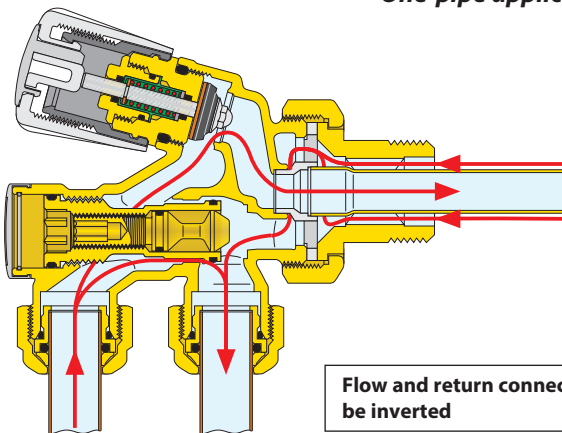

### Two-pipe application

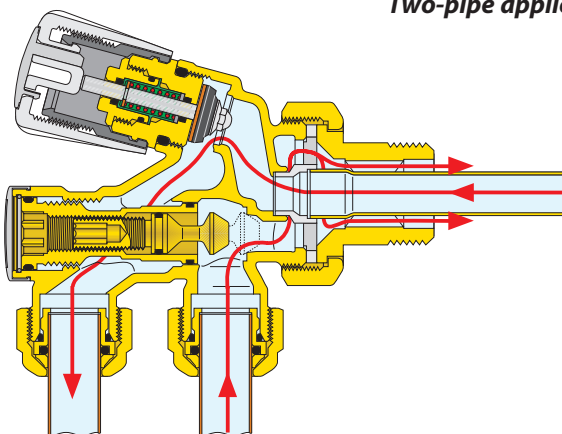

## SPARE PARTS

Tailpiece with probe for 455 series one-pipe convertible radiator valve.



Code

R49158 1/2" - Ø 11

R49159 3/4" - Ø 11

R49160 1" D - Ø 14

R49161 1" S - Ø 14

Nut for 455 series one-pipe convertible radiator valve union.



Code

R41277/C 1/2" - 3/4" - 1"

Jet breaker for 348 and 455 series one-pipe valve.



Code

R46030 for 348 series

R46042 for 455 series (previous version)

Jet breaker for 455 series one-pipe convertible radiator valve.



Code

R46072

VALVES FOR ONE-PIPE SYSTEMS

456

tech. broch. 01323

Convertible radiator valve fitted for thermostatic and electronic control heads, thermo-electric actuators.

For one-pipe systems.

For copper, single and multilayer plastic pipes.

Flow rate to the radiator:

- with manual control knob: 27 %,

- with thermostatic control head (proportional band 2K): 20 %.



Outlet centre distance: 35 mm.

PP probe: 33 cm.

Max. working pressure: 10 bar.

Temperature range: 5–100 °C.



Code	Radiator connection	Pipe connection	Kv (m³/h)		
456400	1/2"	23 p.1,5	1,6	10	–
456500	3/4"	23 p.1,5	1,6	10	–

4501

Radiator valve for one-pipe systems.

Chrome plated.

For copper, single and multilayer plastic pipes.

Flow rate to the radiator: 100 %.

Without template and wall-covering plate.



Outlet centre distance: 40 mm.

Brass probe: 30 cm.

Max. working pressure: 10 bar.

Max. working temperature: 100 °C.



Code	Radiator connection	Pipe connection	Kv (m³/h)		
450140	1/2"	23 p.1,5	3,20	10	40
450150	3/4"	23 p.1,5	3,70	10	–

348

Radiator valve for one-pipe systems.

Chrome plated.

For copper, single and multilayer plastic pipes.

Flow rate to the radiator: 100 %.

With front adjusting handle.

Without template and wall-covering plate.



Outlet centre distance: 40 mm.

Brass probe: 30 cm.

Max. working pressure: 10 bar.

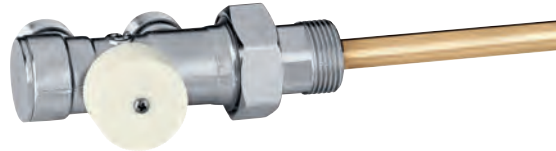
Max. working temperature: 100 °C.



Code	Radiator connection	Pipe connection	Kv (m³/h)		
348400	1/2"	23 p.1,5	3,10	10	–
348500	3/4"	23 p.1,5	3,50	10	–

452

Radiator valve for one-pipe systems.

Chrome plated.

For copper, single and multilayer plastic pipes.

Flow rate to the radiator: 50 %.

For Ø 15 mm outside probe (454 series).

Wall connections.



Complete with template, wall-covering plate and probe connection.

Outlet centre distance: 40 mm.

Max. working pressure: 10 bar.

Max. working temperature: 100 °C.



Code	Radiator connection	Pipe connection	Kv (m³/h)		
452400	1/2"	23 p.1,5	2,20	1	25

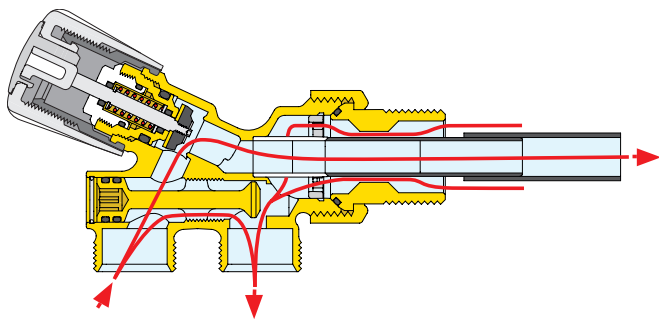

Flow and return connections can be inverted

**ONE-PIPE AND TWO-PIPE RADIATOR VALVES AND ACCESSORIES**

**452**

Radiator valve for two-pipe systems.  
 Chrome plated.  
 For copper, single and multilayer plastic pipes.  
 For Ø 15 mm outside probe (454 series).  
 Wall connections.  
 Complete with template, wall-covering plate and probe connection.  
 Outlet centre distance: 40 mm.  
 Max. working pressure: 10 bar.  
 Max. working temperature: 100 °C.



Code	Radiator connection	Pipe connection	Kv (m³/h)		
452401	1/2"	23 p.1,5	1,80	1	25

**328**

Radiator valve for one-pipe systems.  
 Chrome plated.  
 For copper, single and multilayer plastic pipes.  
 Flow rate to the radiator: 50 %.  
 For Ø 15 mm outside probe (454 series).  
 Floor connections.  
 Complete with probe connection.  
 Outlet centre distance: 40 mm.  
 Max. working pressure: 10 bar.  
 Max. working temperature: 100 °C.



Code	Radiator connection	Pipe connection	Kv (m³/h)		
328400	1/2"	23 p.1,5	2,20	1	20

**328**

Radiator valve for two-pipe systems.  
 Chrome plated.  
 For copper, single and multilayer plastic pipes.  
 For Ø 15 mm outside probe (454 series).  
 Floor connections.  
 Complete with probe connection.  
 Outlet centre distance: 40 mm.  
 Max. working pressure: 10 bar.  
 Max. working temperature: 100 °C.



Code	Radiator connection	Pipe connection	Kv (m³/h)		
328401	1/2"	23 p.1,5	1,80	1	20

**459**



Angled connection for one-pipe valves 328 and 452 series and convertible radiator valves code 339402.  
 Chrome plated.

Code			
459001	1/2" M x 3/4" F nut	10	-

**4496**



Wall template.  
 For valves 4501, 452, 328, 348 and 455 series.  
 Outlet centre distance: 40 mm.

Code			
449640		10	-

**453**



Brass pipe extension for probe.  
 For valves 348, 4501 and 455 series.

Code			
453020	200 mm (x 348-4501-455400-455500)	10	-
453030	300 mm (x 455600-455601)	10	-

**454**

Ø 15 mm brass outside probe. Chrome plated.  
 To be connected with valves 452 and 328 series at the bottom and radiator valves 223, 227, 339 and 341 series.



Code			
454060	600 mm	5	-
454090	900 mm	5	-

ACCESSORIES

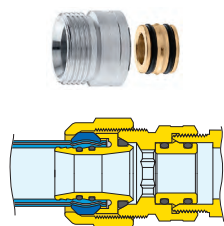

**383**  
Connection fitting with O-Ring seal for use with 3/4" 679 and 681 series. Chrome plated.

Code			
<b>383551</b>	3/4" M x 23 p.1,5 F	10	100



**382**  
Reduced tailpiece. Chrome plated.

Code			
<b>382532</b>	3/4" F nut x 3/8" M	1	-



**381**  
Telescopic union tailpiece with nut for radiator valves and lockshield valves. Extension range: 15 mm. Max. working pressure: 10 bar. Max. working temperature: 100 °C. Chrome plated.

Code			
<b>381302</b>	1/2" F nut x 3/8" M	1	10
<b>381402</b>	3/4" F nut x 1/2" M	1	10



**383**  
Female fitting - olive coupling. Chrome plated.

Code			
<b>383151</b>	3/4" M x 23 p.1,5 F	10	-



**384**  
Male fitting - olive coupling. Chrome plated.

Code			
<b>384031</b>	3/8" M x 23 p.1,5 M	10	-
<b>384041</b>	1/2" M x 23 p.1,5 M	10	-



**382**  
Fitting with 23 p.1,5 captive nut. Chrome plated. Max. working pressure: 10 bar. Max. working temperature: 100 °C.

Code			
<b>382000</b>	23 p.1,5 M x 23 p.1,5 F nut	10	-



**942**  
Sleeve. Chrome plated.

Code			
<b>942551</b>	3/4" M x 3/4"	1	-
<b>942561</b>	3/4" M x 1"	1	-



**936**  
Extension for connection between elbow fitting 933 series and radiator valves. Annealed copper, chrome plated. With shaped rubber seal. Length: 200 mm (useful 188 mm).

Code			
<b>936400</b>	1/2" x Ø 16	1	50

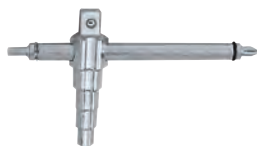

**3871**  
Universal key. Use for 3/8" to 1" union tailpiece.

Code			
<b>387127</b>		1	10



**3871**  
Wrench for 26 and 30 mm hexagonal nuts. For fittings 437, 447, 679, 680, 681 23 p.1,5 and 3/4" series.

Code			
<b>387100</b>		1	4



**560**  
Drain cock for radiators and wall-mounted boilers. Max. working pressure: 10 bar. Max. working temperature: 100 °C. Chrome plated.

tech. broch. 01056

Code			
<b>560421</b> ♦	1/2"	10	-
<b>560000</b>	extractor hose connection	25	-

♦ One extractor hose connection code 560000 is included in each 10-item package.

FITTINGS 23 p.1,5



**679**  
**DARCAL**

Fitting for multilayer plastic pipes for continuous high temperature use. Max. working pressure: 10 bar. Temperature range: 0-95 °C. Chrome plated.

For a correct use, adjust the multilayer pipe diameter before installation using the Caleffi calibrator 679 series (see page 111).

Code				
679014	23 p.1,5 - Ø 14x2	10	100	
679024	23 p.1,5 - Ø 16x2	10	100	
679025	23 p.1,5 - Ø 16x2,25	10	100	
679044	23 p.1,5 - Ø 18x2	10	100	
679064*	23 p.1,5 - Ø 20x2	10	100	
679065*	23 p.1,5 - Ø 20x2,25	10	100	
679066*	23 p.1,5 - Ø 20x2,5	10	100	
679067*	23 p.1,5 - Ø 20x2,9 (REHAU pipe)	10	100	

\* With metal ring

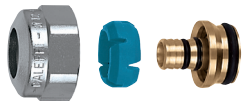

**681**  
**DARCAL**

Self-adjustable diameter fitting for single and multilayer plastic pipes. Max. working pressure: 10 bar. Temperature range: 5-80 °C (PE-X) 5-75 °C (Multilayer marked 95 °C). Chrome plated.

Code		Ø <sub>inside</sub>	Ø <sub>outside</sub>		
681000	23 p.1,5	7,5- 8	12-14	10	100
681002	23 p.1,5	9 - 9,5	14-16	10	100
681001	23 p.1,5	9,5-10	12-14	10	100
681006	23 p.1,5	9,5-10	14-16	10	100
681015	23 p.1,5	10,5-11	14-16	10	100
681017	23 p.1,5	10,5-11	16-18	10	100
681024	23 p.1,5	11,5-12	14-16	10	100
681026	23 p.1,5	11,5-12	16-18	10	100
681035	23 p.1,5	12,5-13	16-18	10	100
681044	23 p.1,5	13,5-14	16-18	10	100

Example: 681 series fitting selection

Known both the outside and inside diameters (ex.: 17 mm and 13 mm); or known the outside diameter (ex.: Ø<sub>o</sub> 17 mm) and the thickness (ex.: th. 2 mm) and considering that:

$$\text{Ø}_{\text{outside}} - 2 \cdot \text{th.} = \text{Ø}_{\text{inside}}$$

$$17 - 2 \cdot 2 = 13 \text{ mm}$$

Look within the table for the code matching both diameters:

Code		Ø <sub>inside</sub>	Ø <sub>outside</sub>
681035	23 p.1,5	12,5-13	16-18



**447**

Pre-assembled compression fitting, for soft annealed copper, hard copper, brass, mild and stainless steel pipes. With O-Ring seal. Max. working pressure: 10 bar. Temperature range: -25-120 °C. Chrome plated.

Code			
447010	23 p.1,5 - Ø 10	100	-
447012	23 p.1,5 - Ø 12	100	-
447014	23 p.1,5 - Ø 14	100	-
447015	23 p.1,5 - Ø 15	100	-
447016	23 p.1,5 - Ø 16	100	-



**437**

Compression fitting, for soft annealed copper, hard copper, brass, mild and stainless steel pipes. With O-Ring seal. Max. working pressure: 10 bar. Temperature range: -25-120 °C. Chrome plated.

Code			
437010	23 p.1,5 - Ø 10	100	-
437012	23 p.1,5 - Ø 12	100	-
437014	23 p.1,5 - Ø 14	100	-
437015	23 p.1,5 - Ø 15	100	-
437016	23 p.1,5 - Ø 16	100	-



**439**

Fitting for copper pipe, with gasket. Chrome plated. **Do not use with valves 232 series.**

Code			
439010	23 p.1,5 - Ø 10	100	-
439012	23 p.1,5 - Ø 12	100	-
439014	23 p.1,5 - Ø 14	100	-
439015	23 p.1,5 - Ø 15	100	-
439016	23 p.1,5 - Ø 16	100	-



**438**

Compression fitting for copper pipe, with PTFE seal. Chrome plated.

Code			
438010	23 p.1,5 - Ø 10	100	-
438012	23 p.1,5 - Ø 12	100	-
438014	23 p.1,5 - Ø 14	100	-
438015	23 p.1,5 - Ø 15	100	-
438016	23 p.1,5 - Ø 16	100	-
438018	23 p.1,5 - Ø 18 with metal olive	100	-



FITTINGS 3/4"



**679**  
**DARGAL**

Fitting for multilayer plastic pipes for continuous high temperature use. Max. working pressure: 10 bar. Temperature range: 0–95 °C. Chrome plated.

**For a correct use, adjust the multilayer pipe diameter before installation using the Caleffi calibrator 679 series (see page 111).**

Code			
679264	3/4" - Ø 20x2	10	100
679265	3/4" - Ø 20x2,25	10	100
679266	3/4" - Ø 20x2,5	10	100

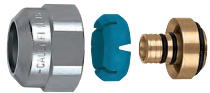

**681**  
**DARGAL**

Self-adjustable diameter fitting for single and multilayer plastic pipes. Max. working pressure: 10 bar. Temperature range: 5–80 °C (PE-X) 5–75 °C (Multilayer marked 95 °C). Chrome plated.

Code		Ø <sub>inside</sub>	Ø <sub>outside</sub>		
681502	3/4"	7,5– 8	12–14	10	100
681500	3/4"	9 – 9,5	14–16	10	100
681501	3/4"	9,5–10	12–14	10	100
681506	3/4"	9,5–10	14–16	10	100
681515	3/4"	10,5–11	14–16	10	100
681517	3/4"	10,5–11	16–18	10	100
681524	3/4"	11,5–12	14–16	10	100
681526	3/4"	11,5–12	16–18	10	100
681535	3/4"	12,5–13	16–18	10	100
681537	3/4"	12,5–13	18–20	10	100
681546	3/4"	13,5–14	18–20	10	100
681555	3/4"	14,5–15	18–20	10	100
681556	3/4"	15 – 15,5	18–20	10	100
681564	3/4"	15,5–16	18–20	10	100



**437**

Compression fitting, for annealed copper, hard copper, brass, mild and stainless steel pipes. With O-Ring seal. Max. working pressure: 10 bar. Temperature range: -25–120 °C. Chrome plated. For connecting pipes to special valves for panel radiators.

Code			
437510	3/4" - Ø 10	100	–
437512	3/4" - Ø 12	100	–
437514	3/4" - Ø 14	100	–
437515	3/4" - Ø 15	100	–
437516	3/4" - Ø 16	100	–
437518	3/4" - Ø 18	10	–



**438**

Compression fitting for copper pipe, with PTFE seal. Chrome plated.

Code			
438512	3/4" - Ø 12	100	–
438514	3/4" - Ø 14	100	–
438515	3/4" - Ø 15	100	–
438516	3/4" - Ø 16	100	–
438518	3/4" - Ø 18	100	–

CALIBRATOR FOR MULTILAYER PIPES



**679**

Calibrator and handle to adjust multilayer pipes diameter before use with fittings 679 series.

Code			
679001	calibrator Ø 14x2	1	–
679002	calibrator Ø 16x2	1	–
679003	calibrator Ø 16x2,25	1	–
679004	calibrator Ø 18x2	1	–
679006	calibrator Ø 20x2	1	–
679007	calibrator Ø 20x2,25	1	–
679008	calibrator Ø 20x2,5	1	–
679009	handle for calibrator	1	–
679010	calibrator Ø 26x3	1	–

Multilayer pipe calibration and installation of fitting components 679 series

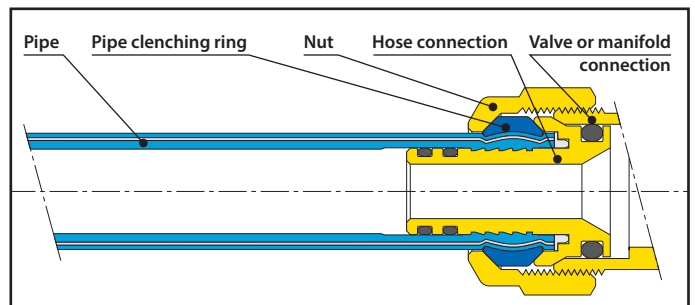
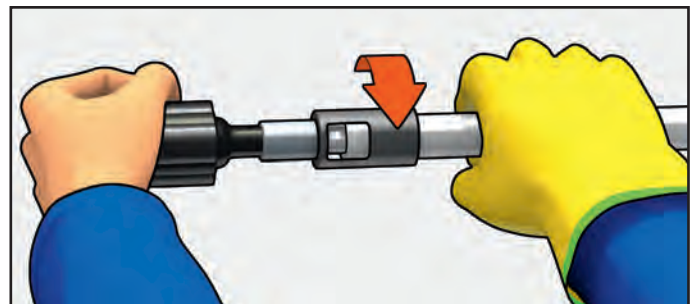

VALVES FOR PANEL RADIATORS

NEW

3010



Valve for panel radiators with built-in thermostatic valve unit. One-pipe straight version (floor connections). With adjustable by-pass. **With non-return device.** Max. working pressure: 10 bar. Max. working temperature: 100 °C.

Code	Radiator connection	Pipe connection		
301043	1/2" M	3/4"	1	25
301053	3/4" F	3/4"	1	25

3015



Angled single valve for panel radiators with built-in thermostatic valve unit (wall connections) with 1/2" F radiator connections. Max. working pressure: 10 bar. Max. working temperature: 100 °C.

Code	Radiator connection	Pipe connection		
301540	1/2" M	3/4"	1	50

NEW

3011



Valve for panel radiators with built-in thermostatic valve unit. One-pipe angled version (wall connections). With adjustable by-pass. **With non-return device.** Max. working pressure: 10 bar. Max. working temperature: 100 °C.

Code	Radiator connection	Pipe connection		
301143	1/2" M	3/4"	1	25
301153	3/4" F	3/4"	1	25

3015



Angled single valve for panel radiators with built-in thermostatic valve unit (wall connections) with 3/4" M radiator connections. Max. working pressure: 10 bar. Max. working temperature: 100 °C.

Code	Radiator connection	Pipe connection		
301550	3/4" F	3/4"	1	50

3012



Valve for panel radiators with built-in thermostatic valve unit. One-pipe straight version (floor connections). With adjustable by-pass. **With non-return device.** Max. working pressure: 10 bar. Max. working temperature: 100 °C.

Code	Radiator connection	Pipe connection		
301241	1/2" M	3/4"	1	25
301250	3/4" F	3/4"	1	25

3013



Valve for panel radiators with built-in thermostatic valve unit. One-pipe angled version (wall connections). With adjustable by-pass. **With non-return device.** Max. working pressure: 10 bar. Max. working temperature: 100 °C.

Code	Radiator connection	Pipe connection		
301341	1/2" M	3/4"	1	25
301350	3/4" F	3/4"	1	25

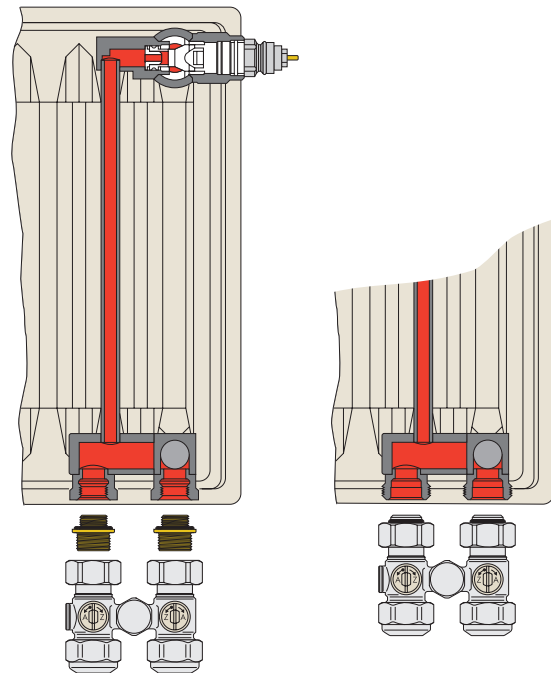

This valves are installed on a particular kind of panel radiators, featuring both the connections at the bottom and an inner pipe, invisible from outside, providing the flow medium to the upper valve.

They come in two versions: for two-pipe and one-pipe systems. Both are available straight (pipes exiting the floor) and angled (pipes exiting the wall). The two-pipe version is equipped with two ball shut-off valves; the one-pipe, in addition to the shut-off valves, is equipped with an adjustable by-pass from 30 % to 50 % of the flow rate towards the radiator.

# ZONE VALVES AND MOTORISED VALVES, DISTRIBUTION MANIFOLDS, WALL BOXES AND ACCESSORIES

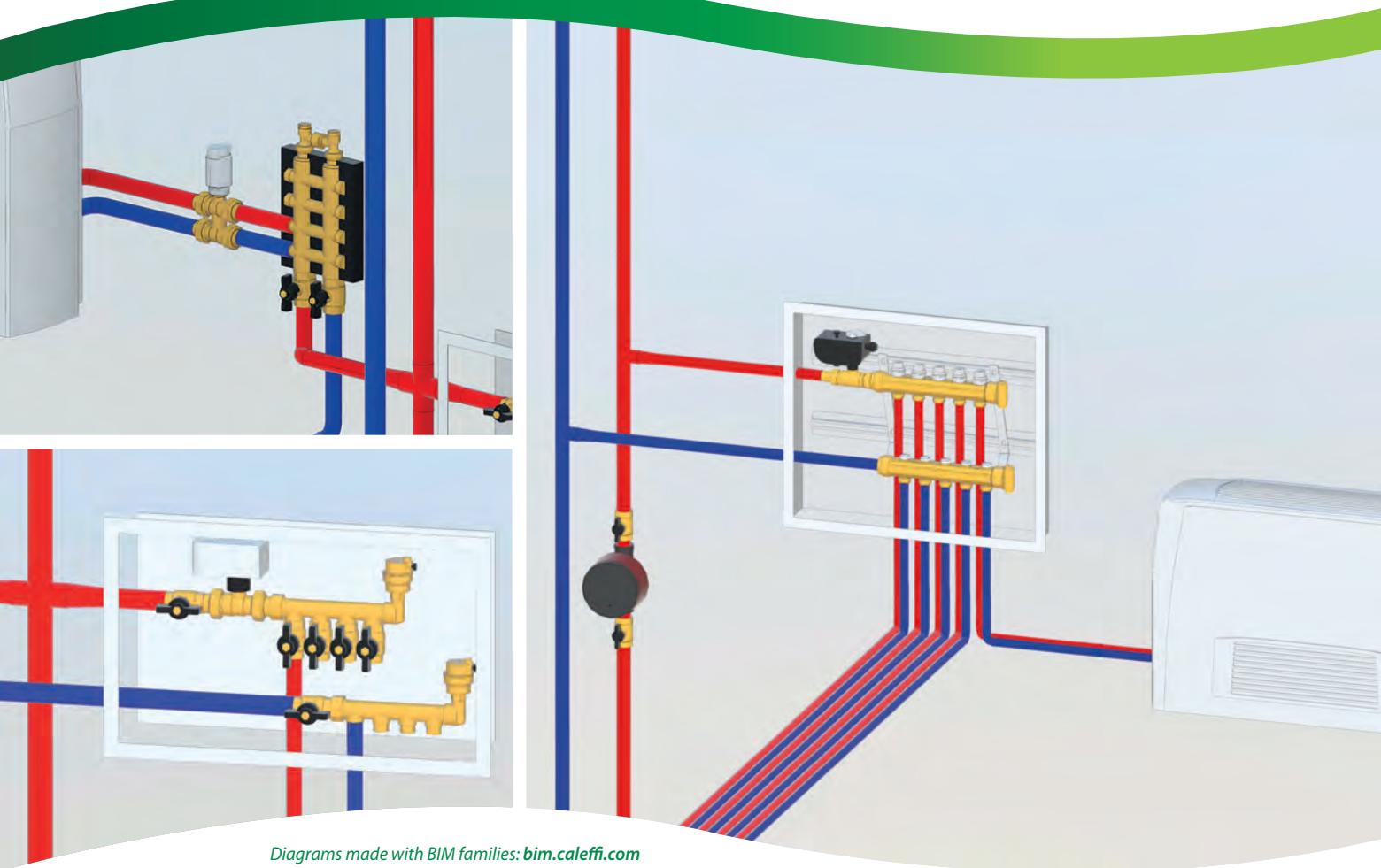

4

*Diagrams made with BIM families: [bim.caleffi.com](http://bim.caleffi.com)*

- Motorised ball zone valves**
- Thermo-electric zone piston valves**
- Motorised zone valves with spring return**
- Motorised ball valves**
- Motorised valves for central heating systems**
- Distribution manifolds**
- Thermo-electric actuators**
- Inspection wall boxes**

## TWO-WAY AND THREE-WAY VALVES, DISTRIBUTION MANIFOLDS AND BOXES

The zone valves perform the function of automatically shutting off the flow rate of the vector medium distributed to the system.

In particular:

- in zone heating systems, they assist in ambient temperature regulation;
- in domestic hot water production and storage systems they regulate the temperature inside storage boilers;
- in residential and industrial systems they shut off the medium in the distribution networks.

### Zone valves and motorised valves

- **Motorised ball zone valves**
- **Thermo-electric zone piston valves**
- **Motorised zone valves with spring return**
- **Motorised ball valves**
- **Motorised ball valves for high flow rates**
- **Motorised valves for central heating systems**
- **Butterfly valves**

### Distribution manifolds and boxes

- **Single manifolds**
- **Dual manifolds**
- **Manifolds with shut-off and pre-adjustment valves**
- **Thermo-electric actuators**
- **Fittings**
- **Plastic inspection wall boxes**
- **Sheet metal inspection wall boxes**

## ZONE VALVES AND MOTORISED VALVES

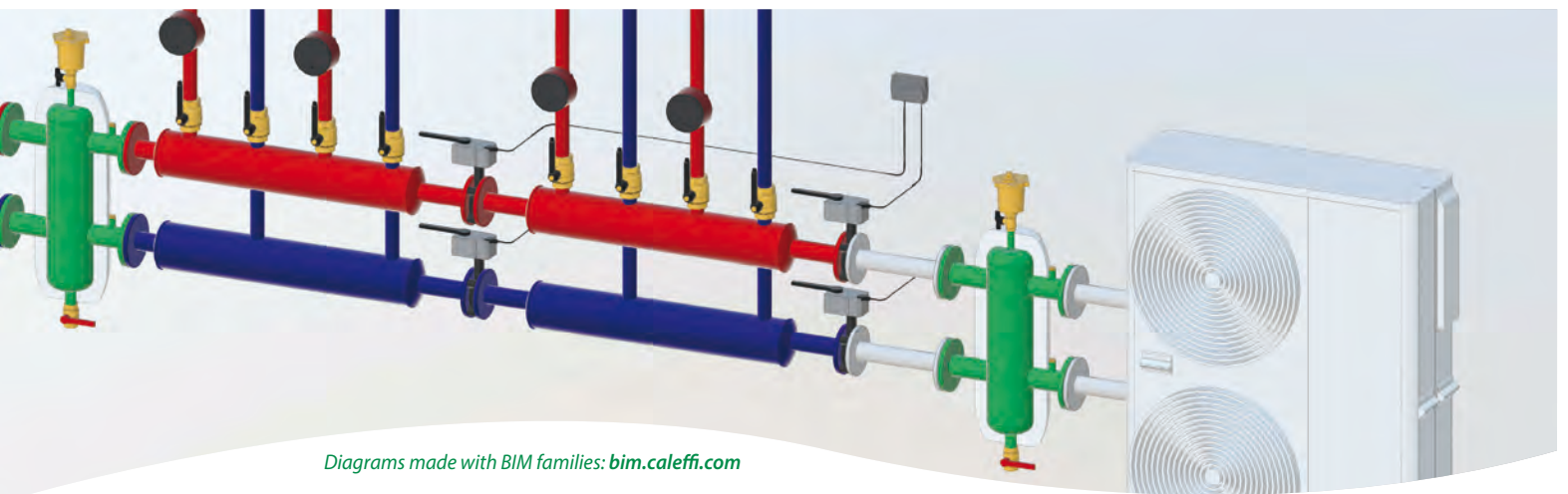
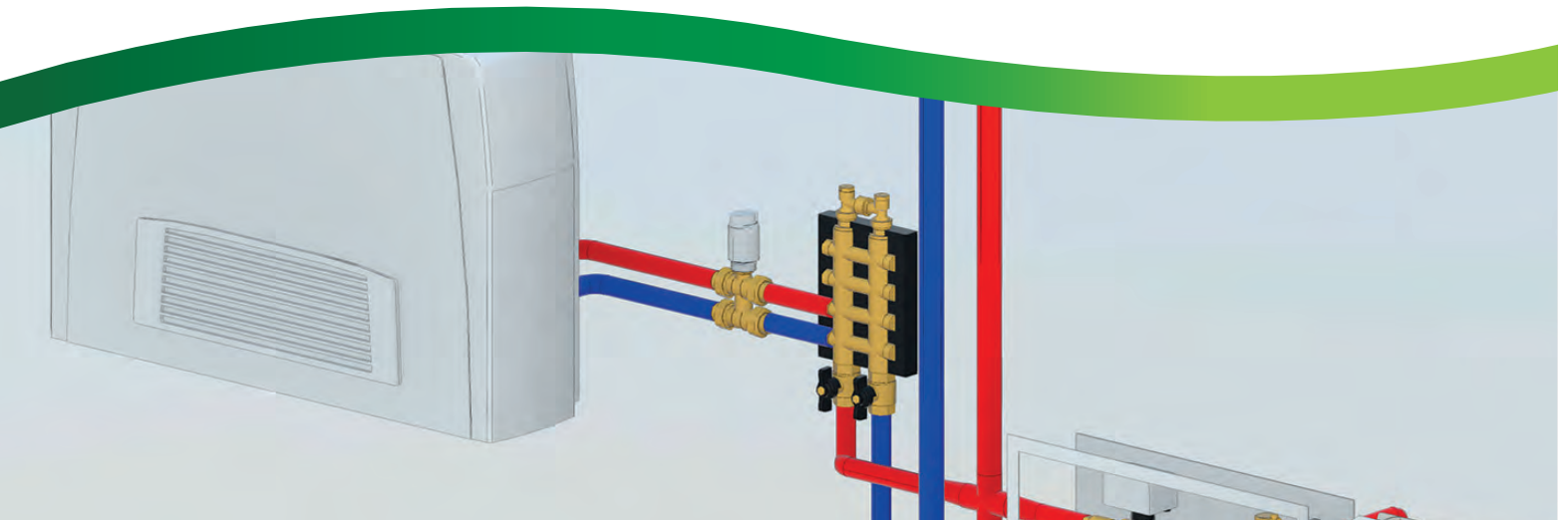

Diagrams made with BIM families: [bim.caleffi.com](http://bim.caleffi.com)

- Motorised ball zone valves**
- Thermo-electric piston zone valves**
- Motorised zone valves with spring return**
- Motorised ball valves**

TWO-WAY VALVES

	Actuator	Application	Type of valve				Type of actuator			Control signal	
			ball	piston	paddle	butterfly	thermo-electric	motorised	motorised with spring return	2 points	3 points
642					●			●	●		
676	656.			●			●		●		
632	630			●			●		●		
6452			●					●	● (R)		
6442 (40 sec)			●					●		●	
6442 (10 sec)			●					●		●	
638		(kit)	●					●		●	

Legend

For heating systems

For cooling systems

Suitable for cooling with the use of insulation

For domestic water systems (check legislation in individual countries)

(R) with internal relay

(kit) with optional insulation kit

THREE-WAY VALVES

	Actuator	Application	Type of valve			Type of actuator			Control signal	
			ball	piston	paddle	thermo-electric	motorised	motorised with spring return	2 points	3 points
643					●			●	●	
677	656.			●		●			●	
678	656.			●		●			●	
633	630			●		●			●	
6453			●				●		●	(R)
6443 (40 sec)		(kit)	●				●			●
6443 (10 sec)		(kit)	●				●			●
6443.. 3BY			●				●			●
6444			●				●			●
638 ("T" drilling)		(kit)	●				●			●
638 ("L" drilling)		(kit)	●				●			●

MOTORIZED TWO-WAY BALL ZONE VALVES

Operating time 10 s

6442

tech. broch. 01131



Motorised two-way ball valve.  
Max. working pressure: 10 bar.  
Max. Δp: 10 bar.  
Temperature range: -5–110 °C.

**Equipped with actuator with 3-contact control. With auxiliary microswitch.**  
Supply: 230 V (AC) or 24 V (AC).  
Auxiliary microswitch contact rating: 0,8 A (230 V).  
Ambient temperature range: 0–55 °C.  
Protection class: IP 54.  
**Operating time: 10 s (90° rotation).**  
Cable length: 100 cm.  
PATENT.



Code	Supply voltage V	Kv (m <sup>3</sup> /h)	Power consumption (VA)		
644246	1/2"	230	11,1	4	1 10
644256	3/4"	230	11,1	4	1 10
644248	1/2"	24	11,1	8	1 10
644258	3/4"	24	11,1	8	1 10

Operating time 40 s

6442

tech. broch. 01131



Motorised two-way ball zone valve.  
Max. working pressure: 10 bar.  
Max. Δp: 10 bar.  
Temperature range: -5–110 °C.

**Equipped with actuator with 3-contact control. With auxiliary microswitch.**  
Supply: 230 V (AC) or 24 V (AC).  
Auxiliary microswitch contact rating: 0,8 A (230 V).  
Ambient temperature range: 0–55 °C.  
Protection class: IP 54.  
**Operating time: 40 s (90° rotation).**  
Length of supply cable: 100 cm.  
PATENT.



Code	Supply voltage V	Kv (m <sup>3</sup> /h)	Power consumption (VA)		
644242	1/2"	230	11,1	4	1 10
644252	3/4"	230	11,1	4	1 10
644262	1"	230	11,1	4	1 10
644244	1/2"	24	11,1	8	1 10
644254	3/4"	24	11,1	8	1 10
644264	1"	24	11,1	8	1 10

MOTORIZED THREE-WAY BALL DIVERTER VALVES

Operating time 10 s

6443

tech. broch. 01132



Motorised three-way diverter valve.  
Max. working pressure: 10 bar.  
Max. Δp: 10 bar.  
Temperature range: -5–110 °C.

**Equipped with actuator with 3-contact control. With auxiliary microswitch.**  
Supply: 230 V (AC) or 24 V (AC).  
Auxiliary microswitch contact rating: 0,8 A (230 V).  
Ambient temperature range: 0–55 °C.  
Protection class: IP 54.  
**Operating time: 10 s (rotation 90°).**  
Cable length: 100 cm.  
PATENT.



Code	Supply voltage V	Kv (m <sup>3</sup> /h)	Power consumption (VA)		
644346	1/2"	230	3,9	4	1 5
644356	3/4"	230	3,9	4	1 5
644357	3/4"	230	8,6	4	1 5
644366	1"	230	9,0	4	1 5
644348	1/2"	24	3,9	8	1 5
644358	3/4"	24	3,9	8	1 5
644359	3/4"	24	8,6	8	1 5
644368	1"	24	9,0	8	1 5

Operating time 40 s

6443

tech. broch. 01132



Motorised three-way diverter valve.  
Max. working pressure: 10 bar.  
Max. Δp: 10 bar.  
Temperature range: -5–110 °C.

**Equipped with actuator with 3-contact control. With auxiliary microswitch.**  
Supply: 230 V (AC) or 24 V (AC).  
Auxiliary microswitch contact rating: 0,8 A (230 V).  
Ambient temperature range: 0–55 °C.  
Protection class: IP 54.  
**Operating time: 40 s (90° rotation).**  
Cable length: 100 cm.  
PATENT.



Code	Supply voltage V	Kv (m <sup>3</sup> /h)	Power consumption (VA)		
644342	1/2"	230	3,9	4	1 5
644352	3/4"	230	3,9	4	1 5
644353	3/4"	230	8,6	4	1 5
644362	1"	230	9,0	4	1 5
644344	1/2"	24	3,9	8	1 5
644354	3/4"	24	3,9	8	1 5
644355	3/4"	24	8,6	8	1 5
644364	1"	24	9,0	8	1 5



### MOTORISED BALL DIVERTER VALVES BY-PASS VERSION

#### 6443.. 3BY tech. broch. 01131



Motorised three-way ball zone valve, by-pass version.  
Max. working pressure: 10 bar.  
Max. Δp: 10 bar.  
Temperature range: -5–110 °C.

**Equipped with actuator with 3-contact control. With auxiliary microswitch.**  
Supply: 230 V (AC) or 24 V (AC).  
Auxiliary microswitch contact rating: 0,8 A (230 V).  
Ambient temperature range: 0–55 °C.  
Protection class: IP 54.  
Operating time: 40 s (90° rotation).  
Length of supply cable: 100 cm.  
PATENT.



Code	Supply voltage V	Kv (m <sup>3</sup> /h) straight	Kv (m <sup>3</sup> /h) by-pass	Power consumption (VA)		
644342 3BY	1/2"	230	10,3	1,8	4	1 5
644352 3BY	3/4"	230	10,3	1,8	4	1 5
644362 3BY	1"	230	10,3	1,8	4	1 5
644344 3BY	1/2"	24	10,3	1,8	8	1 5
644354 3BY	3/4"	24	10,3	1,8	8	1 5
644364 3BY	1"	24	10,3	1,8	8	1 5

### MOTORISED BALL DIVERTER VALVES WITH TELESCOPIC BY-PASS TEE

#### 6444 tech. broch. 01131



Motorised three-way ball zone valve with telescopic by-pass tee.  
Max. working pressure: 10 bar.  
Max. Δp: 10 bar.  
Temperature range: -5–110 °C.  
Tee complete with nozzle U6.

**Adjustable outlet centre distance from 49 to 63 mm.**

**Equipped with actuator with 3-contact control. With auxiliary microswitch.**  
Supply: 230 V (AC) or 24 V (AC).  
Auxiliary microswitch contact rating: 0,8 A (230 V).  
Ambient temperature range: 0–55 °C.  
Protection class: IP 54.  
Operating time: 40 s (90° rotation).  
Length of supply cable: 100 cm.  
PATENT.



Code	Supply voltage V	Kv (m <sup>3</sup> /h) straight	Kv (m <sup>3</sup> /h) by-pass	Power consumption (VA)		
644442	1/2"	230	10,3	1,2	4	1 5
644452	3/4"	230	10,3	1,2	4	1 5
644462	1"	230	10,3	1,2	4	1 5
644444	1/2"	24	10,3	1,2	8	1 5
644454	3/4"	24	10,3	1,2	8	1 5
644464	1"	24	10,3	1,2	8	1 5

### ACCESSORIES AND SPARE PARTS

#### **NEW** 6440 tech. broch. 01132



3-contact control spare actuator for motorised ball zone valves 6443 series.  
**Operating time 10 s.**  
Supply: 230 V (AC) or 24 V (AC).



Code	Supply voltage V		
644032	230	1	10
644034	24	1	10

#### **NEW** 6440 tech. broch. 01132



3-contact control spare actuator for motorised ball zone valve 6443 series.  
**Operating time 40 s.**  
Supply: 230 V (AC) or 24 V (AC).



Code	Supply voltage V		
644022	230	1	10
644024	24	1	10

Insulation kit for heating and cooling systems.  
Medium temperature range: -10–110 °C.  
For motorised three-way ball valves 644 series.



Code	Use		
CBN644357	644353/57/62/66/55/59/64/68	1	-

#### Operating diagram for 6443 series valve Operating time 10 s and 40 s - with "T" drilling

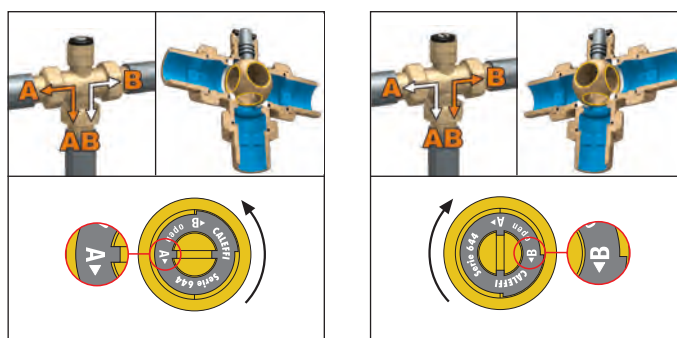

MOTORIZED TWO-WAY BALL ZONE VALVES WITH INSULATION



6452

tech. broch. 01199

Motorised two-way ball zone valve, for heating and cooling systems. With manual opening lever.

**With insulation.**

Max. working pressure: 10 bar.  
Max. Δp: 10 bar.  
Temperature range: -10–110 °C.

**With auxiliary microswitch.**

Supply: 230 V (AC) o 24 V (AC).  
Power consumption: 6 VA.  
Auxiliary microswitch contact rating: 6 (2) A (230 V).  
Ambient temperature range: -10–55 °C.  
Protection class: IP 65.  
Operating time: 50 s (90° rotation).  
Length of supply cable: 80 cm.



Code	Supply voltage V	Kv (m³/h)		
645242	1/2" 230	17,00	1	-
645252	3/4" 230	17,27	1	-
645262	1" 230	36,58	1	-
645272	1 1/4" 230	39,50	1	-
645244	1/2" 24	17,00	1	-
645254	3/4" 24	17,27	1	-
645264	1" 24	36,58	1	-
645274	1 1/4" 24	39,50	1	-



6450

tech. broch. 01199

Spare actuator for motorised ball zone valves 6452 and 6453 series. Supply: 230 V (AC) or 24 V (AC).



Code	Supply voltage V		
645002	230	1	-
645004	24	1	-

**Wiring diagram for 6452 and 6453 series valves, two point actuator with internal relays, valve in closed position**

- R relay
- MC1 opening end microswitch.
- MC2 closing end microswitch.
- MICRO AUX free auxiliary microswitch.

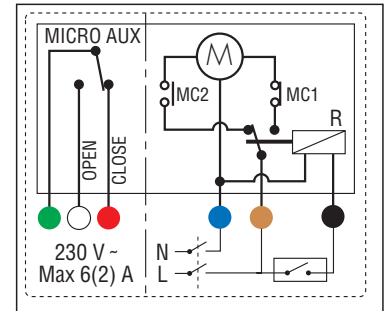

## MOTORISED THREE-WAY BALL ZONE VALVES WITH INSULATION

### 6453

tech. broch. 01199



Motorised three-way ball zone valve, for heating and cooling systems. With manual opening lever. **With insulation.** Max. working pressure: 10 bar. Max. Δp: 10 bar. Temperature range: -10–110 °C.

**With auxiliary microswitch.** Supply: 230 V (AC) o 24 V (AC). Power consumption: 6 VA. Auxiliary microswitch contact rating: 6 (2) A (230 V). Ambient temperature range: -10–55 °C. Protection class: IP 65. Operating time: 50 s (90° rotation). Length of supply cable: 80 cm.



Code	Supply voltage V	Kv (m³/h) straight	Kv (m³/h) by-pass		
645342	1/2"	230	14,10	2,45	1 -
645352	3/4"	230	14,43	2,50	1 -
645362	1"	230	33,52	3,60	1 -
645372	1 1/4"	230	36,00	3,80	1 -
645344	1/2"	24	14,10	2,45	1 -
645354	3/4"	24	14,43	2,50	1 -
645364	1"	24	33,52	3,60	1 -
645374	1 1/4"	24	36,00	3,80	1 -

## ACCESSORIES AND SPARE PARTS

### 6459

tech. broch. 01199



Shell insulation for motorised ball zone valves 6453 series with by-pass tee 6459 and 6490 series. Fitted for manifolds 356... IS series.

Code

Code	Supply voltage V		
645901	1/2" - 3/4"	1	-
645900	1" - 1 1/4"	1	-

### 6450

tech. broch. 01199



Spare actuator for motorised ball zone valves 6452 and 6453 series. Supply: 230 V (AC) or 24 V (AC).



Code	Supply voltage V		
645002	230	1	-
645004	24	1	-



### 6459

tech. broch. 01199

By-pass tee. For motorised ball zone valves 6453 series. **With insulation.** Max. working pressure: 10 bar. Max. Δp: 10 bar. Temperature range: -10–110 °C.

Code	Supply voltage V	Kv (m³/h) tee + valve in by-pass		
645940	1/2"	without nozzle	2,20	1 -
645950	3/4"	without nozzle	2,25	1 -
645960	1"	without nozzle	3,25	1 -
645970	1 1/4"	without nozzle	3,40	1 -

### Wiring diagram for 6452 and 6453 series valves, two point actuator with internal relais, valve in closed position

- R relay
- MC1 opening end microswitch.
- MC2 closing end microswitch.
- MICRO AUX free auxiliary microswitch.

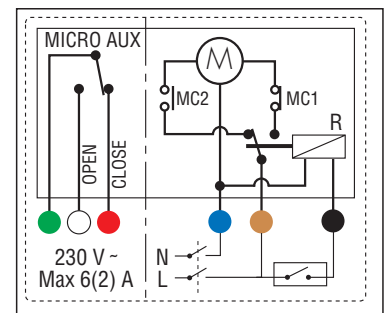

MOTORISED TWO-WAY BALL VALVES FOR HIGH FLOW RATES



638

tech. broch. 01196

Motorised two-way ball valve.  
**With auxiliary microswitch.**  
 Supply: 230 V (AC) or 24 V (AC).  
 Max. working pressure: 16 bar.  
 Max. Δp: 3/4"-1 1/4": 10 bar,  
 1 1/2"-2": 5 bar.  
 Temperature range: -10-110 °C.  
 Ambient temperature range: -10-55 °C.  
 Power consumption: 6 VA.  
 Auxiliary microswitch contact rating:  
 6 (2) A - 230 V (AC).  
 Protection class: IP 65.  
 Operating time: 50 s (90° rotation).

Code	Actuator torque (N-m)	Supply voltage V	Kv (m <sup>3</sup> /h)		
638052	3/4"	15	230	17	1 -
638062	1"	15	230	36,5	1 -
638072	1 1/4"	15	230	48	1 -
638082	1 1/2"	15	230	77	1 -
638092	2"	15	230	140	1 -
638054	3/4"	15	24	17	1 -
638064	1"	15	24	36,5	1 -
638074	1 1/4"	15	24	48	1 -
638084	1 1/2"	15	24	77	1 -
638094	2"	15	24	140	1 -



Spare actuators for motorised two-way valves 638 series. 90° rotation.  
 Supply: 230 V (AC) or 24 V (AC).



Code	Supply voltage V		
638012	230	1	-
638014	24	1	-

Insulation kit for heating and cooling systems. Medium temperature range: -10-110 °C. For motorised two-way ball valves 638 series.



Code	Use		
CBN638052	3/4"	1	-
CBN638062	1"	1	-
CBN638072	1 1/4"	1	-
CBN638082	1 1/2"-2"	1	-

Insulation kit for heating and cooling systems. Medium temperature range: -10-110 °C. For motorised three-way ball valves 638 series.



Code	Use		
CBN638053	3/4" with "L" drilling	1	-
CBN638063	1" with "L" drilling	1	-
CBN638073	1 1/4" with "L" drilling	1	-
CBN638083	1 1/2"-2" with "L" drilling	1	-
CBN638153	3/4" with "T" drilling	1	-
CBN638163	1" with "T" drilling	1	-
CBN638173	1 1/4" with "T" drilling	1	-
CBN638183	1 1/2"-2" with "T" drilling	1	-

Wiring diagram for two-way and three-way ball valves 638 series with 3-contact actuator

Internal diagram with valve in the following position:  
 - Closed, for two-way valve.  
 - Port A closed for three-way valves.

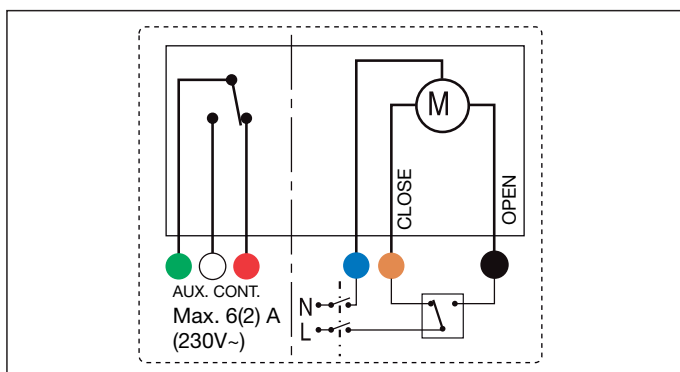

MOTORISED THREE-WAY BALL VALVES FOR HIGH FLOW RATES

“T” drilling

638

tech. broch. 01196



Motorised three-way ball valve.  
**With auxiliary microswitch.**  
 Supply: 230 V (AC) or 24 V (AC).  
 Max. working pressure: 16 bar.  
 Max. Δp: 10 bar.  
 Temperature range: -10–110 °C.  
 Ambient temperature range: -10–55 °C.  
 Power consumption: 6 VA.  
 Auxiliary microswitch contact rating:  
 6 (2) A - 230 V (AC).  
 Protection class: IP 65.  
 Operating time: 50 s (90° rotation).  
**(90° rotation - with “T” drilling  
 - reduced bore).**



Code	Actuator torque (N-m)	Supply voltage V	Kv (m <sup>3</sup> /h)		
638153	3/4"	15	230	9,5	1 -
638163	1"	15	230	12,9	1 -
638173	1 1/4"	15	230	24,7	1 -
638183	1 1/2"	15	230	47	1 -
638193	2"	15	230	50	1 -
638155	3/4"	15	24	9,5	1 -
638165	1"	15	24	12,9	1 -
638175	1 1/4"	15	24	24,7	1 -
638185	1 1/2"	15	24	47	1 -
638195	2"	15	24	50	1 -

Spare actuators for motorised three-way valves 638 series.  
 With “T” drilling. 90° rotation.  
 Supply: 230 V (AC) or 24 V (AC).



Code	Supply voltage V		
638012	230	1	-
638014	24	1	-

Applications

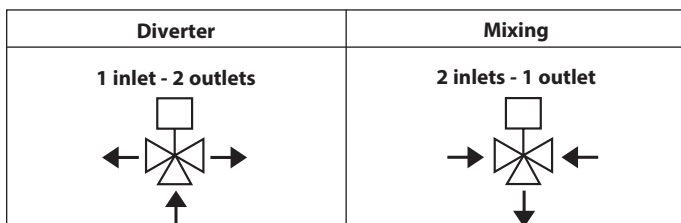

Operating diagram of valves 638 series - “T” drilling

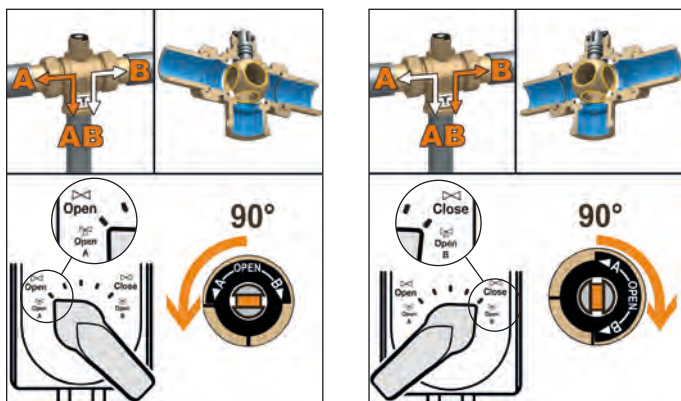

“L” drilling

638

tech. broch. 01196



Motorised three-way ball valve.  
**With auxiliary microswitch.**  
 Supply: 230 V (AC) or 24 V (AC).  
 Max. working pressure: 16 bar.  
 Max. Δp: 10 bar.  
 Temperature range: -10–110 °C.  
 Ambient temperature range: -10–55 °C.  
 Power consumption: 6 VA.  
 Auxiliary microswitch contact rating:  
 6 (2) A - 230 V (AC).  
 Protection class: IP 65.  
 Operating time: 100 s (180° rotation).  
**(180° rotation - with “L” drilling  
 - reduced bore).**



Code	Actuator torque (N-m)	Supply voltage V	Kv (m <sup>3</sup> /h)		
638053	3/4"	15	230	9,9	1 -
638063	1"	15	230	13,4	1 -
638073	1 1/4"	15	230	22,8	1 -
638083	1 1/2"	15	230	44	1 -
638093	2"	15	230	50	1 -
638055	3/4"	15	24	9,9	1 -
638065	1"	15	24	13,4	1 -
638075	1 1/4"	15	24	22,8	1 -
638085	1 1/2"	15	24	44	1 -
638095	2"	15	24	50	1 -

Spare actuators for motorised three-way valves 638 series.  
 With “L” drilling. 180° rotation.  
 Supply: 230 V (AC) or 24 V (AC).



Code	Supply voltage V		
638412	230	1	-
638414	24	1	-

Applications

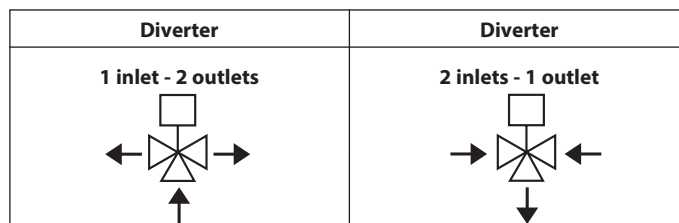

Operating diagram of valves 638 series - “L” drilling

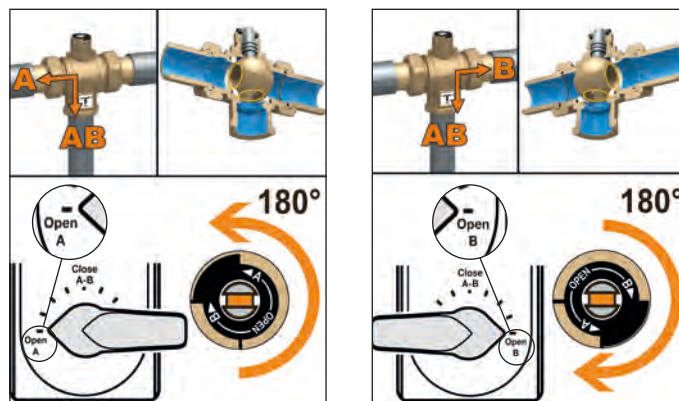

THERMO-ELECTRIC PISTON ZONE VALVES



676

tech. broch. 01343

Two-way zone valve with high flow rate. Fitted for thermo-electric actuators 6563, 6561, 6562 and 6564 series. Max. working pressure: 10 bar. Max. Δp: 2,5 bar. Temperature range: 0–95 °C.

Code		Kv (m <sup>3</sup> /h)		
676500	1"	4,77	1	20



676

tech. broch. 01072

Two-way zone valve. Fitted for thermo-electric actuators 6563, 6561, 6562 and 6564 series. Max. working pressure: 10 bar. Max. Δp: 1,2 bar. Temperature range: 0–95 °C.

Code		Kv (m <sup>3</sup> /h)		
676040	1/2"	3,7	1	10
676050	3/4"	3,7	1	10
676060	1"	3,7	1	10



677

tech. broch. 01072

Three-way zone valve. Fitted for thermo-electric actuators 6563, 6561, 6562 and 6564 series. Max. working pressure: 10 bar. Max. Δp: 1,2 bar. Temperature range: 0–95 °C.

Code		Kv (m <sup>3</sup> /h) straight	Kv (m <sup>3</sup> /h) by-pass		
677040	1/2"	3,7	1,0	1	10
677050	3/4"	3,7	1,0	1	10
677060	1"	3,7	1,0	1	10



678

tech. broch. 01072

Three-way zone valve with by-pass tee. Fitted for thermo-electric actuators 6563, 6561, 6562 and 6564 series. Max. working pressure: 10 bar. Max. Δp: 1,2 bar. Temperature range: 0–95 °C. Tee complete with nozzle U6. **Adjustable outlet centre distance from 49 to 63 mm.**

Code		Kv (m <sup>3</sup> /h) straight	Kv (m <sup>3</sup> /h) by-pass		
678040	1/2"	3,7	1,0	1	10
678050	3/4"	3,7	1,0	1	10
678060	1"	3,7	1,0	1	10



6563

tech. broch. 01142

Thermo-electric actuator. With manual opening and position indicator. Normally closed. **With auxiliary microswitch.** Supply: 230 V (AC) or 24 V (AC)/(DC). Power consumption: 3 W. Starting current: ≤ 1 A. Auxiliary microswitch contact rating: 0,8 A (230 V). Ambient temperature range: 0–50 °C. Protection class: IP 40. PATENT.



Code	Supply voltage V			
656312	230		1	10
656314	24		1	10
656302	230	without auxiliary microswitch	1	10
656304	24	without auxiliary microswitch	1	10



6561

tech. broch. 01042

Thermo-electric actuator. Normally closed. **With auxiliary microswitch.** Supply: 230 V (AC) or 24 V (AC)/(DC). Auxiliary microswitch contact rating: 0,8 A (230 V). Power consumption: 3 W. Starting current: ≤ 1 A. Ambient temperature range: 0–50 °C. Protection class: IP 44 (vertical stem).



Code	Supply voltage V			
656112	230		1	10
656114	24		1	10
656102	230	without auxiliary microswitch	1	10
656104	24	without auxiliary microswitch	1	10



6562

tech. broch. 01198

Thermo-electric actuator. With opening position indicator. **Quick-coupling installation, with a clip adapter.** Normally closed. **With auxiliary microswitch.** Supply: 230 V (AC) or 24 V (AC)/(DC). Auxiliary microswitch contact rating: 0,8 A (230 V). Power consumption: 3 W. Starting current: ≤ 1 A. Ambient temperature range: 0–50 °C. Protection class: IP 54.



Code	Supply voltage V			
656212	230		1	10
656214	24		1	10
656202	230	without auxiliary microswitch	1	10
656204	24	without auxiliary microswitch	1	10



6564

tech. broch. 01198

Thermo-electric actuator with low power consumption. With opening position indicator. **Quick-coupling installation, with a clip adapter.** Normally closed. **With auxiliary microswitch.** Supply: 230 V (AC) or 24 V (AC)/(DC). Auxiliary microswitch contact rating: 0,8 A (230 V). Power consumption: 3 W. Starting current: ≤ 250 mA. Ambient temperature range: 0–50 °C. Protection class: IP 54.



Code	Supply voltage V			
656412	230		1	10
656414	24		1	10
656402	230	without auxiliary microswitch	1	10
656404	24	without auxiliary microswitch	1	10

THERMO-ELECTRIC PISTON ZONE VALVES



**632** *tech. broch. 01039*  
 Two-way piston zone valve.  
 Max. working pressure: 10 bar.  
 Max. Δp: 1 bar.  
 Temperature range: -5–95 °C.

Code		Kv (m³/h)		
632400	1/2"	5,10	1	5
632500	3/4"	6,27	1	5
632600	1"	6,38	1	5



**630** *tech. broch. 01039*  
 Thermo-electric actuator.  
 For zone valves 632 and 633 series.  
 Normally closed.  
 Supply: 230 V (AC)/(DC).  
 Power consumption: 5 W.  
 Starting current: ≤ 1 A.  
 Max. ambient temperature: 55 °C.  
 Protection class:  
 IP 42 (horizontal stem).

Code	Supply voltage V		
630002	230	1	10



**633** *tech. broch. 01039*  
 Three-way piston zone valve.  
 3/4" F by-pass connection.  
 Max. working pressure: 10 bar.  
 Max. Δp: 1 bar.  
 Temperature range: -5–95 °C.

Code		Kv (m³/h) straight	Kv (m³/h) by-pass		
633400	1/2"	4,99	4,33	1	5
633500	3/4"	6,19	4,91	1	5
633600	1"	6,45	5,30	1	5



**630** *tech. broch. 01039*  
 Thermo-electric actuator.  
 For zone valves 632 and 633 series.  
 Normally closed.  
 Supply: 230 V (AC)/(DC) or 24 V (AC)/(DC).  
**With manual actuator and auxiliary microswitch.**  
 Power consumption: - 5 W (230 V)  
                               - 3 W (24 V).  
 Starting current: ≤ 1 A (230 V)  
                               ≤ 350 mA (24 V)  
 Auxiliary microswitch contact rating:  
 6 (3) A (230 V).  
 Max. ambient temperature: 55 °C.  
 Protection class: IP 20.

Code	Supply voltage V		
630112	230	1	10
630114	24	1	10



**635** *tech. broch. 01039*  
 Balanced by-pass tee.  
 For zone valves 633 series.  
 Max. working pressure: 10 bar.  
 Max. Δp: 1 bar.  
 Temperature range: -5–95 °C.

Code		Kv (m³/h) tee + valve in by-pass			
635440	1/2"	U4	0,96	1	5
635460	1/2"	U6	1,32	1	5
635480	1/2"	U8	1,73	1	5
635540	3/4"	U4	0,98	1	5
635560	3/4"	U6	1,36	1	5
635580	3/4"	U8	1,79	1	5
635640	1"	U4	1,02	1	5
635660	1"	U6	1,43	1	5
635680	1"	U8	1,88	1	5

Wiring diagram for piston zone valves 632 and 633 series with thermo-electric actuator

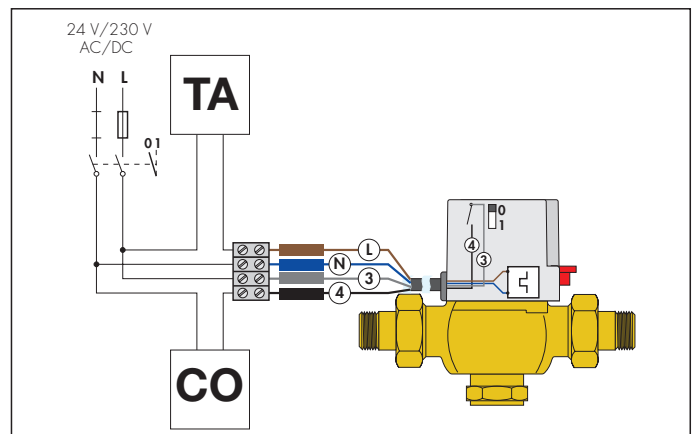

Installation

1. The 2-way zone valve 632 series should be installed on the circuit flow pipe.  
 The 2-way valve cannot be converted into 3-way valve by removing the plug.
2. The 3-way zone valve 633 series should be installed on the circuit return pipe.  
 The 3-way valve cannot be converted into 2-way valve by applying a plug.

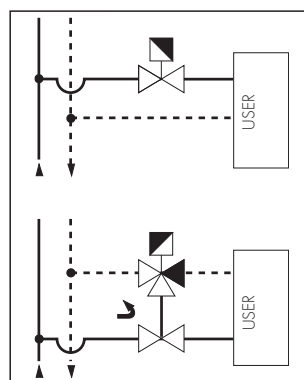

MOTORIZED ZONE VALVES WITH SPRING RETURN

642  
**Z-one™**

tech. broch. 01115



Motorised two-way zone valve. Normally closed.  
**With auxiliary microswitch.**  
 Power consumption: 6,5 W; 7 VA.  
 Auxiliary microswitch contact rating: 0,8 A (230 V).  
 Opening time: 70–75 s.  
 Closing time: 5–7 s.  
 Protection class: IP 20.  
 Max. ambient temperature: 40 °C.  
 Max. working pressure: 16 bar.  
 Temperature range: 0–90 °C.  
 Cable length: 95 cm.



Code		Kv (m <sup>3</sup> /h)	Max. Δp (bar)			
642042	1/2"	2,5	2,10	230 V	1	10
642052	3/4"	4,5	1,50	230 V	1	10
642062	1"	6	1,00	230 V	1	10
642064	1"	6	1,00	24 V	1	10



643  
**Z-one™**

tech. broch. 01115



Motorised three-way zone valve. Normally closed.  
**With auxiliary microswitch.**  
 Power consumption: 6,5 W; 7 VA.  
 Auxiliary microswitch contact rating: 0,8 A (230 V).  
 Opening time: 70–75 s.  
 Closing time: 5–7 s.  
 Protection class: IP 20.  
 Max. ambient temperature: 40 °C.  
 Max. working pressure: 16 bar.  
 Temperature range: 0–90 °C.  
 Cable length: 95 cm.



Code		Kv (m <sup>3</sup> /h)	Max. Δp (bar)			
643042	1/2"	2,5	2,10	230 V	1	10
643052	3/4"	4,5	1,50	230 V	1	10
643062	1"	6	1,00	230 V	1	10



641

tech. broch. 01115



Spare actuator for motorised zone valves 642 and 643 series.



Code					
641002			230 V	1	-



Removable actuator

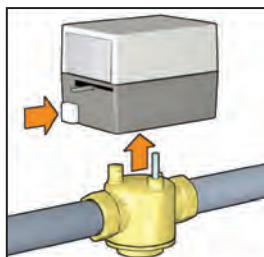
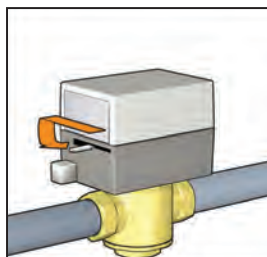

Installation

The 3-way valve cannot be converted into 2-way valve and viceversa.

2-way valve installed on the flow

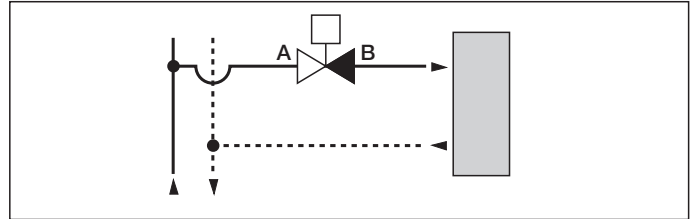

2-way valve installed on the return

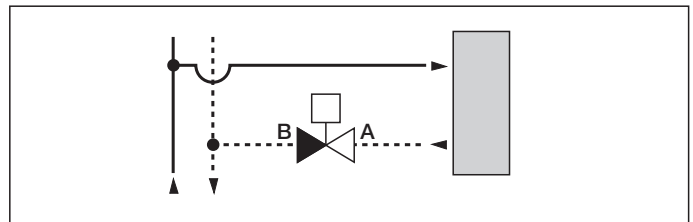

3-way valve installed on the flow with diverting position and ON/OFF use mode

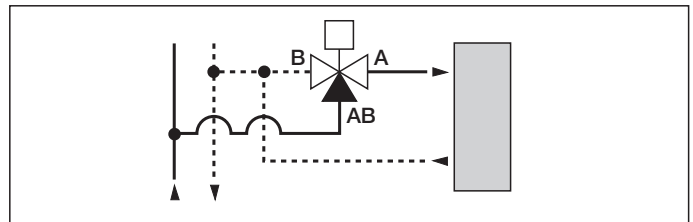

3-way valve installed on the return with mixing position and ON/OFF use mode

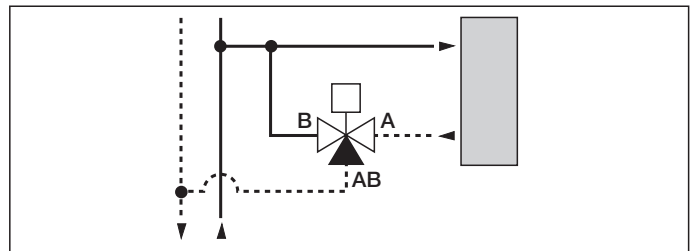

Wiring diagram for spring return valves 642 and 643 series

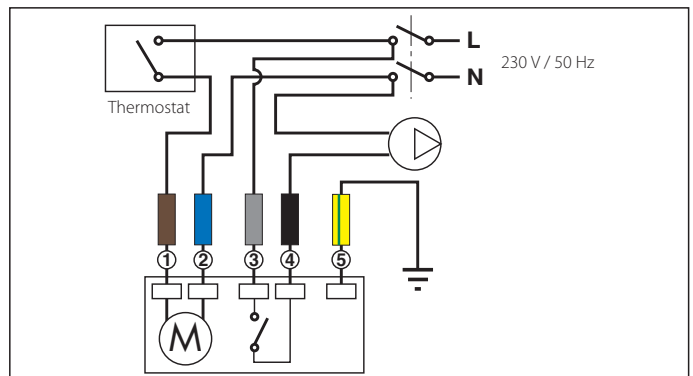



# DISTRIBUTION MANIFOLDS AND BOXES

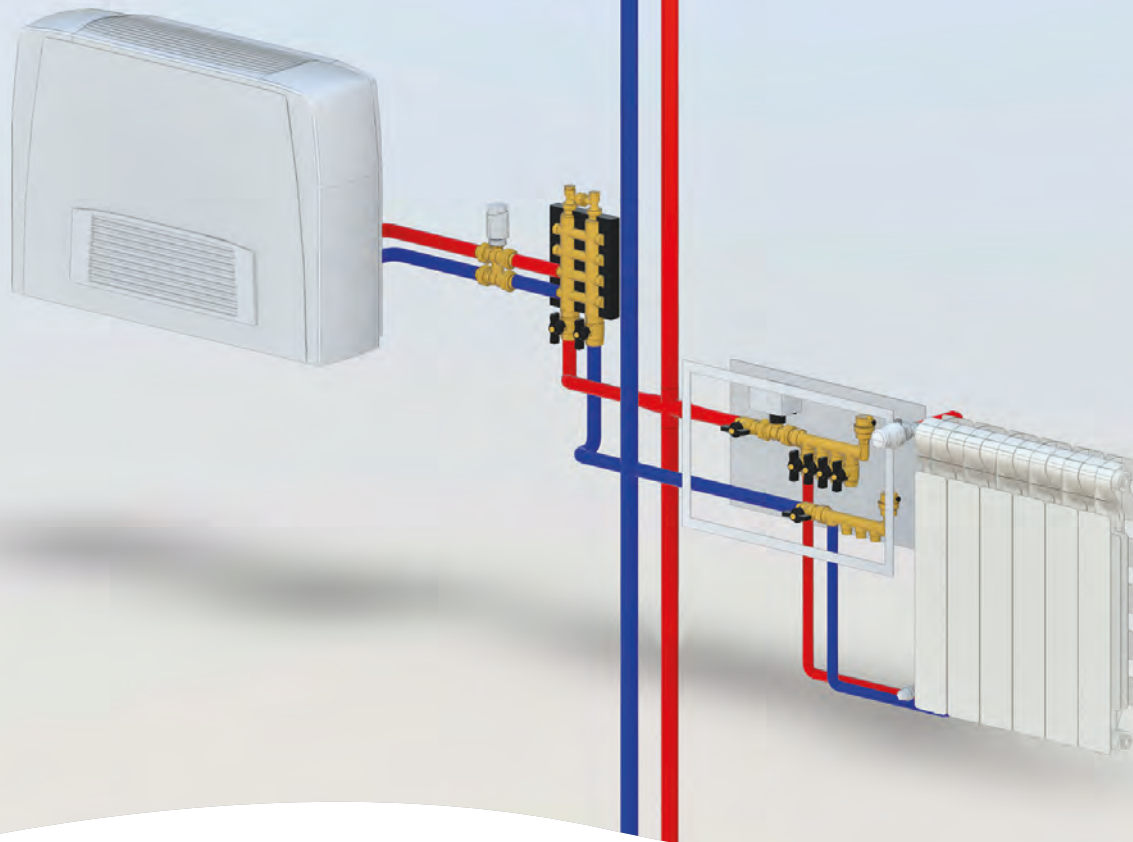

*Diagrams made with BIM families: [bim.caleffi.com](http://bim.caleffi.com)*

**Single manifolds**

**Dual manifolds**

**Manifolds complete with shut-off valves and pre-regulating valves**

**Thermo-electric actuators**

**Accessories**

**Fittings**

**Inspection wall boxes, in plastic**

**Inspection wall boxes, in painted sheet steel**

SINGLE DISTRIBUTION MANIFOLDS / MALE OUTLET



349

Modular single distribution manifold. For heating and cooling systems. Max. working pressure: 10 bar. Temperature range: -10–110 °C. Outlet centre distance: 35 mm.

Code	Connections	Outlet No.	Outlets		
349020	3/4"	x 2	23 p.1,5 M	5	50
349030	3/4"	x 3	23 p.1,5 M	5	50
349040	3/4"	x 4	23 p.1,5 M	5	50
349050	3/4"	x 5	23 p.1,5 M	5	50



349

Modular single distribution manifold. Max. working pressure: 10 bar. Temperature range: -10–110 °C. Outlet centre distance: 35 mm. **Outlet male connections.**

Code	Connections	Outlet No.	Outlets		
349130	3/4"	x 3	1/2" M	5	50
349140	3/4"	x 4	1/2" M	5	50
349150	3/4"	x 5	1/2" M	5	50



350

Modular single distribution manifold. For heating and cooling systems. Max. working pressure: 10 bar. Temperature range: -10–110 °C. Outlet centre distance: 50 mm for 3/4" and 1". Outlet centre distance: 60 mm for 1 1/4". PTFE seal on coupling.

Code	Connections	Outlet No.	Outlets		
350520	3/4"	x 2	23 p.1,5 M	2	–
350530	3/4"	x 3	23 p.1,5 M	2	–
350540	3/4"	x 4	23 p.1,5 M	2	–
350620	1"	x 2	23 p.1,5 M	2	–
350630	1"	x 3	23 p.1,5 M	2	–
350640	1"	x 4	23 p.1,5 M	2	–
350720*	1 1/4"	x 2	23 p.1,5 M	2	–
350730*	1 1/4"	x 3	23 p.1,5 M	2	–
350740*	1 1/4"	x 4	23 p.1,5 M	2	–

\* Without PTFE seal on coupling



349

Modular single distribution manifold. Max. working pressure: 10 bar. Temperature range: -10–110 °C. Con sede piana. **With flat seat for press-fittings.**

Code	Connections	Outlet No.	Outlets		
349230	3/4"	x 3	1/2" M - Ø 13	5	50
349240	3/4"	x 4	1/2" M - Ø 13	5	50
349250	3/4"	x 5	1/2" M - Ø 13	5	50



592

Modular single distribution manifold. Max. working pressure: 10 bar. Temperature range: -10–110 °C. PTFE seal on coupling. **Outlet male connections.**

Code	Connections	Outlet No.	Outlets	Outlet centre distance		
592525	3/4"	x 2	1/2" M	50	2	–
592535	3/4"	x 3	1/2" M	50	2	–
592545	3/4"	x 4	1/2" M	50	2	–
592625	1"	x 2	1/2" M	50	2	–
592635	1"	x 3	1/2" M	50	2	–
592645	1"	x 4	1/2" M	50	2	–
592626	1"	x 2	1/2" M	60	2	–
592636	1"	x 3	1/2" M	60	2	–
592646	1"	x 4	1/2" M	60	2	–
592726*	1 1/4"	x 2	1/2" M	60	2	–
592736*	1 1/4"	x 3	1/2" M	60	2	–
592746*	1 1/4"	x 4	1/2" M	60	2	–
592622	1"	x 2	3/4" M	60	2	–
592632	1"	x 3	3/4" M	60	2	–

\* Without PTFE on coupling

**SINGLE DISTRIBUTION MANIFOLDS / FEMALE OUTLET**



**349**

Modular single distribution manifold.  
Max. working pressure: 10 bar.  
Temperature range: -10–110 °C.  
Outlet centre distance: 35 mm.  
**Outlet female connections.**

Code	Connections	Outlet No.	Outlets		
349330	3/4"	x 3	1/2" F	5	50
349340	3/4"	x 4	1/2" F	5	50
349350	3/4"	x 5	1/2" F	5	50

**592**



Modular single distribution manifold.  
Max. working pressure: 10 bar.  
Temperature range: -10–110 °C.  
PTFE seal on coupling.  
**Outlet female connections.**

Code	Connections	Outlet No.	Outlets	Outlet centre distance		
592527	3/4"	x 2	1/2" F	50	2	-
592537	3/4"	x 3	1/2" F	50	2	-
592547	3/4"	x 4	1/2" F	50	2	-
592627	1"	x 2	1/2" F	50	2	-
592637	1"	x 3	1/2" F	50	2	-
592647	1"	x 4	1/2" F	50	2	-
592628	1"	x 2	1/2" F	60	2	-
592638	1"	x 3	1/2" F	60	2	-
592648	1"	x 4	1/2" F	60	2	-
592728*	1 1/4"	x 2	1/2" F	60	2	-
592738*	1 1/4"	x 3	1/2" F	60	2	-
592748*	1 1/4"	x 4	1/2" F	60	2	-

\* Without PTFE on coupling

**BLIND SINGLE DISTRIBUTION MANIFOLDS**

**351**

Blind single distribution manifold.  
For heating and cooling systems.  
Max. working pressure: 10 bar.  
Temperature range: -10–110 °C.  
Outlet centre distance: 50 mm.



Code	Connections	Outlet No.	Outlets		
351520	3/4"	x 2	23 p.1,5 M	2	-
351530	3/4"	x 3	23 p.1,5 M	2	-
351540	3/4"	x 4	23 p.1,5 M	2	-
351620	1"	x 2	23 p.1,5 M	2	-
351630	1"	x 3	23 p.1,5 M	2	-
351640	1"	x 4	23 p.1,5 M	2	-

**598**



Blind single distribution manifold.  
For heating and cooling systems.  
Max. working pressure: 10 bar.  
Temperature range: -10–110 °C.  
Outlet centre distance: 50 mm.  
**Outlet female connections.**

Code	Connections	Outlet No.	Outlets		
598522	3/4"	x 2	1/2" F	2	-
598532	3/4"	x 3	1/2" F	2	-
598542	3/4"	x 4	1/2" F	2	-
598622	1"	x 2	1/2" F	2	-
598632	1"	x 3	1/2" F	2	-
598642	1"	x 4	1/2" F	2	-



**SINGLE DISTRIBUTION MANIFOLDS WITH SHUT-OFF VALVES**



**354**

Modular single distribution manifold with shut-off valves.  
**CR** dezincification resistant alloy body.  
 Max. working pressure: 10 bar.  
 Temperature range: 5–100 °C.  
 Outlet centre distance: 35 mm.





Code	Connections	Outlet No.	Outlets		
<b>354052</b>	3/4"	x 2	23 p.1,5 M	5	20
<b>354053</b>	3/4"	x 3	23 p.1,5 M	5	20
<b>354054</b>	3/4"	x 4	23 p.1,5 M	5	20
<b>354055</b>	3/4"	x 5	23 p.1,5 M	5	20



**354**

Modular single distribution manifold with shut-off valves.  
 Brass body.  
 Max. working pressure: 10 bar.  
 Temperature range: 5–100 °C.  
 Outlet centre distance: 35 mm.  
**Outlet male connections.**  
 With flat seat.  
**For press-fittings.**



Code	Connections	Outlet No.	Outlets		
<b>354252</b>	3/4"	x 2	1/2" M - Ø 13	2	30
<b>354253</b>	3/4"	x 3	1/2" M - Ø 13	2	20
<b>354254</b>	3/4"	x 4	1/2" M - Ø 13	2	10
<b>354255</b>	3/4"	x 5	1/2" M - Ø 13	2	10



**SINGLE DISTRIBUTION MANIFOLDS FOR AIR CONDITIONING SYSTEMS**



**650**

tech. broch. 01067

Modular single distribution manifold. For air conditioning systems.  
**With insulation.**  
 Max. working pressure: 10 bar.  
 Temperature range: -40–95 °C.  
 Outlet centre distance: 60 mm.

Code	Connections	Outlet No.	Outlets		
<b>650622</b>	1"	x 2	3/4" M	2	–
<b>650632</b>	1"	x 3	3/4" M	2	–
<b>650722</b>	1 1/4"	x 2	3/4" M	2	–
<b>650732</b>	1 1/4"	x 3	3/4" M	2	–
<b>650742</b>	1 1/4"	x 4	3/4" M	2	–

DUAL DISTRIBUTION MANIFOLDS AND FITTINGS

356

tech. broch. 01014



Cast monoblock dual distribution manifold. For heating and cooling systems. Max. working pressure: 10 bar. Temperature range: -10–110 °C. Main centre distance: 60 mm. Outlet centre distance: 40 mm.

Code	Connections	Outlet No.	Outlets		
356502	3/4"	2+2	23 p.1,5 M	1	5
356504	3/4"	4+4	23 p.1,5 M	1	5
356506	3/4"	6+6	23 p.1,5 M	1	5
356508	3/4"	8+8	23 p.1,5 M	1	5
356510	3/4"	10+10	23 p.1,5 M	1	5
356604	1"	4+4	23 p.1,5 M	1	5
356606	1"	6+6	23 p.1,5 M	1	5
356608	1"	8+8	23 p.1,5 M	1	5
356610	1"	10+10	23 p.1,5 M	1	5
356612	1"	12+12	23 p.1,5 M	1	-

356

tech. broch. 01014

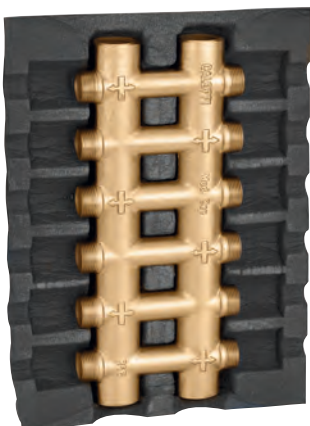

Cast monoblock dual distribution manifold. For heating and cooling systems. **With insulation.** Max. working pressure: 10 bar. Temperature range: 0–100 °C. Main centre distance: 60 mm. Outlet centre distance: 40 mm.

Code	Connections	Outlet No.	Outlets		
356604 IS	1"	4+4	23 p.1,5 M	1	10
356606 IS	1"	6+6	23 p.1,5 M	1	10
356608 IS	1"	8+8	23 p.1,5 M	1	5
356610 IS	1"	10+10	23 p.1,5 M	1	5

357

tech. broch. 01014



Single sided cast monoblock dual distribution manifold. For heating and cooling systems. Max. working pressure: 10 bar. Temperature range: -10–110 °C. Main centre distance: 60 mm. Outlet centre distance: 40 mm.

Code	Connections	Outlet No.	Outlets		
357502	3/4"	2+2	23 p.1,5 M	1	10
357503	3/4"	3+3	23 p.1,5 M	1	10
357504	3/4"	4+4	23 p.1,5 M	1	5
357505	3/4"	5+5	23 p.1,5 M	1	-
357506	3/4"	6+6	23 p.1,5 M	1	-

356

tech. broch. 01014



Differential by-pass for dual distribution manifolds 356 and 357 series. 3/8" connection for automatic air vent. Fixed differential by-pass setting: 20 kPa (2000 mm w.g.). Max. working pressure: 10 bar. Temperature range: -10–110 °C.

Code	Connections	Outlet No.	Outlets		
356050	3/4" M			1	20

3640

End fitting. For distribution manifolds 356 and 357 series.



Code	Connections	Outlet No.	Outlets		
364050	3/4" M x	23 p.1,5 M		2	-
364060	1" M x	23 p.1,5 M		2	-

3641

Plug. For distribution manifolds 356 and 357 series.



Code	Connections	Outlet No.	Outlets		
364150	3/4" M			2	-
364160	1" M			2	-

3642

End fitting for air vent connection. For distribution manifolds 356 and 357 series.



Code	Connections	Outlet No.	Outlets		
364253	3/4" M x	3/8" F		2	-
364254	3/4" M x	1/2" F		2	-
364263	1" M x	3/8" F		2	-

**DISTRIBUTION MANIFOLDS WITH SHUT-OFF AND PRE-REGULATING VALVES**

**1" CONNECTIONS**

**662**



Distribution manifold group.  
Max. working pressure: 10 bar.  
Temperature range: 5–100 °C.  
Outlet centre distance: 50 mm.

tech. broch. 01180

Consisting of:

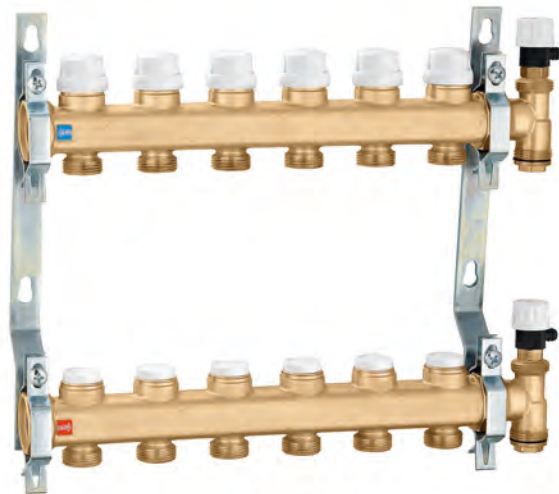
- return manifold complete with shut-off valves fitted for thermo-electric actuator;
- flow manifold complete with lockshield valves for flow rate pre-regulation;
- end fittings consisting of double radial end fitting, manual air vent and plugs;
- steel mounting brackets for use with box 659 series or for direct wall fixing.



Code	Connections	Outlet No.	Outlets		
6626B5	1"	x 2	3/4" M	1	-
6626C5	1"	x 3	3/4" M	1	-
6626D5	1"	x 4	3/4" M	1	-
6626E5	1"	x 5	3/4" M	1	-
6626F5	1"	x 6	3/4" M	1	-
6626G5	1"	x 7	3/4" M	1	-
6626H5	1"	x 8	3/4" M	1	-
6626I5	1"	x 9	3/4" M	1	-
6626L5	1"	x 10	3/4" M	1	-
6626M5	1"	x 11	3/4" M	1	-
6626N5	1"	x 12	3/4" M	1	-
6626O5	1"	x 13	3/4" M	1	-

Insulation for distribution manifolds 662, 664 and 665 series.  
For heating and cooling systems.  
**For use with box code 659..4**  
(adjustable depth from 110 to 140 mm).



Code

<b>CBN6646F1</b>	for manifolds from 2 to 6 outlets	1	-
<b>CBN6646N1</b>	for manifolds from 7 to 12 outlets	1	-
<b>CBN6646O1</b>	for manifolds with 13 outlets	1	-

**391**

Pair of ball shut-off valves with O-Ring seal.  
For distribution manifolds 664 and 665 series.  
Female - male connections with union with O-Ring seal.

Max. working pressure: 10 bar.  
Temperature range: 5–100 °C.



Code

<b>391066</b>	1"	1	-
---------------	----	---	---

DISTRIBUTION MANIFOLDS WITH SHUT-OFF AND PRE-REGULATING VALVES

1" CONNECTIONS

662

tech. broch. 01180

Pair of manifolds equipped with shut-off and lockshield valves for flow rate pre-regulation. Max. working pressure: 10 bar. Temperature range: 5–100 °C. Outlet centre distance: 50 mm.

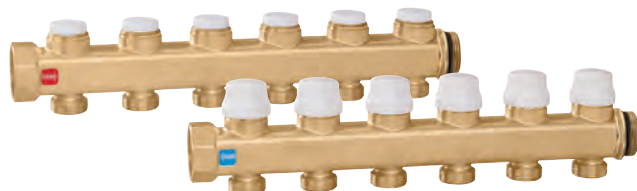

Code	Connections	Outlet No.	Outlets		
662625	1" x 2	x 2	3/4" M	1	–
662635	1" x 3	x 3	3/4" M	1	–
662645	1" x 4	x 4	3/4" M	1	–
662655	1" x 5	x 5	3/4" M	1	–
662665	1" x 6	x 6	3/4" M	1	–

6620

tech. broch. 01180

Return manifold equipped with shut-off valves, fitted for thermo-electric actuator. Max. working pressure: 10 bar. Temperature range: 5–100 °C. Outlet centre distance: 50 mm.



Code	Connections	Outlet No.	Outlets		
662025	1" x 2	x 2	3/4" M	2	–
662035	1" x 3	x 3	3/4" M	2	–
662045	1" x 4	x 4	3/4" M	2	–
662055	1" x 5	x 5	3/4" M	2	–
662065	1" x 6	x 6	3/4" M	2	–

6621

tech. broch. 01180

Flow manifold equipped with lockshield valves for flow rate pre-regulation. Max. working pressure: 10 bar. Temperature range: 5–100 °C. Outlet centre distance: 50 mm.



Code	Connections	Outlet No.	Outlets		
662125	1" x 2	x 2	3/4" M	2	–
662135	1" x 3	x 3	3/4" M	2	–
662145	1" x 4	x 4	3/4" M	2	–
662155	1" x 5	x 5	3/4" M	2	–
662165	1" x 6	x 6	3/4" M	2	–



5996

tech. broch. 01180

End fitting consisting of double radial end fitting, air vent cock and plug. Max. working pressure: 10 bar. Temperature range: 5–100 °C.

Code	Connections		
59962	1" F	1	25



662

tech. broch. 01180

Fixed setting differential by-pass kit 20 kPa (2000 mm w.g.), with flexible hose. For distribution manifolds 662 series. Max. working pressure: 10 bar. Temperature range: 0–100 °C.

Code	Connections		
662000	3/4" F nut x 3/4" F	1	5

Connection example of differential by-pass code 662000 with manifold 662 series

This special by-pass kit consists of a flexible hose which makes installation easier and allows the manifold to be adapted to suit the brackets, according to the actual positions of the system flow and return piping.

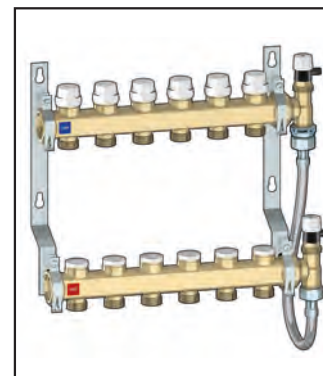

658

Pair of steel mounting brackets for distribution manifolds 662 and 664 series. To be used with boxes code 659..5 or directly wall mounted.

Code		
658101	1	–



658

tech. broch. 01180

Polymer mounting brackets with adjustable centre distance, for distribution manifolds 662 series. With screws and wall anchors. To be used with boxes code 659..4 (depth 110–140 mm) or directly wall mounted.

Code		
658400	1	5

DISTRIBUTION MANIFOLDS WITH SHUT-OFF AND PRE-REGULATING VALVES

1 1/4" CONNECTIONS

663

tech. broch. 01065

Pre-assembled distribution manifold.  
 Max. working pressure: 10 bar.  
 Temperature range: 5–100 °C.  
 Outlet centre distance: 50 mm.

Consisting of:

- 1 return distribution manifold complete with shut-off valves fitted for thermo-electric actuator;
- 1 flow distribution manifold complete with lockshield valves for flow rate pre-regulation;
- 2 mounting brackets code 658100;
- 2 reduction fittings 1 1/4" M x 1" F code 364276;
- 2 double radial end fittings with plugs.

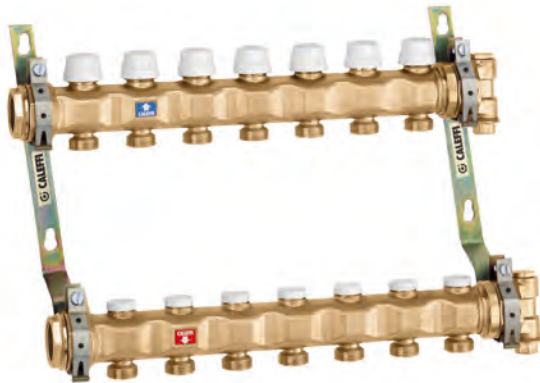

663



tech. broch. 01065

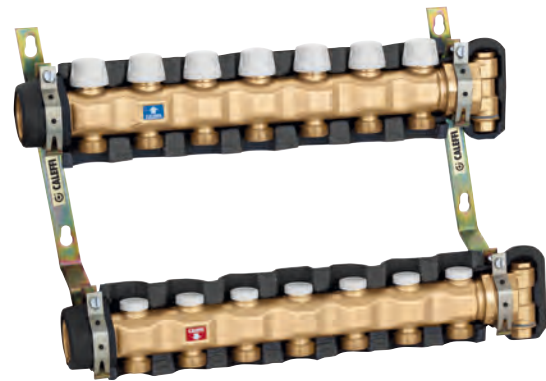

Pre-assembled distribution manifold for cooling systems.  
**With insulation.**  
 Max. working pressure: 10 bar.  
 Temperature range: 5–100 °C.  
 Outlet centre distance: 50 mm.

Consisting of:

- 1 return distribution manifold complete with shut-off valves fitted for thermo-electric actuator;
- 1 flow distribution manifold complete with lockshield valve for flow rate pre-regulation;
- 2 mounting brackets code 658100;
- 2 reduction fittings 1 1/4" M x 1" F code 364276;
- 2 double radial end fittings with plugs.



Code	Connections	Outlet No.	Outlets		
6637C5	1 1/4" x 3	3	3/4" M	1	–
6637D5	1 1/4" x 4	4	3/4" M	1	–
6637E5	1 1/4" x 5	5	3/4" M	1	–
6637F5	1 1/4" x 6	6	3/4" M	1	–
6637G5	1 1/4" x 7	7	3/4" M	1	–
6637H5	1 1/4" x 8	8	3/4" M	1	–
6637I5	1 1/4" x 9	9	3/4" M	1	–
6637L5	1 1/4" x 10	10	3/4" M	1	–
6637M5	1 1/4" x 11	11	3/4" M	1	–
6637N5	1 1/4" x 12	12	3/4" M	1	–
6637O5	1 1/4" x 13	13	3/4" M	1	–

Code	Connections	Outlet No.	Outlets		
6637C5 IS	1 1/4" x 3	3	3/4" M	1	–
6637D5 IS	1 1/4" x 4	4	3/4" M	1	–
6637E5 IS	1 1/4" x 5	5	3/4" M	1	–
6637F5 IS	1 1/4" x 6	6	3/4" M	1	–
6637G5 IS	1 1/4" x 7	7	3/4" M	1	–
6637H5 IS	1 1/4" x 8	8	3/4" M	1	–
6637I5 IS	1 1/4" x 9	9	3/4" M	1	–
6637L5 IS	1 1/4" x 10	10	3/4" M	1	–
6637M5 IS	1 1/4" x 11	11	3/4" M	1	–
6637N5 IS	1 1/4" x 12	12	3/4" M	1	–
6637O5 IS	1 1/4" x 13	13	3/4" M	1	–



DISTRIBUTION MANIFOLDS WITH SHUT-OFF AND PRE-REGULATING VALVES

1 1/4" CONNECTIONS

663

tech. broch. 01065

Pair of distribution manifolds equipped with shut-off and lockshield valves for flow rate pre-regulation. Max. working pressure: 10 bar. Temperature range: 5–100 °C. Outlet centre distance: 50 mm.



Code	Connections	Outlet No.	Outlets		
663735	1 1/4"	x 3	3/4" M	1	–
663745	1 1/4"	x 4	3/4" M	1	–
663755	1 1/4"	x 5	3/4" M	1	–
663765	1 1/4"	x 6	3/4" M	1	–
663775	1 1/4"	x 7	3/4" M	1	–
663785	1 1/4"	x 8	3/4" M	1	–

6630

tech. broch. 01065

Return distribution manifold equipped with shut-off valves, fitted for thermo-electric actuator. Max. working pressure: 10 bar. Temperature range: 5–100 °C. Outlet centre distance: 50 mm.



Code	Connections	Outlet No.	Outlets		
663030	1 1/4"	x 3	3/4" M	2	–
663040	1 1/4"	x 4	3/4" M	2	–
663050	1 1/4"	x 5	3/4" M	2	–
663060	1 1/4"	x 6	3/4" M	2	–
663070	1 1/4"	x 7	3/4" M	2	–
663080	1 1/4"	x 8	3/4" M	2	–

6631

tech. broch. 01065

Flow distribution manifold equipped with lockshield valve for flow rate pre-regulation. Max. working pressure: 10 bar. Temperature range: 5–100 °C. Outlet centre distance: 50 mm.



Code	Connections	Outlet No.	Outlets		
663130	1 1/4"	x 3	3/4" M	2	–
663140	1 1/4"	x 4	3/4" M	2	–
663150	1 1/4"	x 5	3/4" M	2	–
663160	1 1/4"	x 6	3/4" M	2	–
663170	1 1/4"	x 7	3/4" M	2	–
663180	1 1/4"	x 8	3/4" M	2	–

663

Off-centre by-pass kit with fixed setting 20 kPa (2000 mm w.g.). For pre-assembled distribution manifolds 663 series. Max. working pressure: 10 bar. Temperature range: -10–110 °C.



Code	Connections		
663000	1/2" M x 3/8" M	1	20

Full insulation (front and back) for couple manifolds 663 series.



Code	Description		
F69466	for manifolds with 3 outlets	1	–
F69467	for manifolds with 4 outlets	1	–
F69468	for manifolds with 5 outlets	1	–
F69469	for manifolds with 6 outlets	1	–
F69470	for manifolds with 7 outlets	1	–
F69471	for manifolds with 8 outlets	1	–
F69472	for manifolds with 9 outlets	1	–
F69473	for manifolds with 10 outlets	1	–
F69474	for manifolds with 11 outlets	1	–
F69475	for manifolds with 12 outlets	1	–
F69476	for manifolds with 13 outlets	1	–

391

Pair of ball valves. Female - male connections with union. With temperature gauge, scale: 0–80 °C, Ø 40 mm. Max. working pressure: 10 bar. Temperature range: 0–100 °C.



Code	Connections		
391167	1" x 1 1/4"	1	–
391177	1 1/4" x 1 1/4"	1	–

391

Pair of ball valves. Female - male connections with union. With temperature gauge connection. Max. working pressure: 10 bar. Temperature range: 0–100 °C.



Code	Connections		
391067	1" x 1 1/4"	1	–
391077	1 1/4" x 1 1/4"	1	–

THERMO-ELECTRIC ACTUATORS

6563

tech. broch. 01142



Thermo-electric actuator.  
With manual opening and position indicator.  
For distribution manifolds 662 and 663 series.  
Normally closed.  
**With auxiliary microswitch.**  
Supply: 230 V (AC) or 24 V (AC)/(DC).  
Power consumption: 3 W.  
Starting current: ≤ 1 A.  
Starting current (656344/54): ≤ 250 mA.  
Auxiliary microswitch contact rating:  
0,8 A (230 V).  
Ambient temperature range: 0–50 °C.  
Protection class: IP 40.  
Cable length: 80 cm.  
PATENT.



Code	Supply voltage V			
656312	230		1	10
656314	24		1	10
656302	230	without auxiliary microswitch	1	10
656304	24	without auxiliary microswitch	1	10

With low power consumption

Code	Supply voltage V			
656354	24		1	10
656344	24	without auxiliary microswitch	1	10

6561

tech. broch. 01042



Thermo-electric actuator.  
For distribution manifolds 662 and 663 series.  
Normally closed.  
**With auxiliary microswitch.**  
Supply: 230 V (AC) or 24 V (AC)/(DC).  
Auxiliary microswitch contact rating:  
0,8 A (230 V).  
Power consumption: 3 W.  
Starting current: ≤ 1 A.  
Ambient temperature range: 0–50 °C.  
Protection class: IP 44 (vertical stem).  
Cable length: 80 cm.



Code	Supply voltage V			
656112	230		1	10
656114	24		1	10
656102	230	without auxiliary microswitch	1	10
656104	24	without auxiliary microswitch	1	10

6562

tech. broch. 01198



Thermo-electric actuator.  
With opening position indicator.  
**Quick-coupling installation,  
with a clip adapter.**  
For distribution manifolds 662 and 663 series.  
Normally closed.  
**With auxiliary microswitch.**  
Supply: 230 V (AC) or 24 V (AC)/(DC).  
Auxiliary microswitch contact rating:  
0,8 A (230 V).  
Power consumption: 3 W.  
Starting current: ≤ 1 A.  
Ambient temperature range: 0–50 °C.  
Protection class: IP 54.  
Cable length: 80 cm.

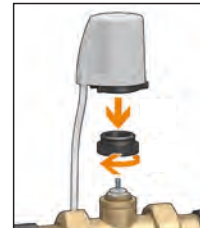

Code	Supply voltage V			
656212	230		1	10
656214	24		1	10
656202	230	without auxiliary microswitch	1	10
656204	24	without auxiliary microswitch	1	10

6564

tech. broch. 01198



Thermo-electric actuator  
with low power consumption.  
With opening position indicator.  
**Quick-coupling installation,  
with a clip adapter.**  
For distribution manifolds 662 and 663 series.  
Normally closed.  
**With auxiliary microswitch.**  
Supply: 230 V (AC) or 24 V (AC)/(DC).  
Auxiliary microswitch contact rating:  
0,8 A (230 V).  
Power consumption: 3 W.  
Starting current: ≤ 250 mA.  
Ambient temperature range: 0–50 °C.  
Protection class: IP 54.  
Cable length: 80 cm.



Code	Supply voltage V			
656412	230		1	10
656414	24		1	10
656402	230	without auxiliary microswitch	1	10
656404	24	without auxiliary microswitch	1	10

**ACCESSORIES**



**385**

Shut-off ball cock, for distribution manifold outlets. Max. working pressure: 10 bar. Max. working temperature: 100 °C. With handle.

Code			
<b>385000</b>	23 p.1,5 M x F nut	10	-



**383**

Female-female fitting.

Code			
<b>383240</b>	23 p.1,5 F x 1/2" F	10	-



**385**

Shut-off ball cock, for distribution manifold outlets. Max. working pressure: 10 bar. Max. working temperature: 100 °C. Without handle.

Code			
<b>385010</b>	23 p.1,5 M x F nut	15	150



**384**

Male fitting to nut and olive coupling.

Code			
<b>384030</b>	3/8" M x 23 p.1,5 M	10	-
<b>384040</b>	1/2" M x 23 p.1,5 M	10	-
<b>384050</b>	3/4" M x 23 p.1,5 M	10	-



**386**

Screw plug with nut for distribution manifold outlets.

Code			
<b>386000</b>	23 p.1,5	10	-



**384**

Male fitting to nut and olive coupling. Chrome plated.

Code			
<b>384031</b>	3/8" M x 23 p.1,5 M	10	-
<b>384041</b>	1/2" M x 23 p.1,5 M	10	-



**383**

Female fitting to nut and olive coupling.

Code			
<b>383030</b>	3/8" F x 23 p.1,5 M	10	-
<b>383040</b>	1/2" F x 23 p.1,5 M	10	-
<b>383050</b>	3/4" F x 23 p.1,5 M	10	-
<b>383140</b>	23 p.1,5 F x 1/2" M	10	-
<b>383150</b>	23 p.1,5 F x 3/4" M	10	-
<b>383151</b>	23 p.1,5 F x 3/4" M chrome plated	10	-



**382**

Fitting with 23 p.1,5 captive nut. Chrome plated. Max. working pressure: 10 bar. Max. working temperature: 100 °C.

Code			
<b>382000</b>	23 p.1,5 M x nut 23 p.1,5 F	10	-



**383**

Connection fitting with O-Ring seal for use with 3/4" 347, 679 and 680 series.

Code			
<b>383550</b>	3/4" M x 23 p.1,5	10	100



**383**

Adapter with flat seat with O-Ring. Transformation from 3/4" Euroconus to 3/4" flat seat.

Code			
<b>383000</b>	3/4"	1	-

**ACCESSORIES**



**392**

Temperature gauge fitting.  
For distribution manifolds 592 and 350 series.  
Temperature gauge 0–80 °C, Ø 40 mm.

Code				
<b>392600</b>	1" F x M	with PTFE seal	1	–
<b>392700</b>	1 1/4" F x M	without PTFE seal	1	–



**657**

Temperature gauge fitting.  
Temperature gauge 0–80 °C, Ø 40 mm.

Code			
<b>657400</b>	1/2" M x 1/2" F	5	–



**657**

Temperature gauge fitting.  
For distribution manifold outlets.  
Temperature gauge 0–80 °C, Ø 40 mm.

Code			
<b>657050</b>	3/4" M x 3/4" F nut	1	12



**669**

Self cleaning flow meter.  
Flow rate scale: 1–4 l/min.  
Double reading scale.  
Max. working pressure: 6 bar.  
Max. working temperature: 80 °C.  
Accuracy: ± 10 %.

Code			
<b>669050</b>	3/4" M x 3/4" F nut	1	10



**688**

Temperature gauge with pocket.  
Scale 0–80 °C.  
Ø 40 mm.

[tech. broch. 01144](#)

Code			
<b>688002</b>	1/4"	2	–



**3642**

Reduction fitting.

Code			
<b>364276</b>	1" F x 1 1/4" M	2	–



**5991**

End fitting.  
For distribution manifolds 349, 350, 592, 650 and 663 series.

Code			
<b>599153</b>	3/4" F x 3/8" F	2	–
<b>599154</b>	3/4" F x 1/2" F	2	–
<b>599163</b>	1" F x 3/8" F	2	–
<b>599164</b>	1" F x 1/2" F	2	–
<b>599173</b>	1 1/4" F x 3/8" F	2	–
<b>599174</b>	1 1/4" F x 1/2" F	2	–



**5993**

Plug.  
For distribution manifolds 349, 350, 592, 650 and 663 series.

Code			
<b>599350</b>	3/4" F	2	10
<b>599360</b>	1" F	2	10
<b>599370</b>	1 1/4" F	2	10



**5994**

Double radial end fitting.  
For distribution manifolds 349, 350, 592, 650 and 663 series.

Code			
<b>599453</b>	3/4" F x 1/2" F x 3/8" F	2	–
<b>599454</b>	3/4" F x 1/2" F x 1/2" F	2	–
<b>599463</b>	1" F x 1/2" F x 3/8" F	2	–
<b>599464</b>	1" F x 1/2" F x 1/2" F	2	–
<b>599473</b>	1 1/4" F x 1/2" F x 3/8" F	2	–
<b>599474</b>	1 1/4" F x 1/2" F x 1/2" F	2	–



**5995**

Single radial end fitting.  
For distribution manifolds 349, 350, 592, 650 and 663 series.

Code			
<b>599553</b>	3/4" F x 3/8" F	2	–
<b>599563</b>	1" F x 3/8" F	2	–
<b>599573</b>	1 1/4" F x 3/8" F	2	–



**5996**

Double radial end fitting. For distribution manifolds 662 series.

Code			
<b>599660</b>		2	–

**ACCESSORIES**



**586**

Female blind end plug.

Code			
<b>586300</b>	3/8" F	10	-
<b>586400</b>	1/2" F	10	-
<b>586600</b>	1" F	10	-



**585**

Stiffener for copper pipe with wall thickness 0,75 and 1 mm.

Code		Thickness (mm)		
<b>585010</b>	Ø 10	0,75	100	-
<b>585012</b>	Ø 12	0,75	100	-
<b>585014</b>	Ø 14	0,75	100	-
<b>585015</b>	Ø 15	0,75	100	-
<b>585016</b>	Ø 16	0,75	100	-
<b>585018</b>	Ø 18	0,75	100	-
<b>585110</b>	Ø 10	1	100	-
<b>585115</b>	Ø 15	1	100	-
<b>585116</b>	Ø 16	1	100	-
<b>585118</b>	Ø 18	1	100	-



**583**

Female compression fitting for outlets.

Code			
<b>583034</b>	3/8" F x 1/2" M - Ø 16	10	-
<b>583045</b>	1/2" F x 3/4" M - Ø 18	10	-
<b>583064</b>	1" F x 1/2" M - Ø 16	10	-
<b>583065</b>	1" F x 3/4" M - Ø 18	10	-

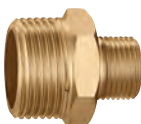

**584**

Male compression fitting for outlets.

Code			
<b>584053</b>	3/4" M x 3/8" M - Ø 12	10	-
<b>584054</b>	3/4" M x 1/2" M - Ø 16	10	-
<b>584055</b>	3/4" M x 3/4" M - Ø 18	10	-
<b>584065</b>	1" M x 3/4" M - Ø 18	10	-



**386**

Screw plug with nut for distribution manifold outlets.

Code			
<b>386500</b>	3/4"	10	-

FITTINGS 23 p.1,5



**679**  
**DARGAL**

Fitting for multilayer plastic pipe for continuous high temperature use.  
Max. working pressure: 10 bar.  
Temperature range: 0–95 °C.

For a correct use, adjust the multilayer pipe diameter before installation using the Caleffi calibrator 679 series (see page 111).

Code			
679114	23 p.1,5 - Ø 14x2	10	100
679124	23 p.1,5 - Ø 16x2	10	100
679125	23 p.1,5 - Ø 16x2,25	10	100
679144	23 p.1,5 - Ø 18x2	10	100



**680**  
**DARGAL**

Self-adjustable diameter fitting for single and multilayer plastic pipes.  
Max. working pressure: 10 bar.  
Temperature range:  
5–80 °C (PE-X)  
5–75 °C (Multilayer marked 95 °C).

Code		Ø <sub>inside</sub>	Ø <sub>outside</sub>		
680000	23 p.1,5	7,5– 8	12–14	10	100
680002	23 p.1,5	9 – 9,5	14–16	10	100
680001	23 p.1,5	9,5–10	12–14	10	100
680006	23 p.1,5	9,5–10	14–16	10	100
680015	23 p.1,5	10,5–11	14–16	10	100
680017	23 p.1,5	10,5–11	16–18	10	100
680024	23 p.1,5	11,5–12	14–16	10	100
680026	23 p.1,5	11,5–12	16–18	10	100
680035	23 p.1,5	12,5–13	16–18	10	100
680044	23 p.1,5	13,5–14	16–18	10	100



**680**  
**DARGAL**

Self-adjustable diameter fitting for single and multilayer plastic pipes.  
Max. working pressure: 10 bar.  
Temperature range:  
5–80 °C (PE-X)  
5–75 °C (Multilayer marked 95 °C).

Code		Ø <sub>inside</sub>	Ø <sub>outside</sub>		
680055	23 p.1,5	14,5–15	18–20	10	100
680064	23 p.1,5	15,5–16	18–20	10	100



**446**

Pre-assembled compression ends fitting, for annealed copper, hard copper, brass, mild steel and stainless steel pipes.  
With O-Ring seal.  
Max. working pressure: 10 bar.  
Temperature range: -25–120 °C.

Code			
446010	23 p.1,5 - Ø 10	100	–
446012	23 p.1,5 - Ø 12	100	–
446014	23 p.1,5 - Ø 14	100	–
446015	23 p.1,5 - Ø 15	100	–
446016	23 p.1,5 - Ø 16	100	–



**347**

Compression ends fitting, for annealed copper, hard copper, brass, mild steel and stainless steel pipes.  
With O-Ring seal.  
Max. working pressure: 10 bar.  
Temperature range: -25–120 °C.

Code			
347010	23 p.1,5 - Ø 10	100	–
347012	23 p.1,5 - Ø 12	100	–
347014	23 p.1,5 - Ø 14	100	–
347015	23 p.1,5 - Ø 15	100	–
347016	23 p.1,5 - Ø 16	100	–

Example: 680 series fitting selection

Known both the outside and inside diameters (ex.: 17 mm and 13 mm);  
or known the outside diameter (ex.: Øo 17 mm) and the thickness (ex.: th. 2 mm) and considering that:

$$\text{Ø}_{\text{outside}} - 2 \cdot \text{th.} = \text{Ø}_{\text{inside}}$$

$$17 - 2 \cdot 2 = 13 \text{ mm}$$

Look within the table for the code matching both diameters:

Code		Ø <sub>inside</sub>	Ø <sub>outside</sub>
680035	23 p.1,5	12,5–13	16–18

FITTINGS 3/4" - 1"



**679**  
**DARGAL**

Fitting for multilayer pipes with continuous high temperature use.  
Max. working pressure: 10 bar.  
Temperature range: 0-95 °C.

For a correct use, adjust the multilayer pipe diameter before installation using the Caleffi calibrator 679 series (see page 111).

Code			
679514	3/4" - Ø 14x2	10	100
679524	3/4" - Ø 16x2	10	100
679525	3/4" - Ø 16x2,25	10	100
679544	3/4" - Ø 18x2	10	100
679564	3/4" - Ø 20x2	10	100
679565	3/4" - Ø 20x2,25	10	100
679566	3/4" - Ø 20x2,5	10	100



**347**

Compression ends fitting, for annealed copper, hard copper, brass, mild steel and stainless steel pipes. With O-Ring seal.  
Max. working pressure: 10 bar.  
Temperature range: -25-120 °C.

Code			
347510	3/4" - Ø 10	100	-
347512	3/4" - Ø 12	100	-
347514	3/4" - Ø 14	100	-
347515	3/4" - Ø 15	100	-
347516	3/4" - Ø 16	100	-
347518	3/4" - Ø 18	10	-

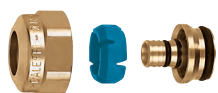

**680**  
**DARGAL**

Self-adjustable diameter fitting for single and multilayer plastic pipes.  
Max. working pressure: 10 bar.  
Temperature range:  
5-80 °C (PE-X)  
5-75 °C (Multilayer marked 95 °C).

Code		Ø <sub>inside</sub>	Ø <sub>outside</sub>		
680507	3/4"	7,5- 8	10,5-12	10	100
680502	3/4"	7,5- 8	12 -14	10	100
680503	3/4"	8,5- 9	12 -14	10	100
680500	3/4"	9 - 9,5	14 -16	10	100
680501	3/4"	9,5-10	12 -14	10	100
680506	3/4"	9,5-10	14 -16	10	100
680515	3/4"	10,5-11	14 -16	10	100
680517	3/4"	10,5-11	16 -18	10	100
680524	3/4"	11,5-12	14 -16	10	100
680526	3/4"	11,5-12	16 -18	10	100
680535	3/4"	12,5-13	16 -18	10	100
680537	3/4"	12,5-13	18 -20	10	100
680544	3/4"	13,5-14	16 -18	10	100
680546	3/4"	13,5-14	18 -20	10	100
680555	3/4"	14,5-15	18 -20	10	100
680556	3/4"	15 -15,5	18 -20	10	100
680564	3/4"	15,5-16	18 -20	10	100
680505	3/4"	17	22,5	10	100



**680**  
**DARGAL**

Compression ends fitting for multilayer pipe with fitting M-F.

Code			
680285	3/4" F - Ø 25x2,5	10	-
680296	3/4" F - Ø 26x3	10	-



**680**  
**DARGAL**

Self-adjustable diameter fitting for plastic pipes.  
Max. working pressure: 10 bar.  
Temperature range: 5-80 °C.

Code		Ø <sub>inside</sub>	Ø <sub>outside</sub>		
680687	1"	17,5	25	10	100
680605	1"	19,5	25	10	100

**PLASTIC INSPECTION WALL BOXES**



**361**

Plastic inspection wall port, with zinc plated sheet steel frame. White colour.

Code	Dim. (h x w)		
<b>361032</b>	320 x 250	1	5
<b>361050</b>	500 x 250	1	10



**360**

Plastic inspection wall box. For distribution manifolds 349, 350, 592 and 354 series. Version with foldable side walls. White colour.

Code	Dim. (h x w x d)		
<b>360032</b>	320 x 250 x 90	1	10
<b>360050</b>	500 x 250 x 90	1	10



**363**

*tech. broch. 01091*

Inspection wall port and frame in plastic. Ventilated. White colour.

Code	Dim. (h x w)		
<b>363036</b>	360 x 270	1	10
<b>363056</b>	560 x 330	1	5
<b>363073</b>	730 x 360	1	5



**362**

*tech. broch. 01091*

Plastic inspection wall box. For dual distribution manifolds 356, 357 series and single distribution manifolds 349, 350, 592 and 354 series. Ventilated. Equipped with lateral protections. Adjustable depth from 100 to 80 mm. White colour.

Code	Dim. (h x w x d)		
<b>362036</b>	360 x 270 x 100/80	1	10
<b>362056</b>	560 x 330 x 100/80	1	5
<b>362073</b>	730 x 360 x 100/80	1	5



**360**

*tech. broch. 01091*

Pair of mounting brackets for 3/4" and 1" dual distribution manifolds 356, 356 IS and 357 series. For plastic inspection boxes 360 and 362 series.

Code		
<b>360003</b>	1	-



**360**

Pair of stainless steel mounting brackets for distribution manifolds 354 series. For plastic inspection boxes 360 and 362 series.

Code		
<b>360210</b>	1	10



**360**

*tech. broch. 01091*

Mounting brackets for 1" single distribution manifolds 350 and 592 series, for 3/4" and 1" distribution manifolds 351 and 598 series. For plastic inspection boxes 360 and 362 series. In package:  
 - N. 2 long brackets  
 - N. 2 short brackets.

Code		
<b>360001</b>	1	10



**360**

*tech. broch. 01091*

Mounting brackets for 3/4" single distribution manifolds 349, 350 and 592 series. For plastic inspection boxes 360 and 362 series. In package:  
 - N. 2 long brackets  
 - N. 2 short brackets.

Code		
<b>360002</b>	1	10



**362**

*tech. broch. 01091*

Mounting brackets for dual distribution manifolds 356 and 357 series. For plastic inspection boxes 362 series.

Code		
<b>362001</b>	1	10



SHEET STEEL INSPECTION WALL BOXES



ADJUSTABLE DEPTH FROM 110 TO 140 MM



659

tech. broch. 01144

Inspection wall box for distribution manifolds 349, 350, 592, 662, 663, 671, 668...S1, 664 and 665 series.  
Wall or floor installations (with 660 series).  
Closure with a push-fit clamp.  
In painted sheet steel.  
**Adjustable depth from 110 to 140 mm.**

Code	Dim. (h x w x d)		
659044	500 x 400 x 110-140	1	-
659064	500 x 600 x 110-140	1	-
659084	500 x 800 x 110-140	1	-
659104	500 x 1000 x 110-140	1	-
659124	500 x 1200 x 110-140	1	-



ADJUSTABLE DEPTH FROM 80 - 120 MM



659

tech. broch. 01144

Inspection wall box for distribution manifolds 349, 350, 592, 662, 671, 664 and 665 series.  
Complete with specific support for manifold brackets.  
Closure with a push-fit clamp.  
In painted sheet steel.  
**Adjustable depth from 80 to 120 mm.**



Code	Dim. (h x w x d)		
659045	500 x 400 x 80-120	1	-
659065	500 x 600 x 80-120	1	-
659085	500 x 800 x 80-120	1	-
659105	500 x 1000 x 80-120	1	-



659

tech. broch. 01144

Inspection wall port with frame.  
In painted sheet steel.



Code			
659304	for 659044	1	-
659306	for 659064	1	-
659308	for 659084	1	-
659310	for 659104	1	-
659312	for 659124	1	-



659

tech. broch. 01144

Inspection wall port with frame.  
In painted sheet steel.



Code			
659504	for 659045	1	-
659506	for 659065	1	-
659508	for 659085	1	-
659510	for 659105	1	-

BRACKETS FOR INSPECTION WALL BOXES



658

Pair of mounting brackets  
592, 350 and 351 series.  
With insulating clamps, screws and wall anchors.  
To be used with boxes 659 series  
or directly wall mounted.

Code		
658000	1	20



658



Pair of mounting brackets  
for distribution manifolds 663 and 668...S1 series.  
With screws and wall anchors.  
To be used with boxes 659 series  
or directly wall mounted.

Code		
658100	1	20



658



Pair of steel mounting brackets  
for distribution manifolds 662 and 664 series.  
To be used with boxes code 659..5  
or directly wall mounted.

Code		
658101	1	-



658

Pair of mounting brackets for 3/4" and 1"  
distribution manifolds 350 and 592 series.  
With clamps and screws.  
To connect manifolds to zone valves.  
To be used with boxes 659 series.

Code		
658200	1	-



# DISTRIBUTION MANIFOLDS - DISTRIBUTION MANIFOLDS WITH REGULATING UNIT

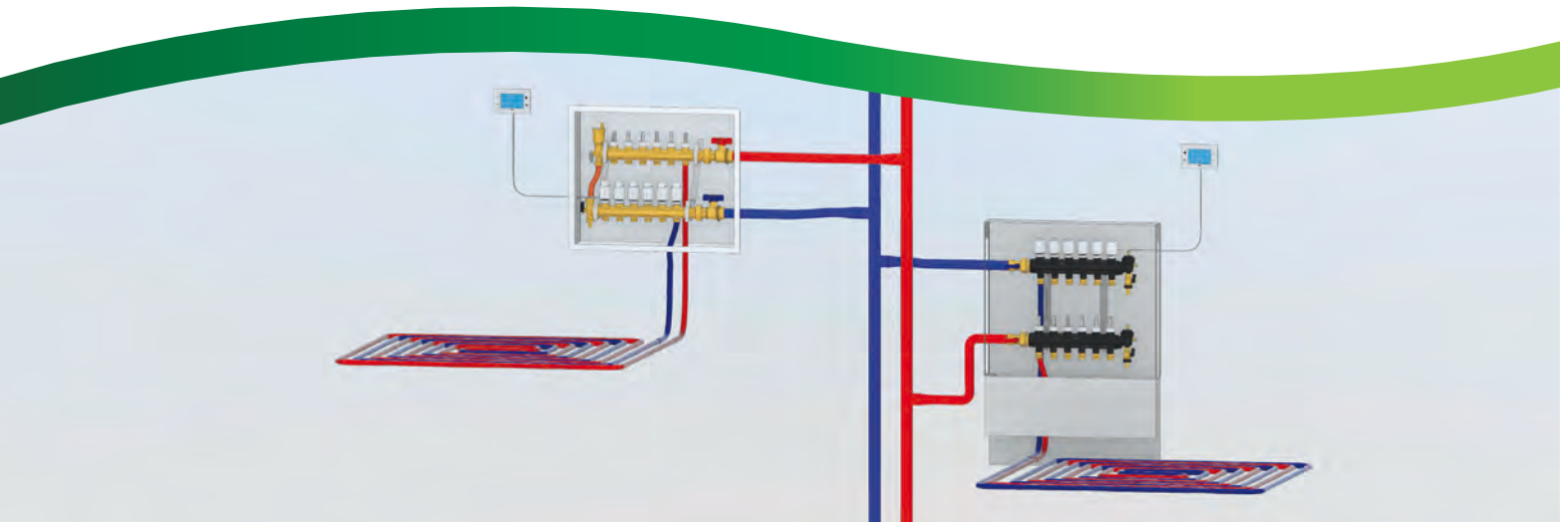

5

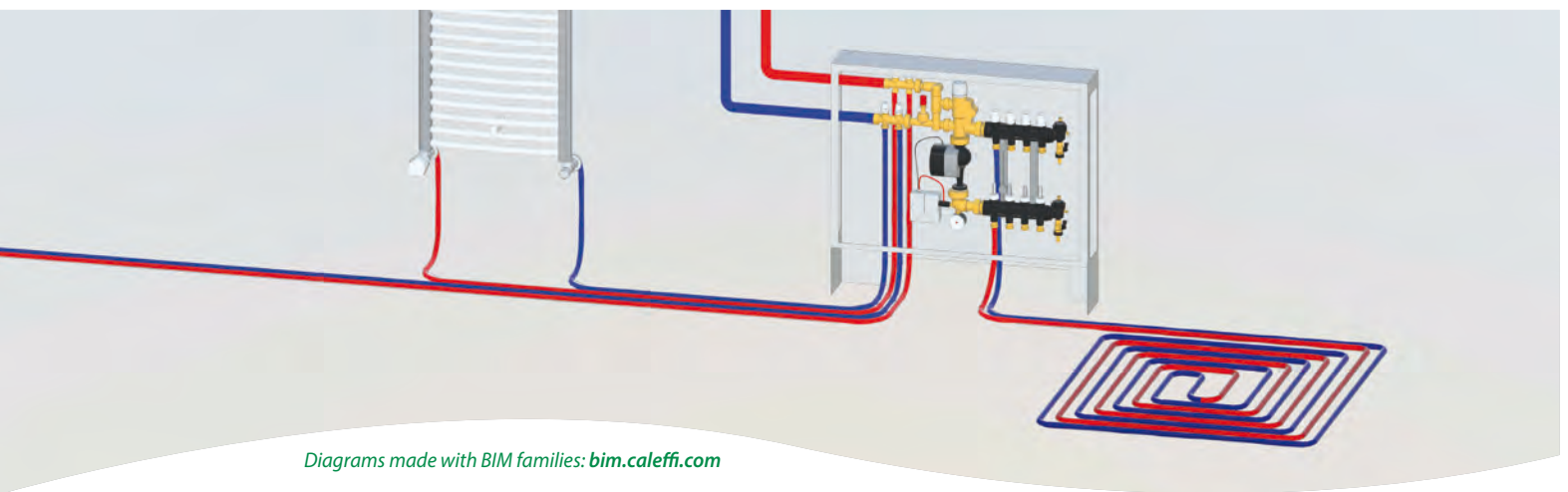

*Diagrams made with BIM families: [bim.caleffi.com](http://bim.caleffi.com)*

**Distribution manifolds for radiant panel systems**  
**Distribution manifolds with regulating unit**  
**Thermo-electric actuators and boxes for distribution manifolds**

## MANIFOLDS FOR RADIANT PANEL SYSTEMS

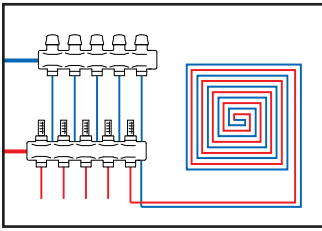

Manifolds for radiant panel systems are used for optimal distribution of the heating medium in floor heating system circuits and ultimately to improve heat emission control.

They are composed of:

- flow manifold; complete with flow meters and built-in regulating valves;
- return manifold; complete with shut-off valves with facility for thermo-electric actuator;
- end fittings complete with automatic valve and manual air vent with filler/drain cocks.

Modulating temperature regulating units or set point thermostatic regulating units can be coupled with the distribution manifolds.

### Distribution manifolds

- Technopolymer distribution manifolds
- Differential pressure control valve for distribution manifolds
- Accessories for distribution manifolds
- Brass distribution manifolds
- Dynamic distribution manifolds

### Distribution manifolds with regulating unit

- Modulating temperature regulating unit with digital temperature
- Set point thermostatic regulating unit
- Set point thermostatic regulating unit with medium distribution kit for primary circuit
- Thermostatic mixing valve for radiant panel systems

### Thermo-electric actuators and boxes for distribution manifolds

- Thermo-electric actuators
- Boxes for distribution manifolds

# DISTRIBUTION MANIFOLDS FOR RADIANT PANEL SYSTEMS

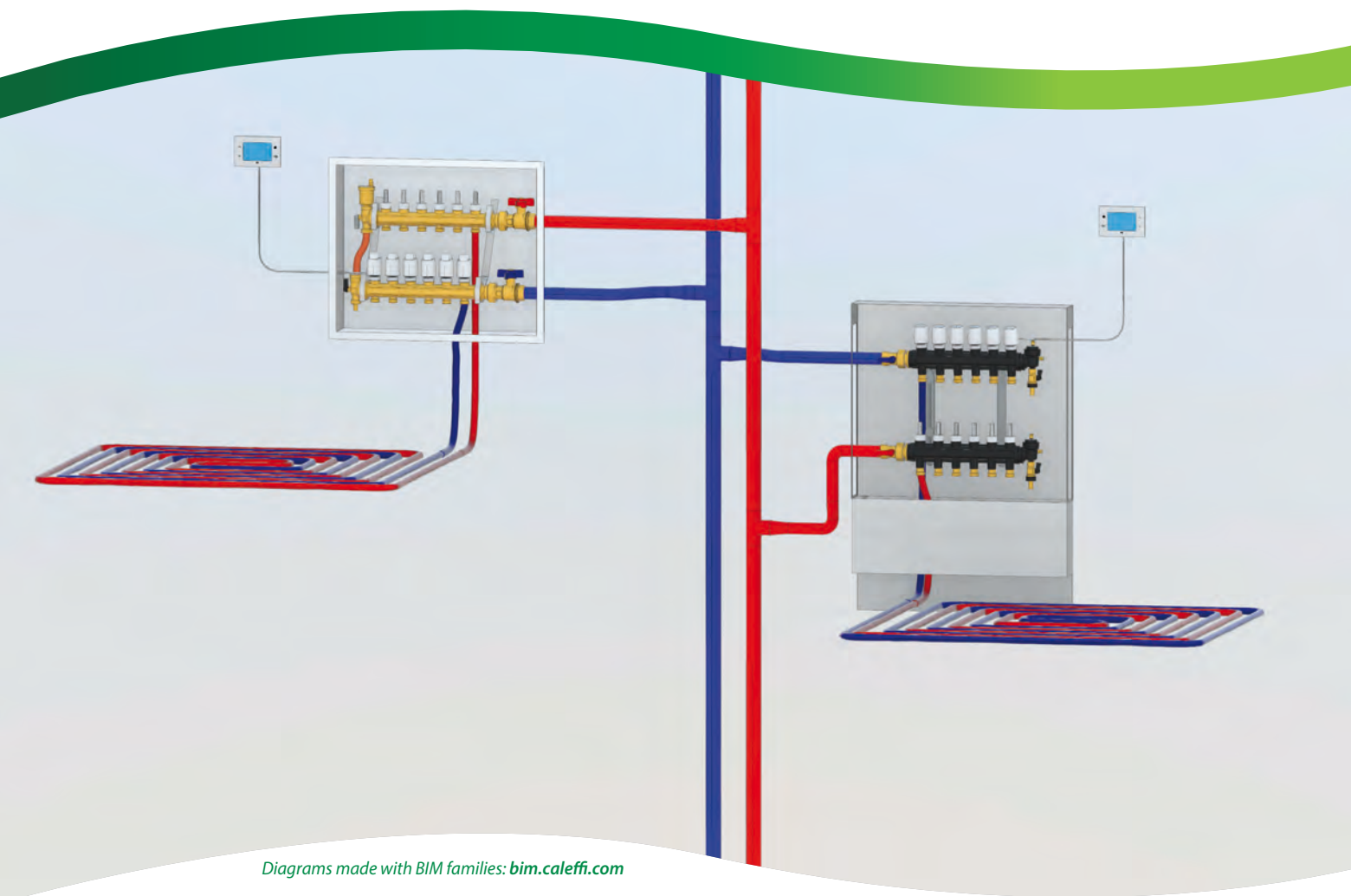

*Diagrams made with BIM families: [bim.caleffi.com](http://bim.caleffi.com)*

**Technopolymer distribution manifolds**

**Brass distribution manifolds**

**Dynamic distribution manifolds**

**Accessories for distribution manifolds**

**Changeover and distribution unit for radiant panel/fan-coil systems**

**Differential pressure control valve for distribution manifolds**

**TECHNOPOLYMER DISTRIBUTION MANIFOLDS**

**1" CONNECTIONS**





**671**

tech. broch. 01405

Pre-assembled distribution manifold.  
Max. working pressure: 6 bar.  
Temperature range: 5–60 °C.

Equipped with:

- technopolymer flow manifold with built-in flow meters and flow rate balancing valves;
- technopolymer return manifold with built-in shut-off valves fitted for thermo-electric actuator;
- technopolymer end fittings with automatic air vent with hygroscopic cap, discharge valve and fill/drain cock;
- pair of ball shut-off valves;
- LCD thermometers on flow and return manifolds;
- adhesive labels indicating the rooms;
- pair of mounting brackets for box or wall mounting;
- coupling adapter with clip code 675850, for manifold outlets (in package);
- template for cutting pipe code 675002 (in package).

Code	Connections	Outlet No.	Outlets		
6716C1	1" F x 3	3	3/4" M	1	–
6716D1	1" F x 4	4	3/4" M	1	–
6716E1	1" F x 5	5	3/4" M	1	–
6716F1	1" F x 6	6	3/4" M	1	–
6716G1	1" F x 7	7	3/4" M	1	–
6716H1	1" F x 8	8	3/4" M	1	–
6716I1	1" F x 9	9	3/4" M	1	–
6716L1	1" F x 10	10	3/4" M	1	–
6716M1	1" F x 11	11	3/4" M	1	–
6716N1	1" F x 12	12	3/4" M	1	–
6716O1	1" F x 13	13	3/4" M	1	–
6716P1	1" F x 14	14	3/4" M	1	–



**ACCESSORIES FOR TECHNOPOLYMER DISTRIBUTION MANIFOLDS**



**675**

tech. broch. 01126

Technopolymer end fitting with automatic air vent with hygroscopic cap, discharge valve, fill/drain cock.  
Max. working pressure: 6 bar.  
Temperature range: 5–60 °C.

Code			
675800	1 1/4"	1	20



**675**

tech. broch. 01126

Coupling adapter with clip.

Code			
675850	3/4" Ø 18 mm	1	40



**675**

tech. broch. 01126

Push-fit thermometer for panel piping.  
For pipes with outer diameter from 15 to 18 mm.  
Thermometer scale: 5–50 °C.  
Thermometer fluid: alcohol.  
Thermo-conductive paste supplied in package.

Code			
675900		10	100



**675**

tech. broch. 01126

Cutting pipe template.

Code			
675002		10	–



**182**

Differential by-pass kit with fixed setting 25 kPa (2.500 mm w.g.) complete with flexible hose.  
For regulating units 182 series and manifolds 670 and 671 series.  
Max. working pressure: 10 bar.  
Temperature range: 0–100 °C.

Code			
182000	3/4"	1	5

DISTRIBUTION MANIFOLDS FOR RADIANT PANEL SYSTEMS

1" CONNECTIONS



662

Pre-assembled distribution manifold.  
 Max. working pressure: 10 bar.  
 Temperature range: 5–80 °C.  
 Outlet centre distance: 50 mm.

Equipped with:

- return manifold with built-in shut-off valves fitted for thermo-electric actuator;
- flow manifold **with micrometric preregulating valves**;
- end fittings with automatic air vent and drain cock;
- polymer mounting brackets with adjustable centre distance for use with box 659 series or for direct wall mounting.





Code	Connections	Outlet No.	Outlets		
6626B6	1"	x 2	3/4" M	1	–
6626C6	1"	x 3	3/4" M	1	–
6626D6	1"	x 4	3/4" M	1	–
6626E6	1"	x 5	3/4" M	1	–
6626F6	1"	x 6	3/4" M	1	–
6626G6	1"	x 7	3/4" M	1	–
6626H6	1"	x 8	3/4" M	1	–
6626I6	1"	x 9	3/4" M	1	–
6626L6	1"	x 10	3/4" M	1	–
6626M6	1"	x 11	3/4" M	1	–
6626N6	1"	x 12	3/4" M	1	–
6626O6	1"	x 13	3/4" M	1	–

662

Pair of manifolds, with:

- return manifold with built-in shut-off valves fitted for thermo-electric actuator;
  - flow manifold **with micrometric preregulating valves**;
- Max. working pressure: 10 bar.  
 Temperature range: 5–80 °C.  
 Outlet centre distance: 50 mm.



Code	Connections	Outlet No.	Outlets		
662626	1"	x 2	3/4" M	1	–
662636	1"	x 3	3/4" M	1	–
662646	1"	x 4	3/4" M	1	–
662656	1"	x 5	3/4" M	1	–
662666	1"	x 6	3/4" M	1	–

658

tech. broch. 01180

Polymer mounting brackets with adjustable centre distance, for distribution manifolds 662 series. With screws and wall anchors. To be used with boxes code 659..4 (depth 110–140 mm) or directly wall mounted.



Code		
658400	1	5

5996

tech. broch. 01144

Return end fitting complete with automatic air vent and drain cock. Max. working pressure: 6 bar. Max. discharge pressure: 2,5 bar. Temperature range: 0–100 °C.



Code	1"		
599678	1"	1	10

5996

tech. broch. 01144

Flow end fitting complete with manual air vent and drain cock. Max. working pressure: 6 bar. Max. discharge pressure: 2,5 bar. Temperature range: 5–100 °C.



Code	1"		
599679	1"	1	10

DISTRIBUTION MANIFOLDS FOR RADIANT PANEL SYSTEMS

1" CONNECTIONS

664

tech. broch. 01260

Pre-assembled distribution manifold.  
Max. working pressure: 6 bar.  
Temperature range: 5–60 °C.  
Outlet centre distance: 50 mm.

Equipped with:

- return manifold with built-in shut-off valves fitted for thermo-electric actuator;
- flow manifold complete **with flow meters 0–5 l/m scale** and flow rate balancing valves;
- end fittings with automatic air vent and drain cock;
- steel mounting brackets for use with box or for direct wall mounting.



Code	Connections	Outlet No.	Outlets		
6646B1	1"	x 2	3/4" M	1	–
6646C1	1"	x 3	3/4" M	1	–
6646D1	1"	x 4	3/4" M	1	–
6646E1	1"	x 5	3/4" M	1	–
6646F1	1"	x 6	3/4" M	1	–
6646G1	1"	x 7	3/4" M	1	–
6646H1	1"	x 8	3/4" M	1	–
6646I1	1"	x 9	3/4" M	1	–
6646L1	1"	x 10	3/4" M	1	–
6646M1	1"	x 11	3/4" M	1	–
6646N1	1"	x 12	3/4" M	1	–
6646O1	1"	x 13	3/4" M	1	–

664

tech. broch. 01260

Pair of manifolds, with:

- return manifold with built-in shut-off valves fitted for thermo-electric actuator;
  - flow manifold complete **with flow meters 0–5 l/m scale** and flow rate balancing valves;
- Max. working pressure: 6 bar.  
Temperature range: 5–60 °C.  
Outlet centre distance: 50 mm.



Code	Connections	Outlet No.	Outlets		
664621	1"	x 2	3/4" M	1	–
664631	1"	x 3	3/4" M	1	–
664641	1"	x 4	3/4" M	1	–
664651	1"	x 5	3/4" M	1	–
664661	1"	x 6	3/4" M	1	–

658

Pair of steel mounting brackets for distribution manifolds 662 and 664 series. To be used with boxes code 659..5 or directly wall mounted.



Code		
658101	1	–

5996

tech. broch. 01144

Return end fitting complete with automatic air vent and drain cock.  
Max. working pressure: 6 bar.  
Max. discharge pressure: 2,5 bar.  
Temperature range: 0–100 °C.



Code	Connections		
599678	1"	1	10

5996

tech. broch. 01144

Flow end fitting complete with manual air vent and drain cock.  
Max. working pressure: 6 bar.  
Max. discharge pressure: 2,5 bar.  
Temperature range: 0–100 °C.



Code	Connections		
599679	1"	1	10



DYNAMIC DISTRIBUTION MANIFOLDS FOR RADIANT PANEL SYSTEMS

1" CONNECTIONS

665 DYNAMICAL®

tech. broch. 01346

Pre-assembled distribution manifold.  
 Max. working pressure: 6 bar.  
 Temperature range: 5–60 °C.  
 Outlet centre distance: 50 mm.

Equipped with:

- return manifold complete with flow adjustment valves DYNAMICAL® fitted for thermo-electric actuator, with flow rate adjustment 25–150 l/h and shut-off valves;
- flow manifold complete with flow indicators;
- end fittings with automatic air vent with hygroscopic cap and drain cock;
- steel mounting brackets for use with box or for direct wall mounting. PATENT (Dynamical cartridge).



Function

The DYNAMICAL® valve allows the **automatic dynamic balancing** and **pressure-independent adjustment** of the thermal medium in the radiators of two-pipe heating systems.

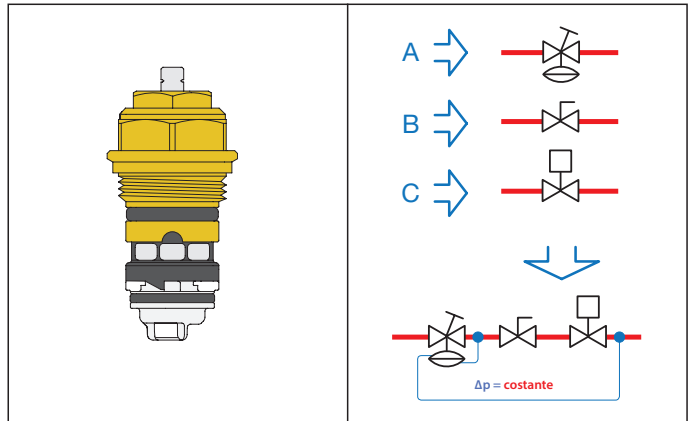

The device, in conjunction with a thermostatic, electronic or thermo-electric control, combines different functions in a single component.



**A. Differential pressure regulator**, which automatically cancels the effect of the pressure fluctuations typical of variable flow rate systems and prevents noisy operation.

**B. Device for pre-setting flow rate**, which allows direct setting of the maximum flow rate value, thanks to the combination with the differential pressure regulator.



**C. Flow rate control depending on the ambient temperature**, thanks to the combination with a thermostatic control head. The flow rate control is optimised because it is pressure-independent.

Code	Connections	Outlet No.	Outlets		
6656D1	1"	x 4	3/4" M	1	-
6656E1	1"	x 5	3/4" M	1	-
6656F1	1"	x 6	3/4" M	1	-
6656G1	1"	x 7	3/4" M	1	-
6656H1	1"	x 8	3/4" M	1	-
6656I1	1"	x 9	3/4" M	1	-
6656L1	1"	x 10	3/4" M	1	-
6656M1	1"	x 11	3/4" M	1	-
6656N1	1"	x 12	3/4" M	1	-

ACCESSORIES FOR DISTRIBUTION MANIFOLDS

Insulation for distribution manifolds  
662, 664 and 665 series.  
For heating and cooling systems.  
**For use with box code 659..4**  
**(adjustable depth from 110 to 140 mm).**



Code			
<b>CBN6646F1</b>	for manifolds from 2 to 6 outlets	1	-
<b>CBN6646N1</b>	for manifolds from 7 to 12 outlets	1	-
<b>CBN6646O1</b>	for manifolds with 13 outlets	1	-

391

Pair of ball shut-off valves with O-Ring seal.  
For distribution manifolds 664 and 665 series.



Female - male connections with union with O-Ring seal.  
Max. working pressure: 10 bar.  
Temperature range: 5-100 °C.

Code			
<b>391066</b>	1"	1	-

662

Off-centre by-pass kit with fixed setting 25 kPa (2.500 mm w.g.).  
For distribution manifolds 662, 664 and 665 series.  
Max. working pressure: 10 bar.  
Temperature range: -10-110 °C.



Code			
<b>662010</b>		1	10



680

tech. broch. 01144

DARCAL

Self-adjustable diameter fitting for single and multilayer plastic pipes.  
Max. working pressure: 10 bar.  
Temperature range:  
5-80 °C (PE-X)  
5-75 °C (Multilayer marked 95 °C).





Code		$\varnothing_{\text{inside}}$	$\varnothing_{\text{outside}}$		
<b>680507</b>	3/4"	7,5- 8	10,5-12	10	100
<b>680502</b>	3/4"	7,5- 8	12 -14	10	100
<b>680503</b>	3/4"	8,5- 9	12 -14	10	100
<b>680500</b>	3/4"	9 - 9,5	14 -16	10	100
<b>680501</b>	3/4"	9,5-10	12 -14	10	100
<b>680506</b>	3/4"	9,5-10	14 -16	10	100
<b>680515</b>	3/4"	10,5-11	14 -16	10	100
<b>680517</b>	3/4"	10,5-11	16 -18	10	100
<b>680524</b>	3/4"	11,5-12	14 -16	10	100
<b>680526</b>	3/4"	11,5-12	16 -18	10	100
<b>680535</b>	3/4"	12,5-13	16 -18	10	100
<b>680537</b>	3/4"	12,5-13	18 -20	10	100
<b>680544</b>	3/4"	13,5-14	16 -18	10	100
<b>680546</b>	3/4"	13,5-14	18 -20	10	100
<b>680555</b>	3/4"	14,5-15	18 -20	10	100
<b>680556</b>	3/4"	15 -15,5	18 -20	10	100
<b>680564</b>	3/4"	15,5-16	18 -20	10	100
<b>680505</b>	3/4"	17	22,5	10	100

386

tech. broch. 01144

Screw plug with nut, for manifold outlets.



Code			
<b>386500</b>	3/4"	10	-

675

tech. broch. 01144

Push-fit thermometer for panel piping.  
For pipes with outer diameter from 15 to 18 mm.  
Thermometer scale: 5-50 °C.  
Thermometer fluid: alcohol.  
Thermo-conductive paste supplied in package.



Code			
<b>675900</b>		10	100

CHANGEOVER AND DISTRIBUTION UNIT FOR RADIANT PANEL/FAN-COIL SYSTEMS

NEW

664

tech. broch. 01417

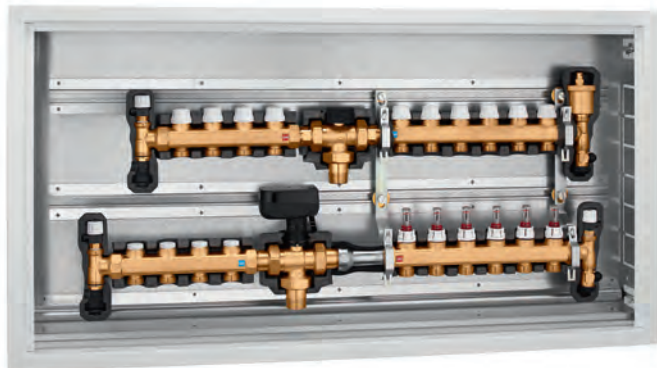

Changeover and distribution unit pre-assembled in box for radiant panel/ fan-coil systems.

Equipped with:

- distribution manifold for radiant panel systems with flow meters and shut-off valves, insulated,
- distribution manifold for fan-coil systems with lockshield valves for preset flow rate and shut-off valves, insulated,
- three-way diverter valve with three-point control, complete with insulation and anti-condensation spacer,
- check valve kit,
- box.

Max. working pressure: 6 bar.

Adjustment temperature range: 5-60 °C.

Supply: 230 V - 50/60 Hz.



Winter

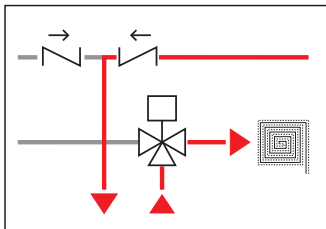

Summer

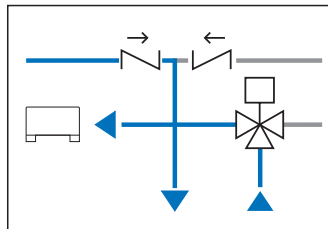

Code	Conn.	Outlet No. to panels	Outlet No. to fan-coil
6640F1	1" M	6 x 3/4" M	4 x 3/4" M
6640G1	1" M	7 x 3/4" M	4 x 3/4" M
6640H1	1" M	8 x 3/4" M	4 x 3/4" M
6640I1	1" M	9 x 3/4" M	4 x 3/4" M
6640L1	1" M	10 x 3/4" M	4 x 3/4" M
6640M1	1" M	11 x 3/4" M	4 x 3/4" M

Changeover and distribution unit dimensions for radiant panel/fan-coil systems

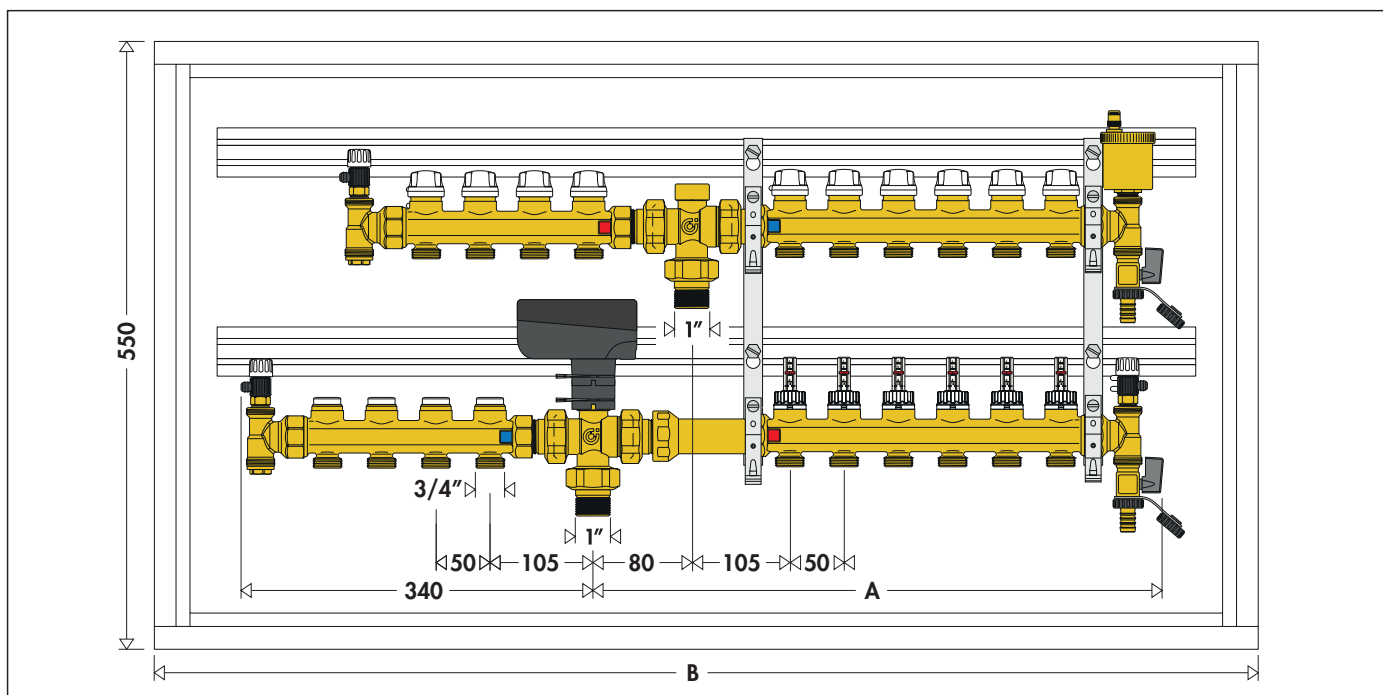

Outlet No.	4 + 6	4 + 7	4 + 8	4 + 9	4 + 10	4 + 11
A	520	570	620	670	720	770
B	1000	1000	1200	1200	1200	1200

**BRASS DISTRIBUTION MANIFOLDS FOR RADIANT PANEL SYSTEMS**

**CONNECTIONS 1" - 1 1/4"**

**668...S1**

tech. broch. 01144

Pre-assembled distribution manifold.  
Max. working pressure: 10 bar.  
Temperature range: 0–80 °C.

Equipped with:

- flow manifold with built-in flow meters and flow rate balancing valves;
- return manifold with built-in shut-off valves fitted for thermo-electric actuator;
- end fittings with multi-position ball valve, automatic air vent and fill/drain hose connection;
- off-centre by-pass kit with fixed setting and with connecting pipe;
- ball shut-off valves;
- mounting brackets for box or wall mounting.

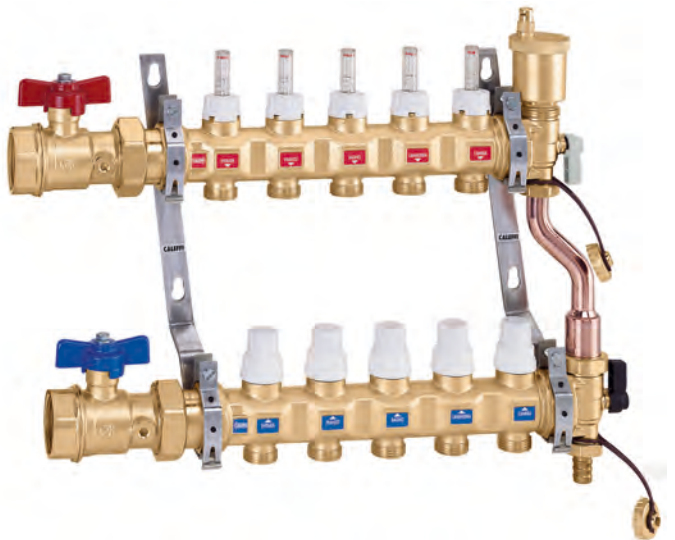

Code	Conn.	Outlet No.	Outlets		
6686C5S1	1" F	x 3	3/4" M	1	–
6686D5S1	1" F	x 4	3/4" M	1	–
6686E5S1	1" F	x 5	3/4" M	1	–
6686F5S1	1" F	x 6	3/4" M	1	–
6686G5S1	1" F	x 7	3/4" M	1	–
6686H5S1	1" F	x 8	3/4" M	1	–
6686I5S1	1" F	x 9	3/4" M	1	–
6686L5S1	1" F	x 10	3/4" M	1	–
6686M5S1	1" F	x 11	3/4" M	1	–
6686N5S1	1" F	x 12	3/4" M	1	–
6686O5S1	1" F	x 13	3/4" M	1	–
6686P5S1	1" F	x 14	3/4" M	1	–
6687C5S1	1 1/4" F	x 3	3/4" M	1	–
6687D5S1	1 1/4" F	x 4	3/4" M	1	–
6687E5S1	1 1/4" F	x 5	3/4" M	1	–
6687F5S1	1 1/4" F	x 6	3/4" M	1	–
6687G5S1	1 1/4" F	x 7	3/4" M	1	–
6687H5S1	1 1/4" F	x 8	3/4" M	1	–
6687I5S1	1 1/4" F	x 9	3/4" M	1	–
6687L5S1	1 1/4" F	x 10	3/4" M	1	–
6687M5S1	1 1/4" F	x 11	3/4" M	1	–
6687N5S1	1 1/4" F	x 12	3/4" M	1	–
6687O5S1	1 1/4" F	x 13	3/4" M	1	–
6687P5S1	1 1/4" F	x 14	3/4" M	1	–

**666...S1**

tech. broch. 01144

Return manifold, with built-in shut-off valves fitted for thermo-electric actuator.

Max. working pressure: 10 bar.  
Temperature range: 0–80 °C.  
Outlet centre distance: 50 mm.



Code	Connections	Outlet No.	Outlets		
666735S1	1 1/4" F	x 3	3/4" M	2	12
666745S1	1 1/4" F	x 4	3/4" M	2	12
666755S1	1 1/4" F	x 5	3/4" M	2	12
666765S1	1 1/4" F	x 6	3/4" M	2	–
666775S1	1 1/4" F	x 7	3/4" M	2	–
666785S1	1 1/4" F	x 8	3/4" M	2	–

**667...S1**

tech. broch. 01144

Flow manifold, with built-in flow meters and flow rate balancing valves.

Max. working pressure: 10 bar.  
Temperature range: 0–80 °C.  
Outlet centre distance: 50 mm.



Code	Connections	Outlet No.	Outlets		
667735S1	1 1/4" F	x 3	3/4" M	2	12
667745S1	1 1/4" F	x 4	3/4" M	2	12
667755S1	1 1/4" F	x 5	3/4" M	2	12
667765S1	1 1/4" F	x 6	3/4" M	2	–
667775S1	1 1/4" F	x 7	3/4" M	2	–
667785S1	1 1/4" F	x 8	3/4" M	2	–

**668...S1**

tech. broch. 01144

Pair of manifolds, with built-in flow meters and flow rate balancing valves and shut-off valves.

Max. working pressure: 10 bar.  
Temperature range: 0–80 °C.  
Outlet centre distance: 50 mm.



Code	Connections	Outlet No.	Outlets		
668735S1	1 1/4" F	x 3	3/4" M	1	6
668745S1	1 1/4" F	x 4	3/4" M	1	6
668755S1	1 1/4" F	x 5	3/4" M	1	5
668765S1	1 1/4" F	x 6	3/4" M	1	3
668775S1	1 1/4" F	x 7	3/4" M	1	3
668785S1	1 1/4" F	x 8	3/4" M	1	3

ACCESSORIES FOR DISTRIBUTION MANIFOLDS



**668...S1** tech. broch. 01144  
 Off-centre by-pass kit with fixed setting 25 kPa (2.500 mm w.g.), complete with pipe for manifold connection. For manifolds 668...S1 series.  
 Max. working pressure: 10 bar.  
 Temperature range: 0–100 °C.

Code			
<b>668000S1</b>	1" nut x 3/4" nut	1	10



**5996** tech. broch. 01144  
 Return end fitting complete with double radial end fitting with three-position ball valve, by-pass connection with plug and fill/drain hose connection.  
 Max. working pressure: 10 bar.  
 Temperature range: 0–100 °C.

Code			
<b>599675</b>	1 1/4"	1	10



**391...S1** tech. broch. 01144  
 Pair of ball shut-off valves. Female - male connections with union with O-Ring seal.  
 With temperature gauge, scale 0–80 °C, Ø 40 mm.  
 Max. working pressure: 10 bar.  
 Temperature range: 0–100 °C.

Code			
<b>391167S1</b>	1" x 1 1/4"	1	5
<b>391177S1</b>	1 1/4" x 1 1/4"	1	5



**3642..S1** tech. broch. 01144  
 Reduction fitting.

Code			
<b>364276S1</b>	1" F x 1 1/4" M	2	10



**391...S1** tech. broch. 01144  
 Pair of ball shut-off valves. Female - male connections with union with O-Ring seal.  
 With temperature gauge connection.  
 Max. working pressure: 10 bar.  
 Temperature range: 0–100 °C.

Code			
<b>391067S1</b>	1" x 1 1/4"	1	–
<b>391077S1</b>	1 1/4" x 1 1/4"	1	–



**347...S1** tech. broch. 01144  
 Compression fitting for annealed copper, hard copper, brass, mild steel and stainless steel pipes. With O-Ring seal.  
 Specific to be used with manifolds 668...S1 series.  
 Max. working pressure: 10 bar.  
 Temperature range: -25–120 °C.

Code			
<b>347512S1</b>	3/4" - Ø 12	1	50
<b>347514S1</b>	3/4" - Ø 14	1	50



**5996** tech. broch. 01144  
 Flow end fitting complete with double radial end fitting with two-position ball valve, automatic air vent and fill/drain hose connection.  
 Max. working pressure: 10 bar.  
 Max. discharge pressure: 2,5 bar.  
 Temperature range: 0–100 °C.

Code			
<b>599674</b>	1 1/4"	1	10



**5020** tech. broch. 01144  
 Automatic air vent with hygroscopic cap. In hot-stamped brass.  
 For manifolds end fittings 668...S1 series.  
 Max. working pressure: 10 bar.  
 Max. discharge pressure: 2,5 bar.  
 Max. working temperature: 110 °C.

Code			
<b>502043</b>	1/2" M	10	100



**658** tech. broch. 01144  
 Pair of brackets for use with boxes, 659 and 661 series or directly on the wall. With screws and plugs.

Code			
<b>658100</b>		1	20



## DISTRIBUTION MANIFOLDS WITH REGULATING UNIT

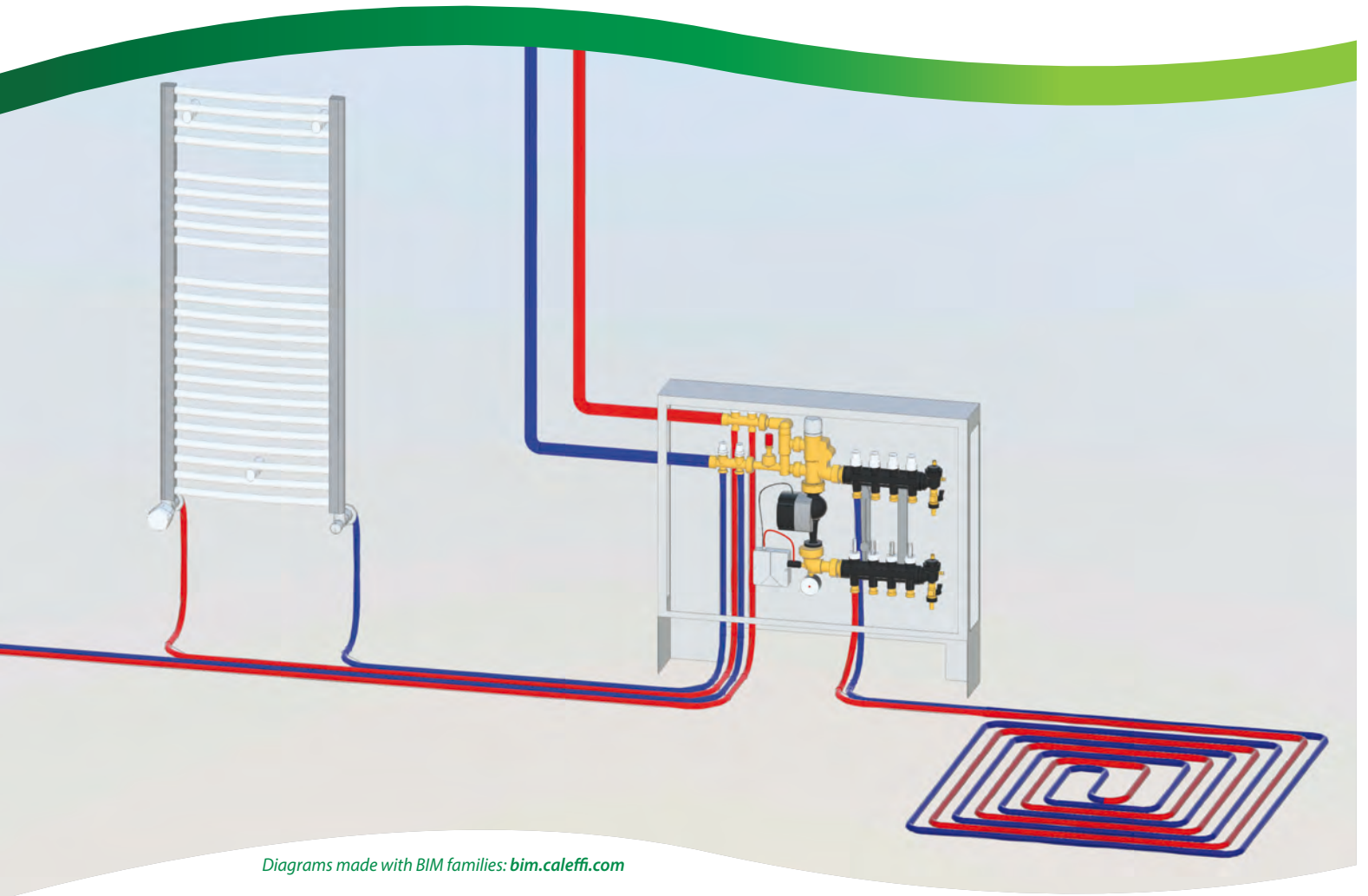

*Diagrams made with BIM families: [bim.caleffi.com](http://bim.caleffi.com)*

- Set point thermostatic regulating unit**
- Set point thermostatic regulating unit with medium distribution kit for primary circuit**
- Accessories for Set point thermostatic regulating unit**
- Modulating temperature regulating unit with digital regulator**
- Accessories and spare parts for modulating temperature regulating unit**
- Thermostatic mixing valve for radiant panel systems**

SET POINT THERMOSTATIC REGULATING UNIT

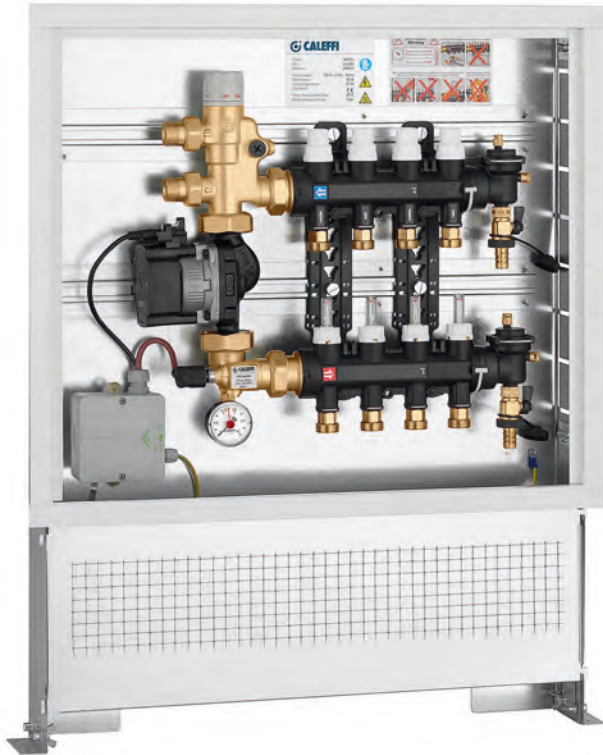

182

tech. broch. 01190

Set point regulating unit.

Pre-assembled in inspection wall box. Equipped with:



- set point thermostatic regulating unit,
- distribution manifolds in technopolymer with built-in flow meters and shut-off valves,
- safety thermostat,
- high-efficiency pump, UPM3S Auto 25-60,
- inspection wall box, with floor supports.

Max. working pressure: 6 bar.

Adjustment temperature range: 25–55 °C.

Supply: 230 V - 50/60 Hz.



Code	Conn.	Outlet No.	Outlets	Box length (mm)		
1825C1A2L	3/4" M	x 3	3/4" M	600	1	–
1825D1A2L	3/4" M	x 4	3/4" M	600	1	–
1825E1A2L	3/4" M	x 5	3/4" M	600	1	–
1825F1A2L	3/4" M	x 6	3/4" M	800	1	–
1825G1A2L	3/4" M	x 7	3/4" M	800	1	–
1825H1A2L	3/4" M	x 8	3/4" M	800	1	–
1825I1A2L	3/4" M	x 9	3/4" M	800	1	–
1825L1A2L	3/4" M	x 10	3/4" M	1000	1	–
1825M1A2L	3/4" M	x 11	3/4" M	1000	1	–
1825N1A2L	3/4" M	x 12	3/4" M	1200	1	–
1825O1A2L	3/4" M	x 13	3/4" M	1200	1	–

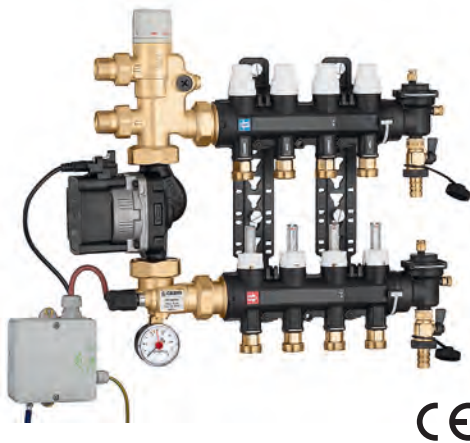

182

tech. broch. 01190

Pre-assembled set point thermostatic regulating unit.



Equipped with:

- set point thermostatic regulating unit,
- distribution manifolds in technopolymer with built-in flow meters and shut-off valves,
- safety thermostat,
- high efficiency pump, UPM3S Auto 25-60.

Max. working pressure: 6 bar.

Adjustment temperature range: 25–55 °C.

Supply: 230 V - 50/60 Hz.

Code	Conn.	Outlet No.	Outlets	Box choice (mm)		
1825C5A2L	3/4" M	x 3	3/4" M	600	1	–
1825D5A2L	3/4" M	x 4	3/4" M	600	1	–
1825E5A2L	3/4" M	x 5	3/4" M	600	1	–
1825F5A2L	3/4" M	x 6	3/4" M	800	1	–
1825G5A2L	3/4" M	x 7	3/4" M	800	1	–
1825H5A2L	3/4" M	x 8	3/4" M	800	1	–
1825I5A2L	3/4" M	x 9	3/4" M	800	1	–
1825L5A2L	3/4" M	x 10	3/4" M	1000	1	–
1825M5A2L	3/4" M	x 11	3/4" M	1000	1	–
1825N5A2L	3/4" M	x 12	3/4" M	1200	1	–
1825O5A2L	3/4" M	x 13	3/4" M	1200	1	–



## SET POINT THERMOSTATIC REGULATING UNIT WITH MEDIUM DISTRIBUTION KIT FOR PRIMARY CIRCUIT



### 182

tech. broch. 01192

Set point regulating unit.

Pre-assembled in inspection wall box. Equipped with:



- set point thermostatic regulating unit,
- medium distribution kit with built-in lockshields and shut-off valves for primary circuit,
- distribution manifolds in technopolymer with built-in flow meters and shut-off valves,
- primary circuit by-pass kit,
- safety thermostat,
- high-efficiency pump, UPM3S Auto 25-60,
- inspection wall box, with floor supports.

Max. working pressure: 6 bar.

Adjustment temperature range: 25–55 °C.

Supply: 230 V - 50/60 Hz.



Code	Conn.	Outlet No. to panels	Outlet No. to radiators	Box length (mm)		
1826C1A2L 002	1" F	3 x 3/4" M	2 x 3/4" M	800	1	-
1826D1A2L 002	1" F	4 x 3/4" M	2 x 3/4" M	800	1	-
1826E1A2L 002	1" F	5 x 3/4" M	2 x 3/4" M	800	1	-
1826F1A2L 002	1" F	6 x 3/4" M	2 x 3/4" M	1000	1	-
1826G1A2L 002	1" F	7 x 3/4" M	2 x 3/4" M	1000	1	-
1826H1A2L 002	1" F	8 x 3/4" M	2 x 3/4" M	1000	1	-
1826I1A2L 002	1" F	9 x 3/4" M	2 x 3/4" M	1000	1	-
1826L1A2L 002	1" F	10 x 3/4" M	2 x 3/4" M	1000	1	-
1826M1A2L 002	1" F	11 x 3/4" M	2 x 3/4" M	1200	1	-
1826N1A2L 002	1" F	12 x 3/4" M	2 x 3/4" M	1200	1	-
1826O1A2L 002	1" F	13 x 3/4" M	2 x 3/4" M	1200	1	-

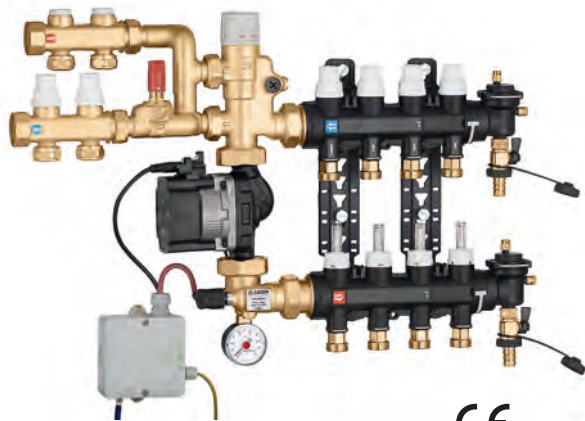

### 182

tech. broch. 01192

Pre-assembled set point regulating unit.



Equipped with:

- thermostatic set point regulating unit,
- medium distribution kit with built-in lockshields and shut-off valves for primary circuit,
- distribution manifolds in technopolymer with built-in flow meters and shut-off valves,
- primary circuit by-pass kit,
- safety thermostat,
- high-efficiency pump, UPM3S Auto 25-60.

Max. working pressure: 6 bar.

Adjustment temperature range: 25–55 °C.

Supply: 230 V - 50/60 Hz.

Code	Conn.	Outlet No. to panels	Outlet No. to radiators	Box choice (mm)		
1826C5A2L 002	1" F	3 x 3/4" M	2 x 3/4" M	800	1	-
1826D5A2L 002	1" F	4 x 3/4" M	2 x 3/4" M	800	1	-
1826E5A2L 002	1" F	5 x 3/4" M	2 x 3/4" M	800	1	-
1826F5A2L 002	1" F	6 x 3/4" M	2 x 3/4" M	1000	1	-
1826G5A2L 002	1" F	7 x 3/4" M	2 x 3/4" M	1000	1	-
1826H5A2L 002	1" F	8 x 3/4" M	2 x 3/4" M	1000	1	-
1826I5A2L 002	1" F	9 x 3/4" M	2 x 3/4" M	1000	1	-
1826L5A2L 002	1" F	10 x 3/4" M	2 x 3/4" M	1000	1	-
1826M5A2L 002	1" F	11 x 3/4" M	2 x 3/4" M	1200	1	-
1826N5A2L 002	1" F	12 x 3/4" M	2 x 3/4" M	1200	1	-
1826O5A2L 002	1" F	13 x 3/4" M	2 x 3/4" M	1200	1	-

SET POINT THERMOSTATIC REGULATING UNIT

182

Set point regulating unit.  
Pre-assembled in inspection wall box. Equipped with:

- set point thermostatic regulating unit,
- return manifold with built-in shut-off valves fitted for thermo-electric actuator;
- flow manifold complete with flow meters with 0-5 l/m scale and flow rate balancing valves;
- end fittings with automatic air vent and drain cock;
- safety thermostat,
- high-efficiency pump, UPM3S Auto 25-60,
- inspection wall box, with floor supports.

Max. working pressure: 6 bar.  
Adjustment temperature range: 25-55 °C.  
Supply: 230 V - 50/60 Hz.



Code	Conn.	Outlet No.	Outlets	Box length (mm)		
1825C7A2L	3/4" M	x 3	3/4" M	600	1	-
1825D7A2L	3/4" M	x 4	3/4" M	600	1	-
1825E7A2L	3/4" M	x 5	3/4" M	600	1	-
1825F7A2L	3/4" M	x 6	3/4" M	800	1	-
1825G7A2L	3/4" M	x 7	3/4" M	800	1	-
1825H7A2L	3/4" M	x 8	3/4" M	800	1	-
1825I7A2L	3/4" M	x 9	3/4" M	800	1	-
1825L7A2L	3/4" M	x 10	3/4" M	1000	1	-
1825M7A2L	3/4" M	x 11	3/4" M	1000	1	-
1825N7A2L	3/4" M	x 12	3/4" M	1000	1	-
1825O7A2L	3/4" M	x 13	3/4" M	1000	1	-

182

tech. broch. 01190

Pre-assembled set point regulating unit. Equipped with:

- set point thermostatic regulating unit,
- safety thermostat,
- high-efficiency pump, UPM3S Auto 25-60.

Max. working pressure: 10 bar.  
Adjustment temperature range: 25-55 °C.  
Supply: 230 V - 50/60 Hz.



Code	Connections		
182521A2L	3/4" M	1	-

182

tech. broch. 01192

Pre-assembled set point regulating unit. Equipped with:

- set point thermostatic regulating unit,
- medium distribution kit with built-in lockshields and shut-off valves for primary circuit,
- primary circuit by-pass kit,
- safety thermostat,
- high-efficiency pump, UPM3S Auto 25-60.

Max. working pressure: 10 bar.  
Adjustment temperature range: 25-55 °C.  
Supply: 230 V - 50/60 Hz.

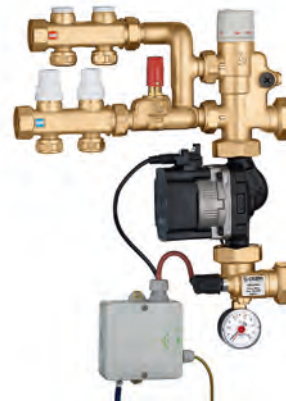

Code	Connections	Outlets		
182621A2L 002	1" F	2	1	-
182621A2L 003	1" F	3	1	-

675

Pair of fittings with seals for connection of 182 series groups to 662 and 664 series manifolds.



Code	Connections		
675005	1 1/4" M x 1" M	1	-

675

Pair of fittings with seals for connection of 182 series groups to 670 and 671 series manifolds.



Code	Connections		
675004	1 1/4" M x 1 1/4" M	1	-

Spare parts for regulating units 172 and 182 series.

Code	Description
F0000972	safety thermostat
F19153	thermostatic mixing valve group for 172 series
F19267	thermostatic mixing valve group for 182 series
F0001252	UPM3S Auto 25-60 pump
F19219	spare electronic board

ACCESSORIES FOR SET POINT THERMOSTATIC REGULATING UNIT



661

Box for manifolds 662, 671 and 668...S1 series and regulating units 182 series. Closure with a push-fit clamp. In painted sheet steel. With supports for installation on floor. Adjustable depth from 110 to 150 mm. Adjustable height from 270 a 410 mm.



182

Differential by-pass kit with fixed setting 25 kPa (2.500 mm w.g.) complete with flexible hose. For regulating units 182 series and manifolds 670 and 671 series. Max. working pressure: 10 bar. Temperature range: 0–100 °C.

Code	Dim. (h x w x d)		
661045	500 x 400 x 110–150	1	–
661065	500 x 600 x 110–150	1	–
661085	500 x 800 x 110–150	1	–
661105	500 x 1000 x 110–150	1	–
661125	500 x 1200 x 110–150	1	–

Code			
182000	3/4"	1	5

Coupling regulating units and manifolds

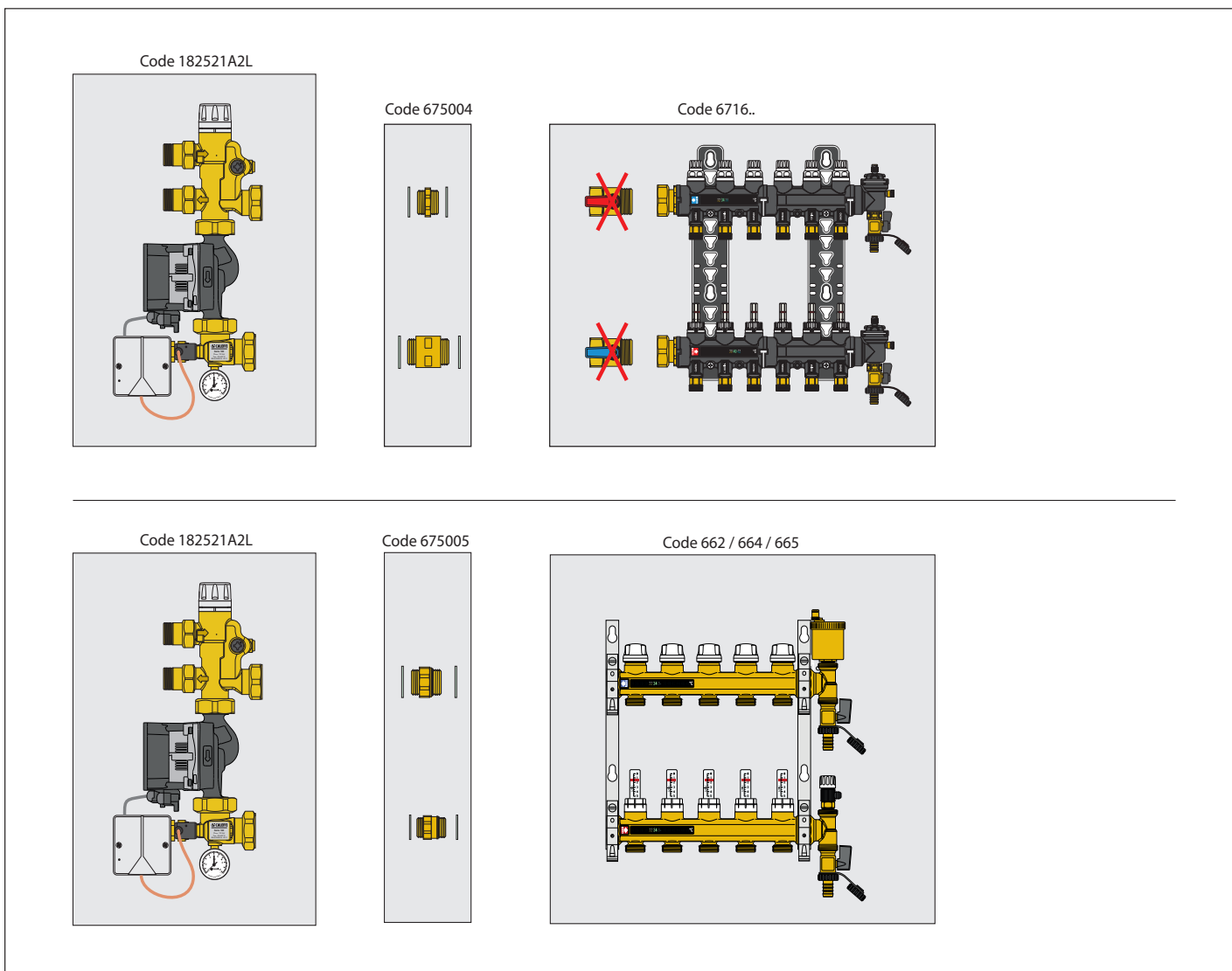

Diagram referred to installation in a box

**MODULATING TEMPERATURE REGULATING UNIT WITH DIGITAL REGULATOR**

**171**



Modulating temperature regulating unit.

Equipped with:

- temperature regulating unit with compensated set point digital regulator, convertible outside compensated,
- primary circuit by-pass kit,
- primary circuit shut-off valves,
- high-efficiency pump UPM3S Auto 25-60.

Max. working pressure: 10 bar.  
Temperature range: 5-95 °C.  
Supply: 230 V - 50/60 Hz.



Code	Connections		
171525A2L	3/4" M	1	-

**171**



Modulating temperature regulating unit.

Equipped with:

- temperature regulating unit with compensated set point digital regulator, convertible outside compensated,
- medium distribution kit with built-in lockshields and shut-off valves for primary circuit,
- primary circuit by-pass kit,
- primary circuit shut-off valves,
- high-efficiency pump UPM3S Auto 25-60.

Max. working pressure: 10 bar.  
Temperature range: 5-95 °C.  
Supply: 230 V - 50/60 Hz.



Code	Connections	Outlet no.		
171525A2L 002	3/4" M	2	1	-
171525A2L 003	3/4" M	3	1	-

**675**



Pair of fittings with seals for connection of 171 series groups to 671 series manifolds.

Code	Connections		
675003	1 1/4" M x 1" M	1	-

**364**



Pair of fittings with seals for connection of 171 series groups to 668 series manifolds.

Code	Connections		
364377		1	-



**658**

Pair of steel mounting brackets for coupling of distribution manifolds 662/664/665 and 171 series group.

Code		
658011	1	-



Pair of fittings with seals for connection of 171 series groups to 662/664/665 series manifolds.

Code		
F000062		

**661**



Box for manifolds 662, 671 and 668...S1 series and regulating units 182 series. Closure with a push-fit clamp. In painted sheet steel. With supports for installation on floor. Adjustable depth from 110 to 150 mm. Adjustable height from 270 a 410 mm.

Code	Dim. (h x w x d)		
661064	500 x 1400 x 110-150	1	-
661084	500 x 1600 x 110-150	1	-
661104	500 x 1800 x 110-150	1	-
661124	500 x 1000 x 110-150	1	-

**661**



Inspection wall port with frame. In painted sheet steel.

tech. broch. 01144

Code	Use		
661406	for 661064	1	-
661408	for 661084	1	-
661410	for 661104	1	-
661412	for 661124	1	-

Coupling regulating units and manifolds

Code 171525A2L

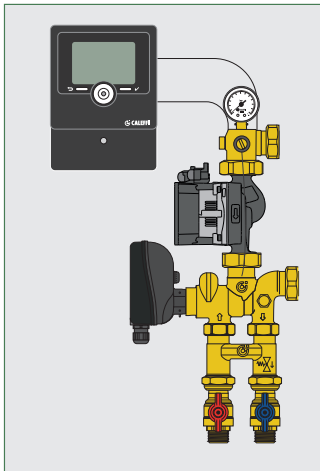

Code 675003



Code 6716..

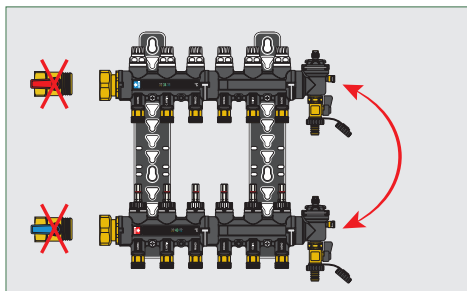

Code 171525A2L

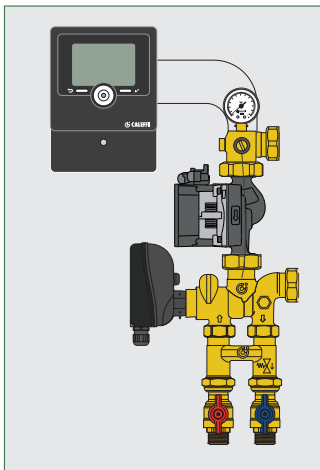

Code F0000662



Code 662 / 664 / 665

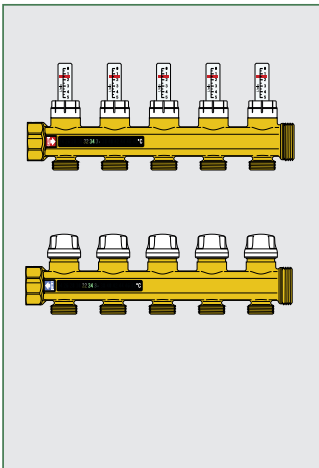

Code 599678

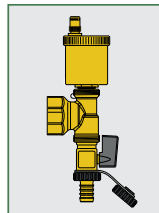

Code 658011

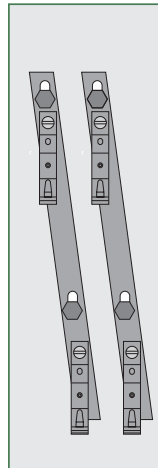

Code 599679

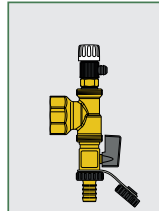

Code 171525A2L

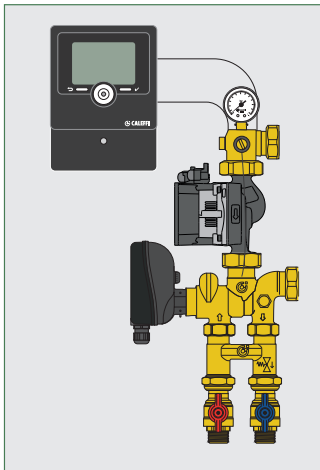

Code 364377



Code 668...S1

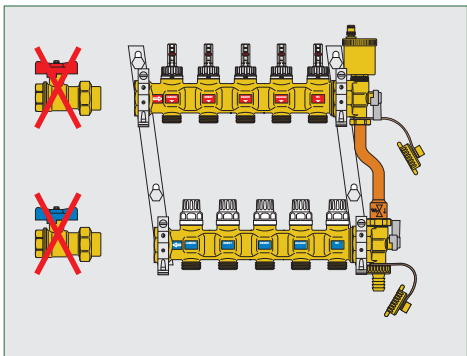

Diagram referred to installation in a box

**ACCESSORIES AND SPARE PARTS  
FOR MODULATING TEMPERATURE REGULATING UNIT**



**161**  
Outside compensated temperature probe.

Code		
<b>161002</b>	1	-



**161**  
Pressure safety switch complete with cable for wiring.  
Working range: 0,5–10 bar.  
Max. working temperature: 100 °C.  
Cable length: 1 m.

Code		
<b>161003</b>	1	-



**161**  
Dew point detector.  
Working range: 30–100 UR %.

Code		
<b>161004</b>	1	-



**161**  
Remote regulator.  
Functions:  
- translation of the regulating curves, from +15 K to -15 K,  
- maximum temperature,  
- OFF position.

Code		
<b>161005</b>	1	-

Accessories for regulator code 161010.

Code	
<b>161012</b>	Pt1000 contact probe for pipes Ø 6 mm, cable L 2,5 m
<b>161013</b>	immersion pocket for Pt1000 probe 1/2" M, 60 mm
<b>161014</b>	immersion pocket for Pt1000 probe 1/2" M, 100 mm
<b>161015</b>	Pt1000 probe Ø 6 mm - L 20 mm, cable L 1,5 m
<b>161006</b>	Pt1000 probe Ø 6 mm - L 45 mm, cable L 2,5 m

Spare parts for regulating units code 1715.5A2L.

Code	
<b>161010</b>	digital regulator
<b>F19223</b>	mixing valve group with actuator support
<b>645312</b>	actuator for mixing valve for code 1715.5A2L
<b>F0001252</b>	UPM3S pump (to replace the UPM3 Auto L pump)
<b>F0000560</b>	pocket 1/8" Ø 6 mm for probe Pt1000 L 20 mm
<b>161015</b>	probe Pt1000 Ø 6 mm - L 20 mm, L cable 1,5 m

Application diagram with code 161003

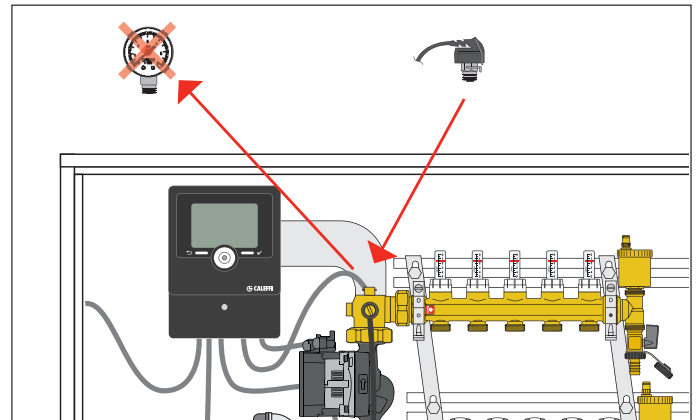

Application diagram with code 161005

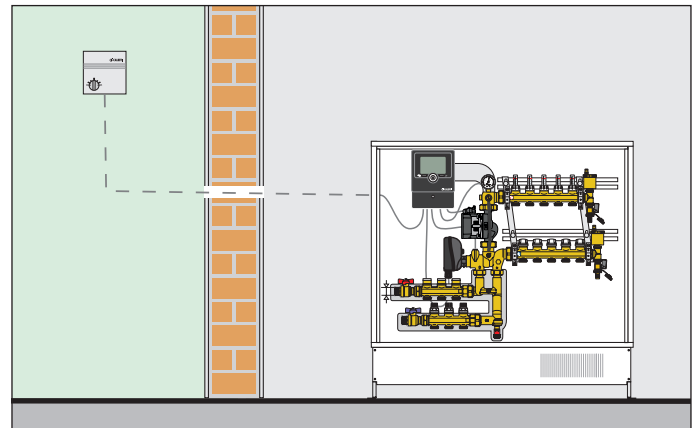

Transformation from modulating for heating to compensated temperature for heating and cooling with codes 161002 and 161004

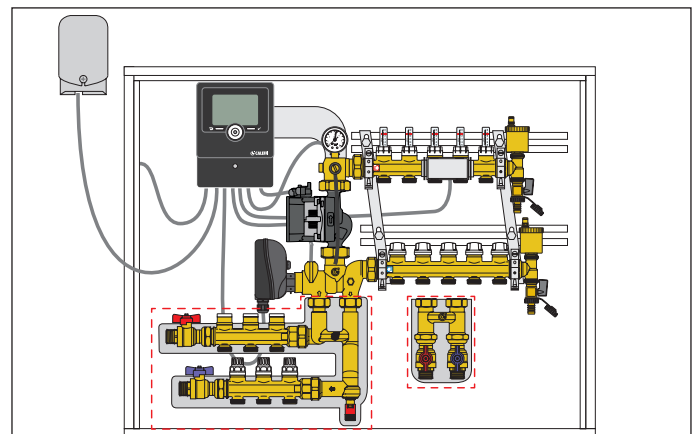

**THERMOSTATIC MIXING VALVE FOR RADIANT PANEL SYSTEMS**



**5202**



Adjustable thermostatic mixing valve with knob.  
For radiant panel systems.  
CR dezincification resistant alloy body.  
Max. working pressure: 10 bar.  
Max. inlet temperature: 90 °C.

**Operating principle**

The purpose of the thermostatic mixing valve is to adjust the temperature of the medium supplied to the radiant panels.  
The thermostatic mixing valve mixes the hot and cold water at the inlet so as to maintain the mixed water constantly at the set temperature at the outlet. A thermostatic element is fully immersed in the mixed water flow. It contracts or expands, moving an obturator which controls the passage of hot or cold water at the inlet. If the inlet temperature changes, the internal element automatically reacts to restore the set temperature at the outlet. A circulator must be installed downstream of the mixing valve so as to allow correct distribution of the medium at the radiant panel system manifold.

Code	DN	Conn.	Temperature adjustment	Kv (m <sup>3</sup> /h)		
520251	20	3/4" M	20-43 °C	1,4	1	10
520261	25	1" M	20-43 °C	4	1	5

Application diagram of mixing valve 5202 series

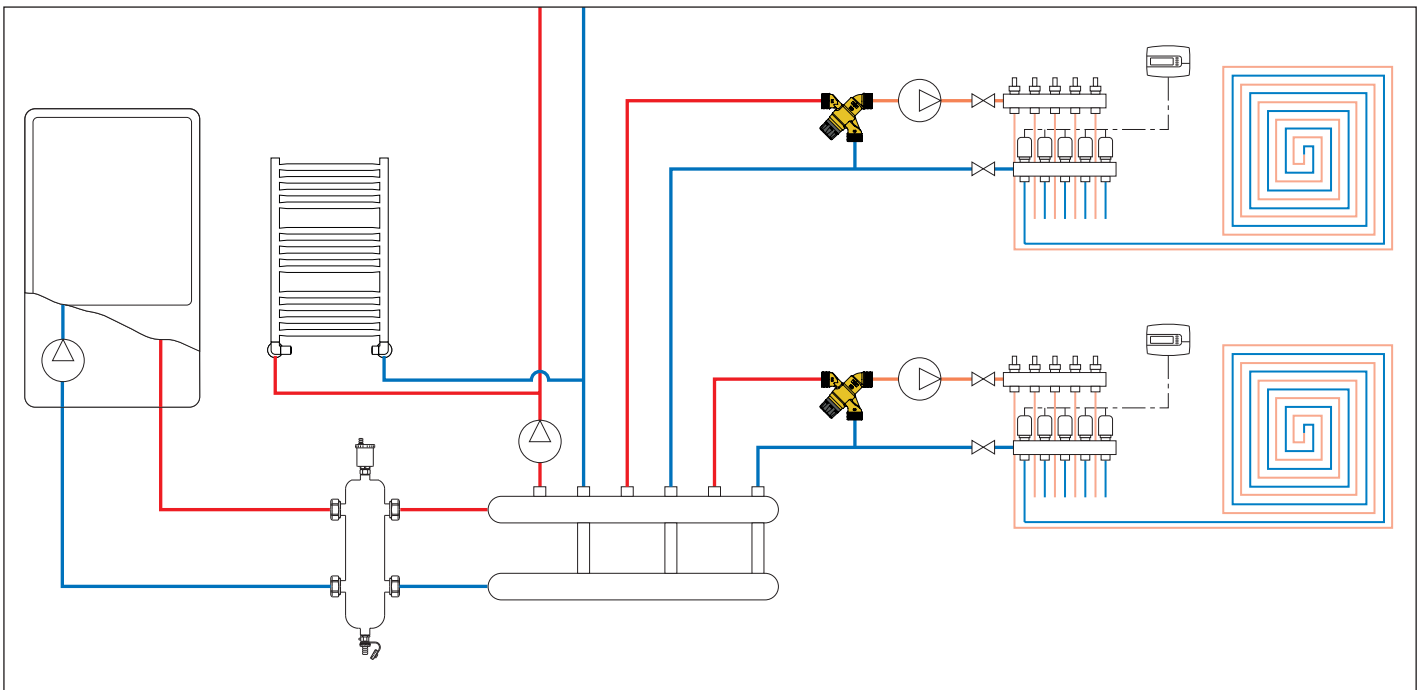





# THERMO-ELECTRIC ACTUATORS AND BOXES FOR DISTRIBUTION MANIFOLD

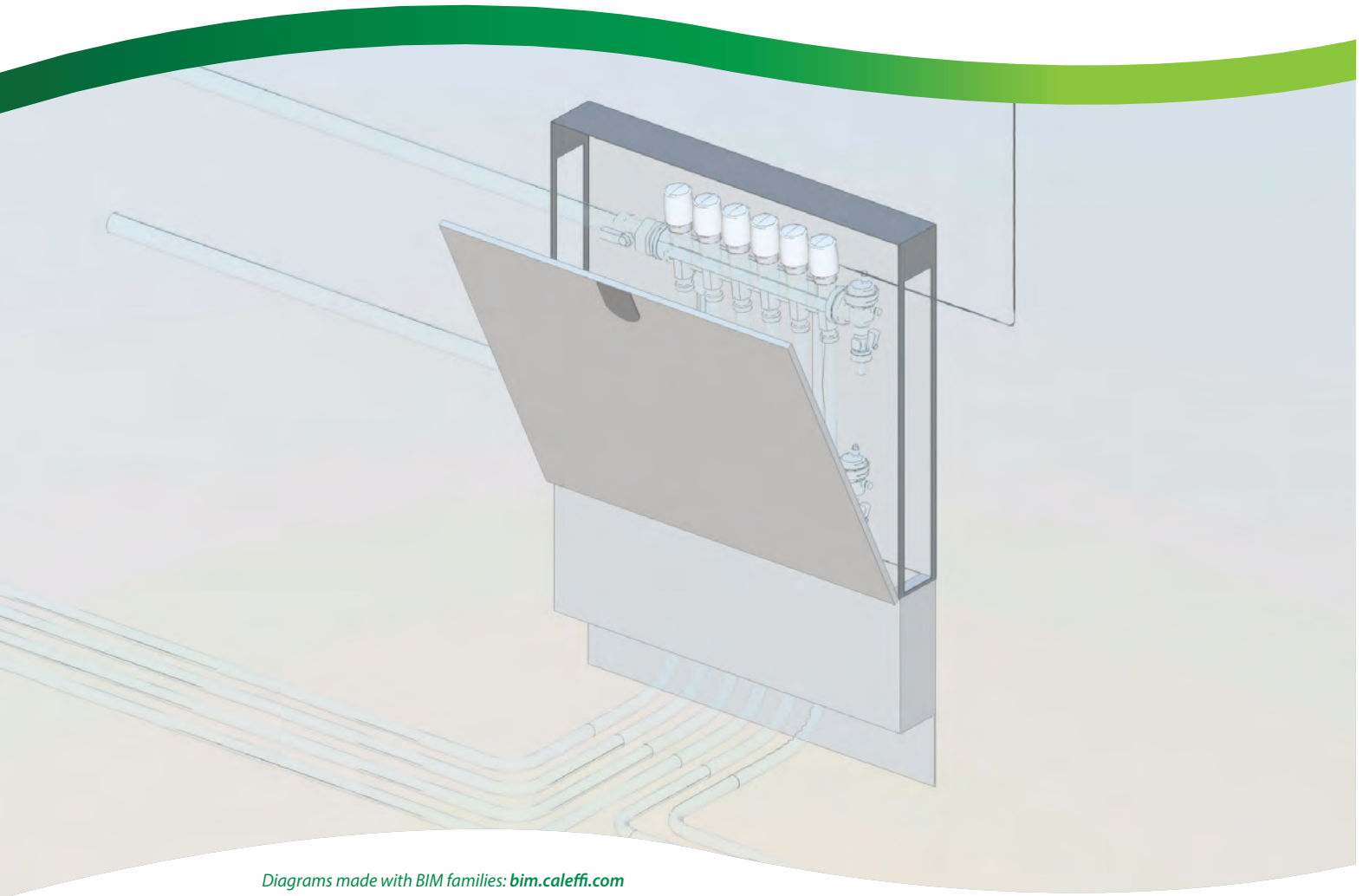

*Diagrams made with BIM families: [bim.caleffi.com](http://bim.caleffi.com)*

**Thermo-electric actuators**  
**Boxes for distribution manifolds**

THERMO-ELECTRIC ACTUATORS



6563

tech. broch. 01142

Thermo-electric actuator. With manual opening and position indicator. For distribution manifolds 670, 671, 668...S1, 6626.6, 664 and 665 series. Normally closed. **With auxiliary microswitch.** Supply: 230 V (AC) or 24 V (AC)/(DC). Power consumption: 3 W. Starting current: ≤ 1 A. Starting current (656344/54): ≤ 250 mA. Auxiliary microswitch contact rating: 0,8 A (230 V). Ambient temperature range: 0–50 °C. Protection class: IP 40. Cable length: 80 cm. PATENT.

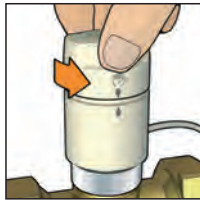

Code	Supply voltage V			
656312	230		1	10
656314	24		1	10
656302	230	without auxiliary microswitch	1	10
656304	24	without auxiliary microswitch	1	10

With low power consumption

Code	Supply voltage V			
656354	24		1	10
656344	24	without auxiliary microswitch	1	10



6561

tech. broch. 01042

Thermo-electric actuator. For distribution manifolds 670, 671, 668...S1, 6626.6, 664 and 665 series. Normally closed. **With auxiliary microswitch.** Supply: 230 V (ac) or 24 V (ac)/(dc). Auxiliary microswitch contact rating: 0,8 A (230 V). Power consumption: 3 W. Starting current: ≤ 1 A. Max. ambient temperature: 50 °C. Protection class: IP 44 (vertical stem). Cable length: 80 cm.



Code	Supply voltage V			
656112	230		1	10
656114	24		1	10
656102	230	without auxiliary microswitch	1	10
656104	24	without auxiliary microswitch	1	10



6562

tech. broch. 01198

Thermo-electric actuator. With opening position indicator. **Quick-coupling installation, with a clip adapter.** For distribution manifolds 670, 671, 668...S1, 6626.6, 664 and 665 series. Normally closed. **With auxiliary microswitch.** Supply: 230 V (AC) or 24 V (AC)/(DC). Auxiliary microswitch contact rating: 0,8 A (230 V). Power consumption: 3 W. Starting current: ≤ 1 A. Ambient temperature range: 0–50 °C. Protection class: IP 54. Cable length: 80 cm.

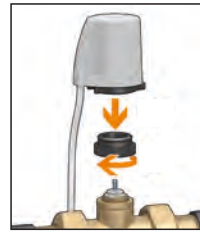

Code	Supply voltage V			
656212	230		1	10
656214	24		1	10
656202	230	without auxiliary microswitch	1	10
656204	24	without auxiliary microswitch	1	10

6564

tech. broch. 01198

Thermo-electric actuator with low power consumption. With opening position indicator. **Quick-coupling installation, with a clip adapter.** For distribution manifolds 670, 671, 668...S1, 6626.6, 664 and 665 series. Normally closed. **With auxiliary microswitch.** Supply: 230 V (AC) or 24 V (AC)/(DC). Auxiliary microswitch contact rating: 0,8 A (230 V). Power consumption: 3 W. Starting current: ≤ 250 mA. Ambient temperature range: 0–50 °C. Protection class: IP 54. Cable length: 80 cm.



Code	Supply voltage V			
656412	230		1	10
656414	24		1	10
656402	230	without auxiliary microswitch	1	10
656404	24	without auxiliary microswitch	1	10

6205

tech. broch. 01186

Control bar. Supply: 230 V - 50/60 Hz. Power consumption: 5,5 VA max (8 outputs). Changeover contacts: 10 A. Protection class: IP 30 (with rubber cable clamps). Output command for pump. Input for SUMMER - WINTER. Input for timer.



Code			
620542	4 channels	1	-
620582	8 channels	1	-

BOXES FOR DISTRIBUTION MANIFOLDS



ADJUSTABLE DEPTH FROM 110 TO 140 MM



659

tech. broch. 01144

Inspection wall box for distribution manifolds 349, 350, 592, 662, 663, 671, 668...S1, 664 and 665 series.  
Wall or floor installations (with 660 series).  
Closure with a push-fit clamp.  
In painted sheet steel.  
**Adjustable depth from 110 to 140 mm.**

Code	Dim. (h x w x d)		
659044	500 x 400 x 110-140	1	-
659064	500 x 600 x 110-140	1	-
659084	500 x 800 x 110-140	1	-
659104	500 x 1000 x 110-140	1	-
659124	500 x 1200 x 110-140	1	-



ADJUSTABLE DEPTH FROM 80 TO 120 mm



659

tech. broch. 01144

Inspection wall box for distribution manifolds 349, 350, 592, 662, 671, 664 and 665 series.  
Complete with specific support for manifold brackets.  
Closure with a push-fit clamp.  
In painted sheet steel.  
**Adjustable depth from 80 to 120 mm.**



Code	Dim. (h x w x d)		
659045	500 x 400 x 80-120	1	-
659065	500 x 600 x 80-120	1	-
659085	500 x 800 x 80-120	1	-
659105	500 x 1000 x 80-120	1	-



659

tech. broch. 01144

Inspection wall port with frame.  
In painted sheet steel.



Code			
659304	for 659044	1	-
659306	for 659064	1	-
659308	for 659084	1	-
659310	for 659104	1	-
659312	for 659124	1	-



659

tech. broch. 01144

Inspection wall port with frame.  
In painted sheet steel.



Code			
659504	for 659045	1	-
659506	for 659065	1	-
659508	for 659085	1	-
659510	for 659105	1	-



660

tech. broch. 01144

Floor installation kit for box 659 series.  
Consisting of:  
- 2 supports height cm. 20,  
- 2 side panels,  
- 1 pipe-bending bar.

Code			
660040	for 659044	1	-
660060	for 659064	1	-
660080	for 659084	1	-
660100	for 659104	1	-
660120	for 659124	1	-



ADJUSTABLE DEPTH FROM 110 - 150 mm



661

tech. broch. 01144

Box for manifolds 662, 671, 668...S1, 664 and 665 series and regulating units 182 series.  
With supports for installation on floor.  
Closure with a push-fit clamp.  
In painted sheet steel.  
Adjustable depth from 110 to 150 mm.  
Adjustable height from 270 to 410 mm.

Code	(h x w x d)		
661045	500 x 400 x 110-150	1	-
661065	500 x 600 x 110-150	1	-
661085	500 x 800 x 110-150	1	-
661105	500 x 1000 x 110-150	1	-
661125	500 x 1200 x 110-150	1	-



# COMPONENTS FOR DOMESTIC WATER SYSTEMS

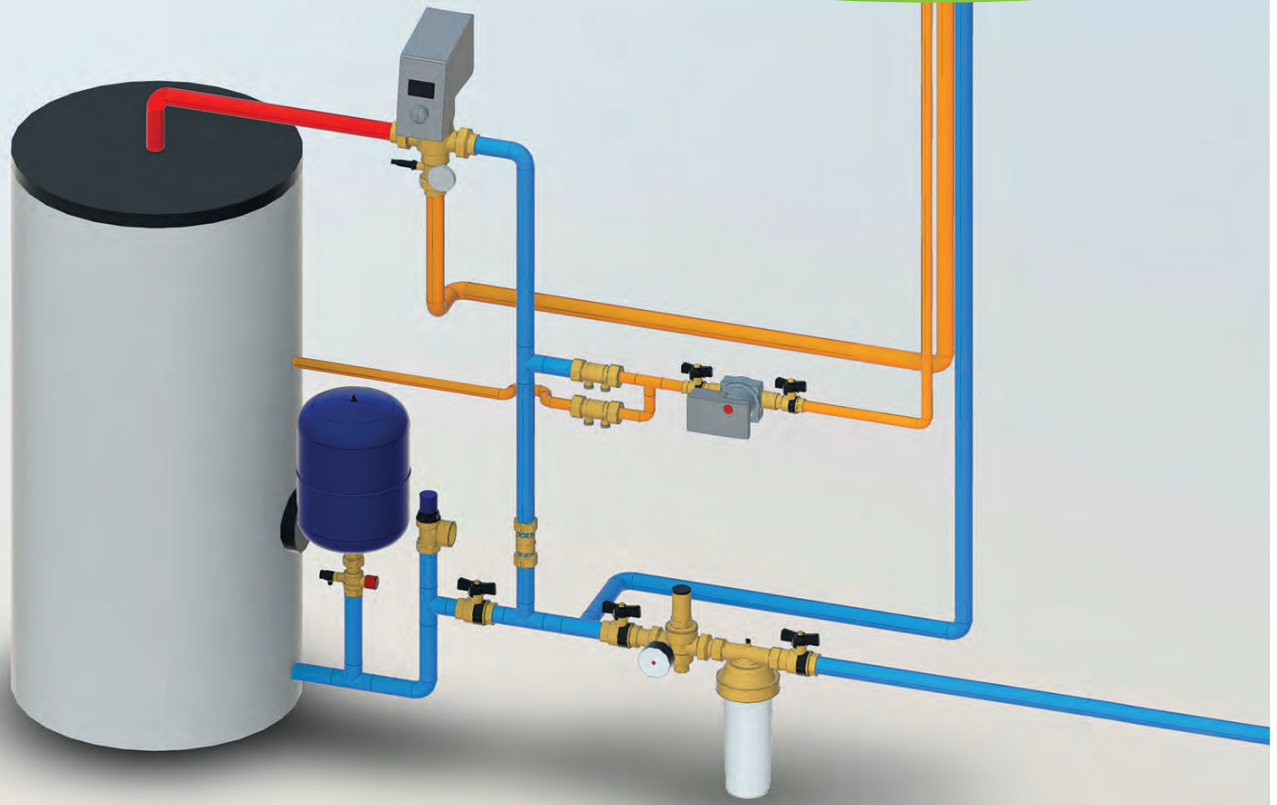

*Diagrams made with BIM families: [bim.caleffi.com](http://bim.caleffi.com)*

**Pressure reducing valves**  
**Thermostatic mixing valves**  
**Manifolds for domestic water systems**  
**Components for domestic water systems**

## COMPONENTS FOR DOMESTIC WATER SYSTEMS

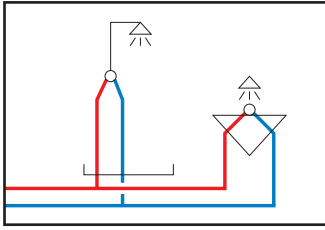

Modern domestic cold and hot water distribution systems need special protective and control devices, which are chosen according to the intended use and security level to be guaranteed for the utilities. Depending on the application type, for example home, commercial or public use, different rules are used to dimension systems, and they are fitted with different equipment. Below we describe the most important device classifications to help make the right choice.

### Pressure adjustment

- Pressure reducing valves

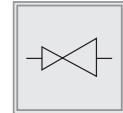

### Temperature adjustment

- Thermostatic and electronic mixing valves

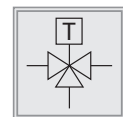

### Flow rate adjustment

- Thermostatic regulator for recirculation circuits

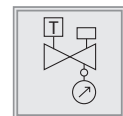

### Cold and hot water distribution

- Distribution manifolds

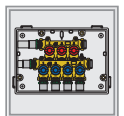
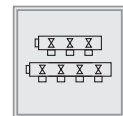

### Safety and protection of hot water storage

- Safety groups - Safety valves - Expansion vessels

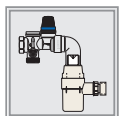
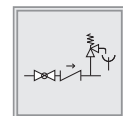

### Water hammer phenomenon

- Water hammer arrester

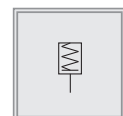

### Antifreeze protection

- Shut-off cock with antifreeze safety device

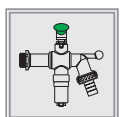

### Shut off medium

- Ball valves with built-in check valve

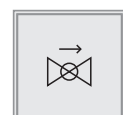

# PRESSURE REDUCING VALVES

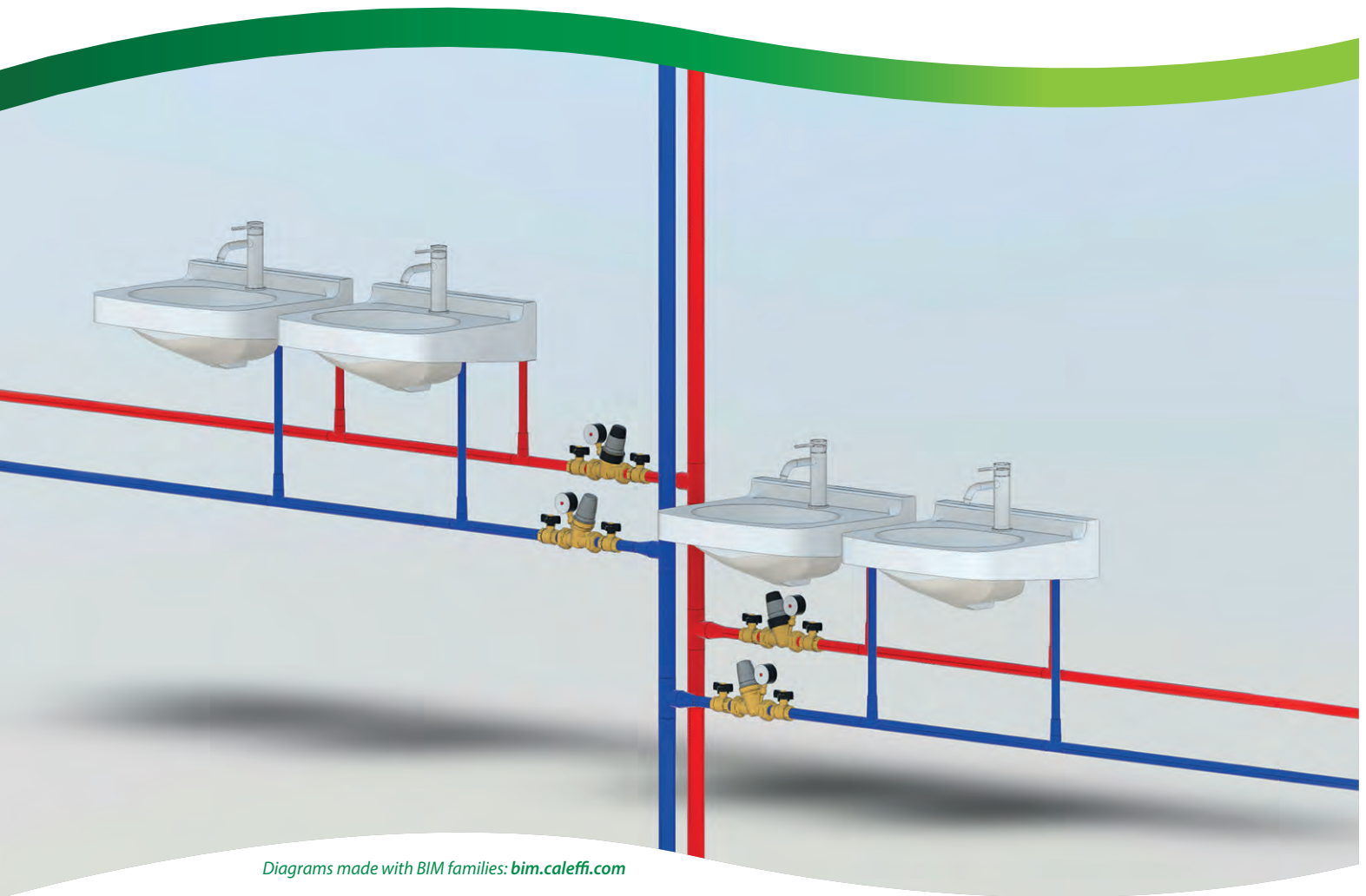

*Diagrams made with BIM families: [bim.caleffi.com](http://bim.caleffi.com)*

**Pressure reducing valves**  
**Pressure reducing and stabilising valves**  
**Combined group for pressure control in domestic water systems**



**Domestic Water Sizer**



**DOMESTIC WATER SYSTEM SIZER ALSO FOR SMARTPHONE**

Available on [www.caleffi.com](http://www.caleffi.com) and app for smartphone.

Download the version for your iOS and Android® mobile phone.

INCLINED MICRO PRESSURE REDUCING VALVE FOR SPECIAL APPLICATIONS



533...H

tech. broch. 01332

Inclined micro pressure reducing valve for special applications: **for dispensing water, beverages and coffee machines.**

Replaceable cartridge and strainer. CR dezincification resistant alloy body "LOW LEAD".

Max. upstream pressure: 16 bar.  
Downstream pressure setting range: 0,8–4 bar.  
Max. working temperature: 80 °C.  
Max. recommended flow rate: 6 l/min.  
**Certified to EN 1567.**  
PATENT PENDING.



Code	DN	Connection		
533430H	8	3/8"	1	20
533230H	8	3/8" with pressure gauge 0–10 bar	1	20
Code				
F0002665		pressure gauge 0–10 bar	1	–

Applications

The 533...H series of micro pressure reducing valves has been specially created for applications where it is necessary to reduce and precisely stabilise the pressure arriving from the mains in the presence of low flow rate values. The 533...H series is typically installed for service in appliances that also have important dimensions and intermittent operation. The performance of this series of micro pressure reducing valves complies with the requirements of standard EN 1567, for use with cold water and hot water up to 80 °C.

**The typical applications of these micro pressure reducing valves are appliances for dispensing water, beverages and coffee machines.**

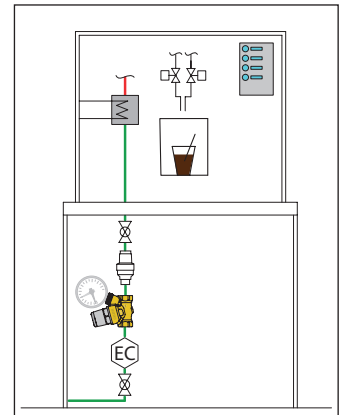
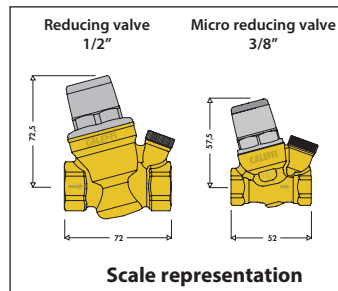

INCLINED PRESSURE REDUCING VALVES



533

tech. broch. 01024

Inclined pressure reducing valve. Replaceable cartridge and strainer. Brass body. Chrome plated. Max. upstream pressure: 16 bar. Downstream pressure setting range: 1–6 bar. Max. working temperature: 40 °C.



Code	DN	Connection		
533041	1/2"		1	20
533051	3/4"		1	20



5332

tech. broch. 01024

Inclined pressure reducing valve. Replaceable cartridge and strainer. Brass body. Chrome plated. Max. upstream pressure: 16 bar. Downstream pressure setting range: 1–6 bar. Max. working temperature: 40 °C. With pressure gauge: 0–10 bar.



Code	DN	Connection		
533241	1/2"		1	20
533251	3/4"		1	20



5331

tech. broch. 01024

Inclined pressure reducing valve for safety group. Replaceable cartridge and strainer. Brass body. Chrome plated. Max. upstream pressure: 16 bar. Downstream pressure setting range: 1–6 bar. Max. working temperature: 40 °C.



Code	DN	Connection		
533151	3/4" M	x nut 3/4" F	1	25



5334

tech. broch. 01024

Inclined pressure reducing valve. Replaceable cartridge and strainer. Brass body. Chrome plated. Max. upstream pressure: 16 bar. Downstream pressure setting range: 1–6 bar. Max. working temperature: 40 °C. With 1/4" F pressure gauge connection.



Code	DN	Connection		
533441	1/2"		1	20
533451	3/4"		1	20
533461	1"		1	25



**INCLINED PRESSURE REDUCING VALVES**



**5336**

[tech. broch. 01024](#)

Inclined pressure reducing valve with compression ends. Replaceable cartridge and strainer. **CR** dezincification resistant alloy body. Chrome plated. Max. upstream pressure: 16 bar. Downstream pressure setting range: 1–6 bar. Max. working temperature: 40 °C.



Code			
533641	Ø 15	1	25
533651	Ø 22	1	25



**5339**

Inclined pressure reducing valve with compression ends and built-in safety relief valve. Pressure reducing valve. **CR** dezincification resistant alloy body. Replaceable cartridge and strainer. Max. upstream pressure: 1600 kPa. Downstream pressure setting range: 100–600 kPa. Max. working temperature: 40 °C. Safety relief valve. With stainless steel seat. **CR** dezincification resistant alloy body.



Code			
533944	Ø 15	1	25
533954	Ø 22	1	25



**5337**

[tech. broch. 01024](#)

Inclined pressure reducing valve with compression ends. Replaceable cartridge and strainer. **CR** dezincification resistant alloy body. Chrome plated. Max. upstream pressure: 16 bar. Downstream pressure setting range: 1–6 bar. Max. working temperature: 40 °C. With 1/4" F pressure gauge connection.



Code			
533741	Ø 15	1	20
533751	Ø 22	1	20



**5330**

Spare cartridge. For inclined pressure reducing valves 5330, 5331, 5332, 5334, 5335, 5336, 5337, 5338 and 5339 series.

Code			
533000		1	100



**5338**

[tech. broch. 01024](#)

Inclined pressure reducing valve with compression ends. Replaceable cartridge and strainer. **CR** dezincification resistant alloy body. Chrome plated. Max. upstream pressure: 16 bar. Downstream pressure setting range: 1–6 bar. Max. working temperature: 40 °C. With pressure gauge: 0–10 bar.



Code			
533841	Ø 15	1	20
533851	Ø 22	1	20

INCLINED PRESSURE REDUCING VALVES FOR HIGH TEMPERATURE



**5330..H** tech. broch. 01252

Inclined pressure reducing valve.  
For high temperature.  
Replaceable cartridge and strainer.  
Brass body. Chrome plated.  
Max. upstream pressure: 16 bar.  
Downstream pressure setting range: 1–5,5 bar.  
Max. working temperature: 80 °C.  
**Certified to EN 1567.**



Code			
533041H	1/2"	1	20
533051H	3/4"	1	20



**5331..H** tech. broch. 01252

Inclined pressure reducing valve  
for safety group.  
For high temperature.  
Replaceable cartridge and strainer.  
**CR** dezincification resistant alloy body.  
Max. upstream pressure: 16 bar.  
Downstream pressure setting range: 1–5,5 bar.  
Max. working temperature: 80 °C.  
**Certified to EN 1567.**



Code			
533159H	Ø 22 x nut 3/4" F	1	30



**5332..H** tech. broch. 01252

Inclined pressure reducing valve.  
For high temperature.  
Replaceable cartridge and strainer.  
Brass body. Chrome plated.  
Max. upstream pressure: 16 bar.  
Downstream pressure setting range: 1–5,5 bar.  
Max. working temperature: 80 °C.  
With pressure gauge: 0–10 bar.  
**Certified to EN 1567.**



Code			
533241H	1/2"	1	20
533251H	3/4"	1	20



**5332..H** tech. broch. 01252

Inclined pressure reducing valve.  
For high temperature.  
Replaceable cartridge and strainer.  
**CR** dezincification resistant alloy body.  
Chrome plated.  
Max. upstream pressure: 16 bar.  
Downstream pressure setting range: 1–5,5 bar.  
Max. working temperature: 80 °C.  
With pressure gauge: 0–10 bar.  
**Certified to EN 1567.**



Code			
533241H LTC	1/2"	1	20
533251H LTC	3/4"	1	20



**5334..H** tech. broch. 01252

Inclined pressure reducing valve.  
For high temperature.  
Replaceable cartridge and strainer.  
Brass body. Chrome plated.  
Max. upstream pressure: 16 bar.  
Downstream pressure setting range: 1–5,5 bar.  
Max. working temperature: 80 °C.  
With 1/4" F pressure gauge connection.  
**Certified to EN 1567.**



Code			
533441H	1/2"	1	20
533451H	3/4"	1	20
533461H	1"	1	25



**5334..H** tech. broch. 01252

Inclined pressure reducing valve.  
For high temperature.  
Replaceable cartridge and strainer.  
**CR** dezincification resistant alloy body.  
Chrome plated.  
Max. upstream pressure: 16 bar.  
Downstream pressure setting range: 1–5,5 bar.  
Max. working temperature: 80 °C.  
With 1/4" F pressure gauge connection.  
**Certified to EN 1567.**



Code			
533441H LTC	1/2"	1	20
533451H LTC	3/4"	1	20
533461H LTC	1"	1	20

INCLINED PRESSURE REDUCING VALVES FOR HIGH TEMPERATURE



**5336..H** tech. broch. 01252

Inclined pressure reducing valve with compression ends. For high temperature. Replaceable cartridge and strainer. **CR** dezincification resistant alloy body. Chrome plated. Max. upstream pressure: 16 bar. Downstream setting pressure range: 1–5,5 bar. Max. working temperature: 80 °C. **Certified to EN 1567.**



Code			
533641H	Ø 15	1	25
533651H	Ø 22	1	25



**5335..H**

Inclined pressure reducing valve. Replaceable cartridge and strainer. **CR** dezincification resistant alloy body **"LOW LEAD"**. Max. inlet pressure: 2000 kPa. Downstream setting pressure range: 100–600 kPa. Max. working temperature: 80 °C. With 1/4" F pressure gauge connection.



Code			
533545H AUS	1/2"	1	25
533555H AUS	3/4"	1	25
533565H AUS	1"	1	10



**5337..H** tech. broch. 01252

Inclined pressure reducing valve with compression ends. For high temperature. Replaceable cartridge and strainer. **CR** dezincification resistant alloy body. Chrome plated. Max. upstream pressure: 16 bar. Downstream setting pressure range: 1–5,5 bar. Max. working temperature: 80 °C. With 1/4" F pressure gauge connection. **Certified to EN 1567.**



Code			
533741H	Ø 15	1	20
533751H	Ø 22	1	20
533761H	Ø 28	1	20



**5335..H**

Three-way inclined pressure reducing valve. Replaceable cartridge and strainer. **CR** dezincification resistant alloy body **"LOW LEAD"**. Interchangeable outlet, with plug. Max. inlet pressure: 2000 kPa. Downstream setting pressure range: 100–600 kPa. Max. working temperature: 80 °C.



Code			
533550H AUS	3/4"	1	30



**5338..H** tech. broch. 01252

Inclined pressure reducing valve with compression ends. For high temperature. Replaceable cartridge and strainer. **CR** dezincification resistant alloy body. Chrome plated. Max. upstream pressure: 16 bar. Downstream setting pressure range: 1–5,5 bar. Max. working temperature: 80 °C. With pressure gauge: 0–10 bar. **Certified to EN 1567.**



Code			
533841H	Ø 15	1	20
533851H	Ø 22	1	20
533861H	Ø 28	1	20



**5335..H**

Two-way inclined pressure reducing valve. Replaceable cartridge and strainer. **CR** dezincification resistant alloy body **"LOW LEAD"**. Interchangeable outlet, with plug. Max. inlet pressure: 2000 kPa. Downstream setting pressure: 500 kPa. Max. working temperature: 80 °C.



Code			
533551H AUS	3/4"	1	30



**5330..H**  
Spare cartridge. For inclined pressure reducing valves 5330H, 5331H, 5332H, 5334H, 5335H, 5336H, 5337H, 5338H and 5339H series.

Code			
53300H		1	100

PRE-ADJUSTABLE PRESSURE REDUCING VALVES

5350



Pressure reducing valve with self-contained replaceable cartridge. CR dezincification resistant alloy body. With pressure regulating scale for manual pressure adjustment. Male union connections. Max. upstream pressure: 25 bar. Downstream setting pressure range: 1–6 bar. Max. working temperature: 40 °C. **Certified to EN 1567.**



With pressure gauge 0–10 bar

Code			
535041	1/2"	1	5
535051	3/4"	1	5
535061	1"	1	5
535075*	1 1/4" with 1" reduced cartridge	1	5
535071	1 1/4"	1	4
535081	1 1/2"	1	4
535091	2"	1	4

\* Without DVGW certification

With 1/4" F pressure gauge connection

Code			
535040	1/2"	1	5
535050	3/4"	1	5
535060	1"	1	5
535074*	1 1/4" with 1" reduced cartridge	1	5
535070	1 1/4"	1	4
535080	1 1/2"	1	4
535090	2"	1	4

\* Without DVGW certification

5350



Pressure reducing valve with self-contained replaceable cartridge. CR dezincification resistant alloy body. With pressure regulating scale for manual pressure adjustment. Ø 22 mm with compression ends. Max. upstream pressure: 25 bar. Downstream setting pressure range: 1–6 bar. Max. working temperature: 40 °C.



With 1/4" F pressure gauge connection

Code			
535022	Ø 22	1	10

5351

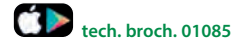

Pressure reducing valve with self-contained replaceable cartridge. Brass body. With pressure regulating scale for manual pressure adjustment. Stainless steel strainer cartridge with transparent housing. Male union connections. Max. upstream pressure: 25 bar. Downstream setting pressure range: 1–6 bar. Max. working temperature: 40 °C. Strainer mesh size Ø: 0,28 mm. **Certified to EN 1567.** **With replacement strainer and key to service strainer and cartridge.**



With stainless steel pressure gauge 0–10 bar

Code			
535141	1/2"	1	5
535151	3/4"	1	5
535161	1"	1	5

With 1/4" F pressure gauge connection

Code			
535140	1/2"	1	5
535150	3/4"	1	5
535160	1"	1	5

5350

Spare cartridge and key to service strainer and cartridge. For pressure reducing valves 5350 and 5351 series.



Code			
535004	1/2" - 3/4"	1	8
535006	1"	1	8
535017	1 1/4" (535074 - 535075)	1	8
535007	1 1/4" - 1 1/2" - 2"	1	–
R52484*	key to service strainer and cartridge	1	–

\* Only for 1/2", 3/4", 1" reducing valves

PRE-ADJUSTABLE PRESSURE REDUCING VALVES FOR HIGH TEMPERATURE



5350..H

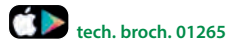

Pressure reducing valve with self-contained replaceable cartridge. For high temperature. **CR** dezincification resistant alloy body "LOW LEAD". With pressure regulating scale for manual pressure adjustment. Male union connections.

Max. inlet pressure: 25 bar (static - EN 1567).  
Max. inlet pressure: 16 bar (working - EN 1567).  
Downstream setting pressure range: 1-6 bar.  
Max. working temperature: 80 °C.  
**Certified to EN 1567.**



With pressure gauge 0-10 bar

Code			
535041H	1/2"	1	5
535051H	3/4"	1	5
535061H	1"	1	5
535071H	1 1/4"	1	4
535081H	1 1/2"	1	4
535091H	2"	1	4

With 1/4" F pressure gauge connection

Code			
535040H	1/2"	1	5
535050H	3/4"	1	5
535060H	1"	1	5
535070H	1 1/4"	1	4
535080H	1 1/2"	1	4
535090H	2"	1	4



5350..H



Pressure reducing valve with self-contained replaceable cartridge. For high temperature. **CR** dezincification resistant alloy body "LOW LEAD". With pressure regulating scale for manual pressure adjustment.

Compression ends connections.  
Max. inlet pressure: 25 bar (static - EN 1567).  
Max. inlet pressure: 16 bar (working - EN 1567).  
Downstream setting pressure range: 1-6 bar.  
Max. working temperature: 80 °C.  
**Certified to EN 1567.**



With 1/4" F pressure gauge connection

Code			
535015H	Ø 15	1	5
535022H	Ø 22	1	5
535028H	Ø 28	1	5



5350..H



Pressure reducing valve with self-contained replaceable cartridge. For high temperature. **CR** dezincification resistant alloy body "LOW LEAD". With pressure regulating scale for manual pressure adjustment. Male union connections.

Max. upstream pressure: 2000 kPa.  
Downstream setting pressure range: 100-600 kPa.  
Max. working temperature: 80 °C.



With 1/4" F pressure gauge connection

Code			
535040H AUS	1/2"	1	5
535050H AUS	3/4"	1	5
535060H AUS	1"	1	5
535070H AUS	1 1/4"	1	4
535080H AUS	1 1/2"	1	4
535090H AUS	2"	1	4

5350..H

Spare cartridge for pressure reducing valves 5350H series.



Code			
535006H	1/2" - 3/4" - 1"	1	8
535009H	1 1/4" - 1 1/2" - 2"	1	-

PRESSURE REDUCING VALVE

539



Pressure reducing valve. **CR** dezincification resistant alloy body. Supplied with two female - male fittings. Max. upstream pressure: 25 bar. Downstream setting pressure range: 1-5,5 bar. Factory set: 3 bar. Max. working temperature: 80 °C. **Certified to EN 1567.**



With 1/4" F double pressure gauge connection

Code			
539250	3/4"	1	20

PRESSURE REDUCING VALVES

5360



tech. broch. 01026



Pressure reducing valve with replaceable cartridge.  
 CR dezincification resistant alloy body.  
 Male union connections.  
 Max. upstream pressure: 25 bar.  
 Downstream setting pressure range: 0,5–6 bar.  
 Max. working temperature: 80 °C.  
**Certified to EN 1567.**



With pressure gauge 0–10 bar

Code			
536041	1/2"	1	5
536051	3/4"	1	5
536061	1"	1	5
536071	1 1/4"	1	4
536081	1 1/2"	1	4

With 1/4" F pressure gauge connection

Code			
536040	1/2"	1	5
536050	3/4"	1	5
536060	1"	1	5
536070	1 1/4"	1	4
536080	1 1/2"	1	4

5362



tech. broch. 01026



Pressure reducing valve with replaceable cartridge.  
 CR dezincification resistant alloy body.  
 Female connections.  
 Max. upstream pressure: 25 bar.  
 Downstream setting pressure range: 0,5–6 bar.  
 Max. working temperature: 80 °C.



With pressure gauge 0–10 bar

Code			
536241	1/2"	1	5
536251	3/4"	1	5
536261	1"	1	5

With 1/4" F pressure gauge connection

Code			
536240	1/2"	1	5
536250	3/4"	1	5
536260	1"	1	5

537

Soldering union connections.



Code			
537015	3/4" x Ø 15	1	–
537022	1" x Ø 22	1	–
537028	1 1/4" x Ø 28	1	–
537035	1 1/2" x Ø 35	1	–

5365

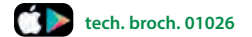

tech. broch. 01026

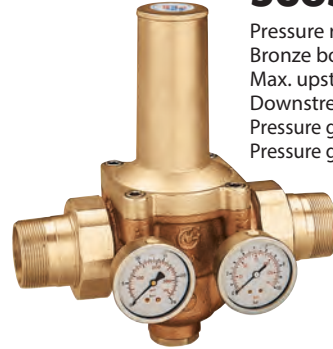

Pressure reducing valve with replaceable cartridge.  
 Bronze body. Male union connections.  
 Max. upstream pressure: 25 bar.  
 Downstream setting pressure range: 0,5–6 bar.  
 Pressure gauge upstream: 0–25 bar.  
 Pressure gauge downstream: 0–10 bar.  
 Max. working temperature: 80 °C.  
**Certified to EN 1567.**



With double pressure gauge in glycerine bath

Code			
536581	1 1/2"	1	–
536591	2"	1	–

With 1/4" F double pressure gauge connection

Code			
536580	1 1/2"	1	–
536590	2"	1	–

5366



tech. broch. 01026



Pressure reducing valve with replaceable cartridge.  
 Bronze body. Flanged connections, PN 16.  
 To be coupled with flat counterflanges EN 1092-1.  
 Max. upstream pressure: 16 bar.  
 Downstream setting pressure range: 0,5–6 bar.  
**With double pressure gauge** in glycerine bath.  
 Pressure gauge upstream: 0–25 bar.  
 Pressure gauge downstream: 0–10 bar.  
 Max. working temperature: 80 °C.



Code			
536660	DN 65	1	–

5360

Spare cartridge  
 for pressure reducing valves  
 5360, 5362, 5365 and 5366 series.



Code			
536004	1/2"	1	–
536005	3/4" - 1"	1	–
536027	1 1/4" - 1 1/2" (5360)	1	–
536008	1 1/2" (5365) - 2" - DN 65	1	–

**PRESSURE REDUCING VALVES FOR FIRST STAGE CONTROL**



**5360**



Pressure reducing valve for first stage control, with replaceable cartridge. Piston operation. **CR** dezincification resistant alloy body **"LOW LEAD"**. Male union connections. Max. upstream pressure: 2500 kPa. Downstream setting pressure range: 600–1000 kPa. Pressure gauge: 0–2500 kPa. Max. working temperature: 80 °C.



Code				
536043 AUS	1/2"		1	5
536053 AUS	3/4"		1	5
536063 AUS	1"		1	5
536073 AUS	1 1/4"		1	4
536083 AUS	1 1/2"		1	4

**Application diagram of pressure reducing valve code 5360.3 AUS**

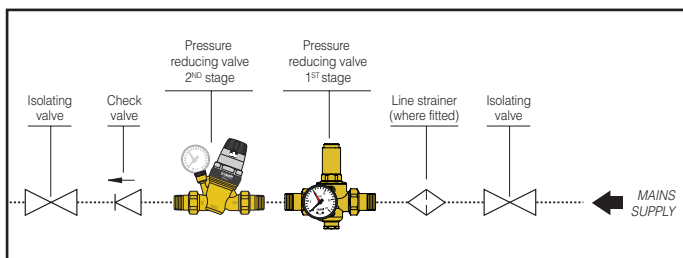

**PRESSURE REDUCING VALVES FOR HIGH-RISE BUILDINGS**



**5335..HS**



Inclined pressure reducing valve. Replaceable cartridge and strainer. Piston operation. **CR** dezincification resistant alloy body **"LOW LEAD"**. Max. inlet pressure: 2000 kPa. Downstream setting pressure range: 100–600 kPa. Max. working temperature: 80 °C. With 1/4" F pressure gauge connection. For applications with higher pressure reduction ratio in hot and cold water distribution system.



Code				
533545HS AUS	1/2"		1	25
533555HS AUS	3/4"		1	25

**PRESSURE REDUCING AND STABILISING VALVES**

**576**



Pressure reducing valve. Cast iron body, PN 16. Flanged connections PN 16. To be coupled with flat counterflanges EN 1092-1. Max. upstream pressure: 16 bar. Downstream setting pressure range: 2–14 bar. Max. working temperature: 60 °C. Supplied with double pressure gauge. For combination with Y-strainer 579 series (see page 230). **Available on request PN 25 and PN 40.**



Code				
576062	DN 65		1	–
576082	DN 80		1	–
576102	DN 100		1	–
576122	DN 125		1	–
576152	DN 150		1	–

**578**

Pilot operated pressure reducing valves. Cast iron body, PN 16. Flanged connections. To be coupled with flat counterflanges EN 1092-1: DN 65–DN 150, PN 16; DN 200–DN 300, PN 10. Max. upstream pressure: 16 bar. Downstream setting pressure range: 2–14 bar. Max. working temperature: 65 °C. Supplied with double pressure gauge.



Code				
578062	DN 65		1	–
578082	DN 80		1	–
578102	DN 100		1	–
578122	DN 125		1	–
578152	DN 150		1	–
578202	DN 200		1	–
578252	DN 250		1	–
578302	DN 300		1	–

COMBINED GROUP FOR PRESSURE CONTROL IN DOMESTIC WATER SYSTEMS

539..H

tech. broch. 01389



Combined group for pressure control in domestic water systems with self-contained replaceable cartridge. For high temperature. **CR** dezincification resistant alloy body "LOW LEAD". Shut-off valve with extended lever. EA type check valve. Max. upstream pressure: 16 bar.

Downstream setting pressure range: 1-5,5 bar. Max. working temperature: 80 °C. With G 1/4" upstream and downstream pressure test ports.

Pressure reducing valve certified to EN 1567. Check valve certified to EN 13959. PATENT PENDING



Characteristic components

1. Compact, self-contained body
2. Shut-off valve
3. Pressure reducing valve with filter (EN 1567)
4. Check valve, EA type (EN 13959)
5. Upstream test port
6. Downstream test port
7. Captive nut

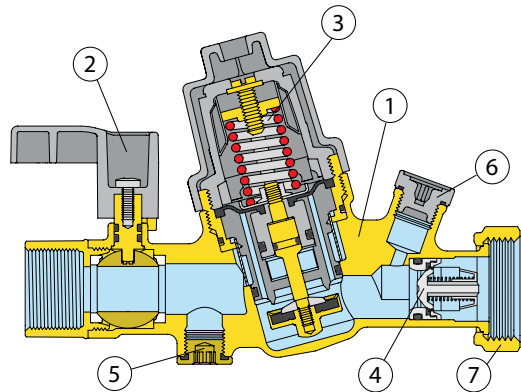

Code					
539050H	Rp 3/4" x G 1"	with captive nut	1	5	

Function

The combined group for pressure control in domestic water systems combines three different devices in a single component: a ball shut-off valve, a pressure reducing valve with filter and an EA type check valve. Installed on the pipe supplying hot or cold water to the users, it reduces the pressure of the water coming from the mains network, prevents the backflow of water into the mains system and allows users to be shut off during testing and maintenance procedures. The cartridge containing the diaphragm, strainer, seat, obturator and compensating piston is pre-assembled as a self-contained unit with a cover. It is easy to remove, simplifying inspection and maintenance procedures. The internal strainer, cleanable, is part of the cartridge and cannot be removed.

Removable self-contained cartridge

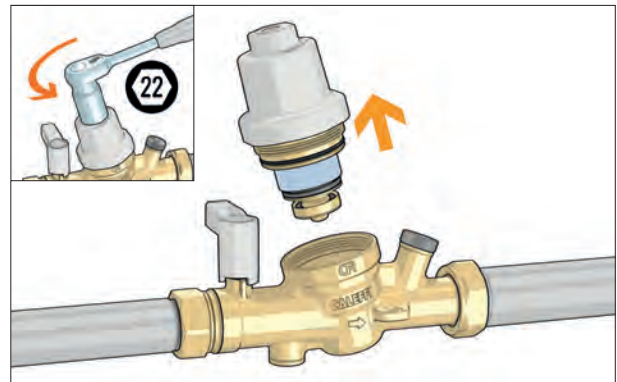

ACCESSORIES FOR COMBINED GROUP FOR PRESSURE CONTROL 539H

557

tech. broch. 01389

Pressure gauge. Ø 40 mm. Accuracy class: UNI 2,5.



Code	bar				
557010	0-10	1/4"	central back conn.	1	-
F0002665	0-10	1/4"	bottom conn.	1	-

tech. broch. 01389

Insulation for 539H series combined group.



Code					
CBN539050				1	8

539..H

tech. broch. 01389

Spare cartridge for combined group for pressure control



Code					
539005H	3/4"			1	8

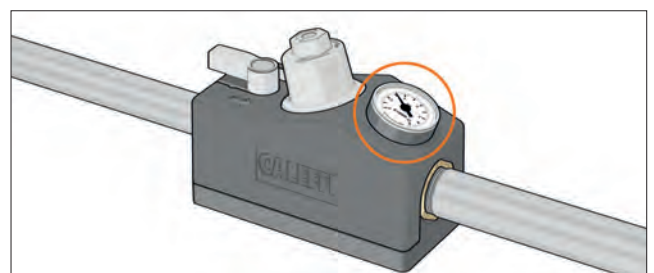



**COMBINED GROUP FOR PRESSURE AND TEMPERATURE CONTROL IN DOMESTIC WATER SYSTEMS**



**539H**

Combined group for pressure and temperature control in domestic water systems.

**CR dezincification resistant alloy body "LOW LEAD".**

Consisting of:

- 539H series combined unit, cold water circuit
- 539H series combined unit, hot water circuit
- adjustable thermostatic mixing valve with advanced thermal performance and anti-scald function

**Certified to EN 1111 and EN 1287.**

- connection tee complete with check valve
- pressure gauges (optional).

**Mixing valve performance**

Max. working pressure: 10 bar.  
 Inlet Tmax: 90 °C.  
 Temperature adjustment range:  
 35–65°C.  
 Kv: 1,7 m³/h.

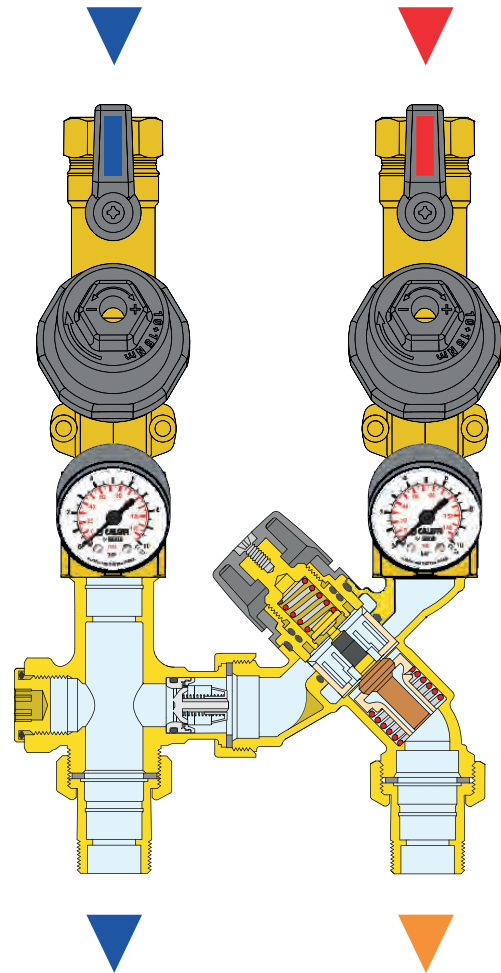

Code

**539500H** Rp 3/4" x G 3/4" with union

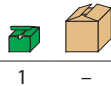

1 -

**Function**

It is essential to install various components capable of fulfilling all the required functions at the inlet of individual housing units, hotel rooms or hospital rooms, where it is necessary to control both the pressure and the temperature. The function of the combined unit is to keep the pressure and temperature of the mixed water supplied to the user constant at the set value, in spite of variations in the hot and cold water supply conditions at the inlet, thereby making pipe connections easier.

**Application diagram of combined group**

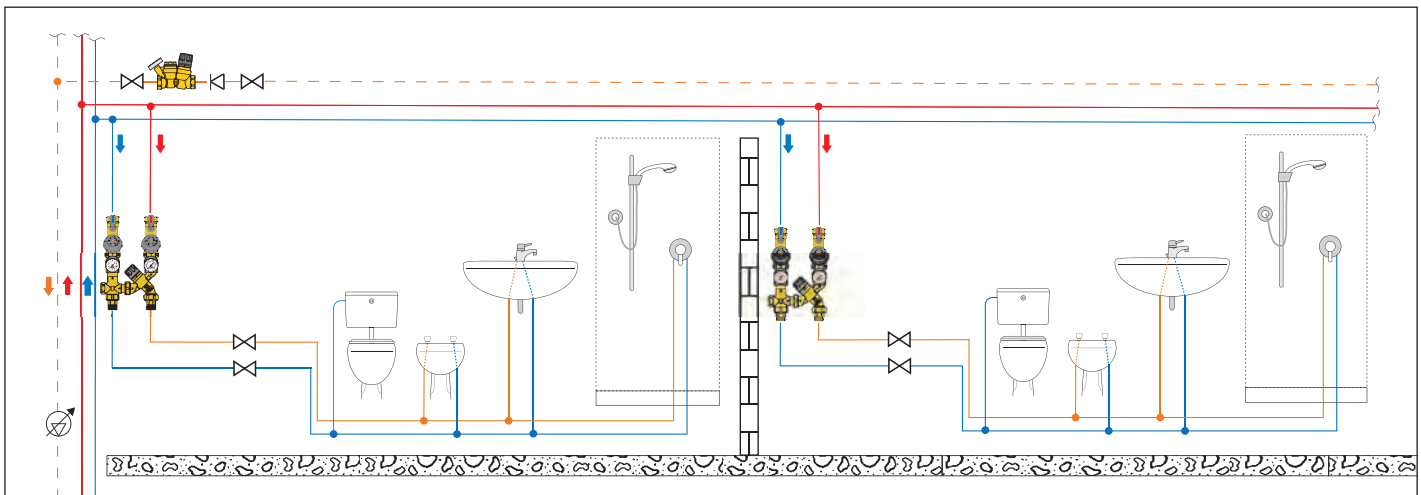



# THERMOSTATIC MIXING VALVES

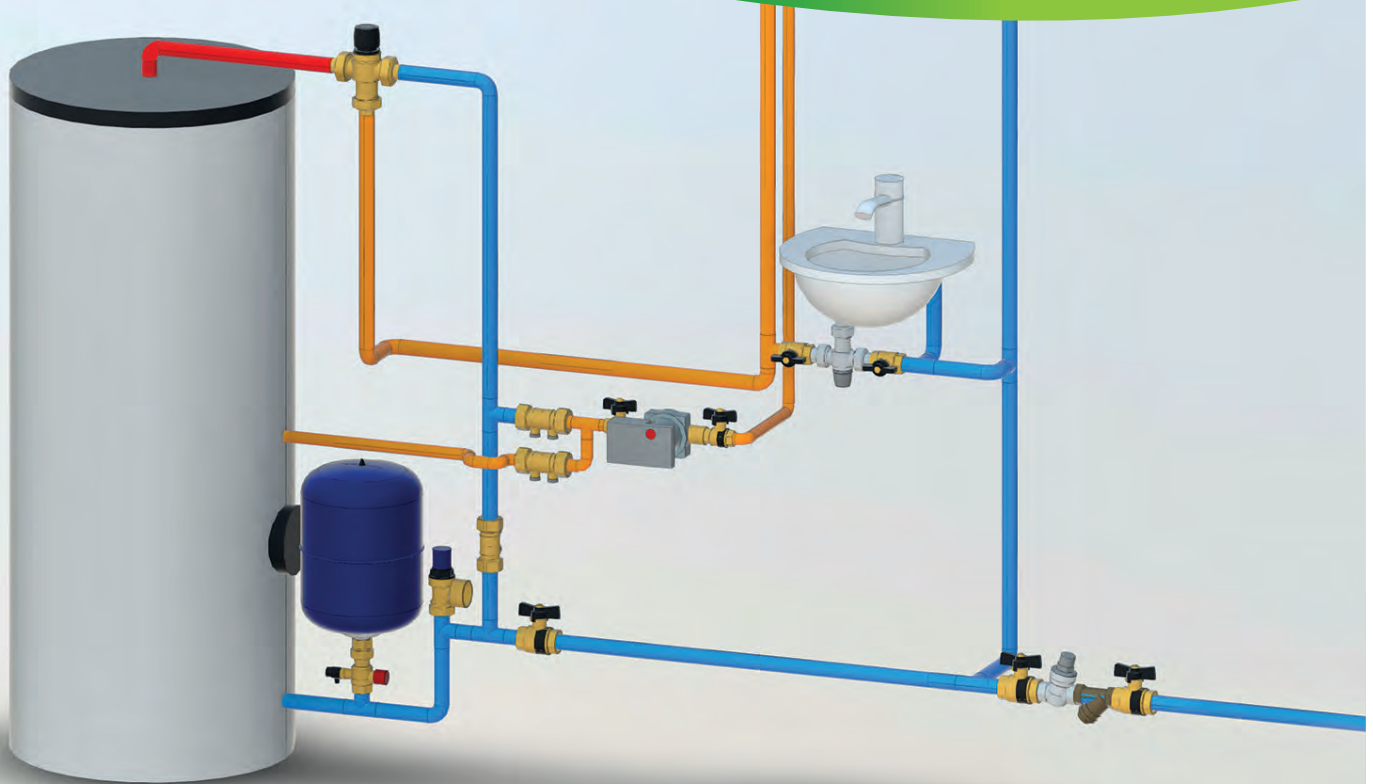

*Diagrams made with BIM families: [bim.caleffi.com](http://bim.caleffi.com)*

## **Thermostatic mixing valves**

**Hybrid electronic mixing valves, LEGIOMIX® 2.0**

**Electronic mixing valves with thermal disinfection and interface, LEGIOMIX®**

**Anti-scald device**

**Unit for temperature control and thermal disinfection, LEGIOFLOW®**

**Timer for valves operation**

**Multi-function thermostatic regulator**



**Domestic Water Sizer**



**DOMESTIC WATER SYSTEM SIZER ALSO FOR SMARTPHONE**

Available on [www.caleffi.com](http://www.caleffi.com) and app for smartphone.

Download the version for your iOS and Android® mobile phone.

THERMOSTATIC MIXING VALVES FOR SMALL APPLICATIONS



**520** tech. broch. 01064

Adjustable thermostatic mixing valve. Brass body. Chrome plated. Max. working pressure: 10 bar. Max. inlet temperature: 90 °C.



Code	Temperature adjustment	Kv (m³/h)		
520430	1/2" 30–48 °C	1,30	1	50
520440	1/2" 40–60 °C	1,30	1	50
520530	3/4" 30–48 °C	1,80	1	50
520540	3/4" 40–60 °C	1,80	1	50
520630	1" 30–48 °C	2,75	1	10
520640	1" 40–60 °C	2,75	1	10



**521** tech. broch. 01050

Adjustable **anti-scale** thermostatic mixing valve with check valves. **CR** dezincification resistant alloy body. **"LOW LEAD"**. Chrome plated. Max. working pressure: 14 bar. Max. inlet temperature: 85 °C.



Code	Temperature adjustment	Kv (m³/h)		
521503	3/4" 30–65 °C	2,6	1	10



**522** tech. broch. 01064

Adjustable thermostatic mixing valve. For hot water storage heaters. Brass body. Chrome plated. Max. working pressure: 10 bar. Max. inlet temperature: 90 °C.

Code	Temperature adjustment	Kv (m³/h)		
522430	1/2" 30–48 °C	1,30	1	15
522440	1/2" 40–60 °C	1,30	1	15



**521** tech. broch. 01050

Adjustable **anti-scale** thermostatic mixing valve with check valves, strainers at the inlets and compression ends. **CR** dezincification resistant alloy body. **"LOW LEAD"**. Chrome plated. Max. working pressure: 14 bar. Max. inlet temperature: 85 °C.



Code	Temperature adjustment	Kv (m³/h)		
521115	Ø 15 30–65 °C	2,6	1	10
521122	Ø 22 30–65 °C	2,6	1	10



**521** tech. broch. 01050

Adjustable **anti-scale** thermostatic mixing valve. **CR** dezincification resistant alloy body. **"LOW LEAD"**. Chrome plated. Max. working pressure: 14 bar. Max. inlet temperature: 85 °C.



Code	Temperature adjustment	Kv (m³/h)		
521400	1/2" 30–65 °C	2,6	1	10
521500	3/4" 30–65 °C	2,6	1	10

Application diagram of thermostatic mixing valve 521 series

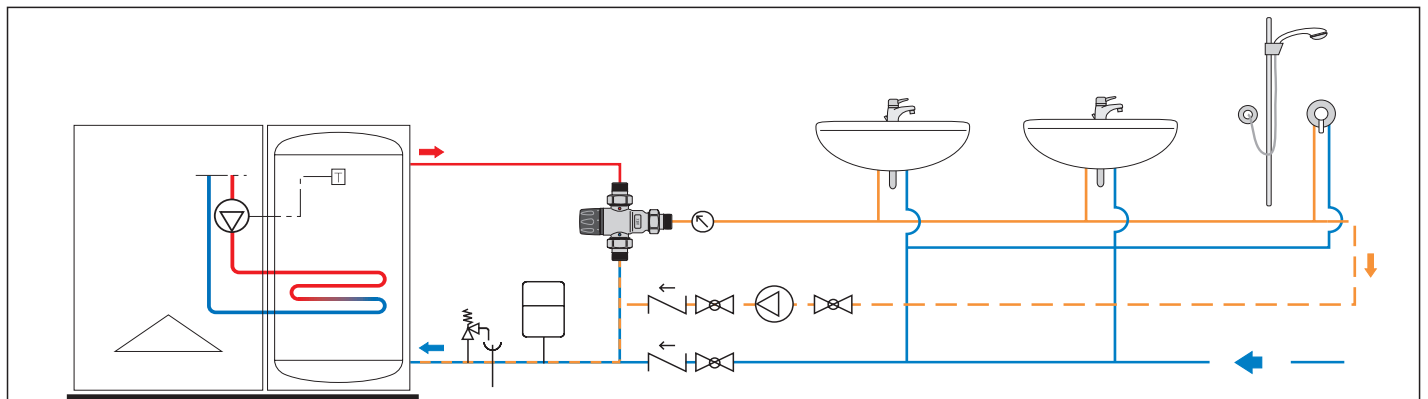

TEMPERING VALVE FOR INSTALLATION AT THE POINT OF DISTRIBUTION



5219

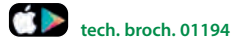

Tempering valve adjustable with knob. For temperature control at the point of distribution. **With thermal shut-off function.**

CR dezincification resistant alloy body. "LOW LEAD". Chrome plated. Max. working pressure: 10 bar. Max. inlet temperature: 90 °C. PATENT.



5218

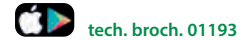

Tempering valve adjustable with knob, **with check valves and strainers.**

Specific to control the temperature at the point of distribution. **With thermal shut-off function.** CR dezincification resistant alloy body. "LOW LEAD". Chrome plated. Max. working pressure: 10 bar. Max. inlet temperature: 90 °C. **Certified to EN 15092.** PATENT.



Code	Temperature adjustment	Kv (m³/h)		
521934	1/2"	35-65 °C	1,5	1 10
521935	3/4"	35-65 °C	1,7	1 10
521936	1"	35-65 °C	3,0	1 5

Code	Temperature adjustment	Kv (m³/h)		
521814	1/2"	45-65 °C	1,5	1 10
521815	3/4"	45-65 °C	1,7	1 10
521816	1"	45-65 °C	3,0	1 5

With check valves and strainers

Code	Temperature adjustment	Kv (m³/h)		
521914	1/2"	35-65 °C	1,5	1 10
521915	3/4"	35-65 °C	1,7	1 10
521916	1"	35-65 °C	3,0	1 5

European certification

European standard EN 15092 "Inline hot water supply tempering valves. - Tests and requirements" specifies the performance characteristics for tempering valves installed at the point of distribution in domestic water systems made in accordance with the recent European standards EN 806-1/2/3/4/5. The 5218 series tempering valves are certified as compliant with these standards by the certification Scheme NSF DTC (UK).

Application diagram of thermostatic mixing valve at the point of distribution

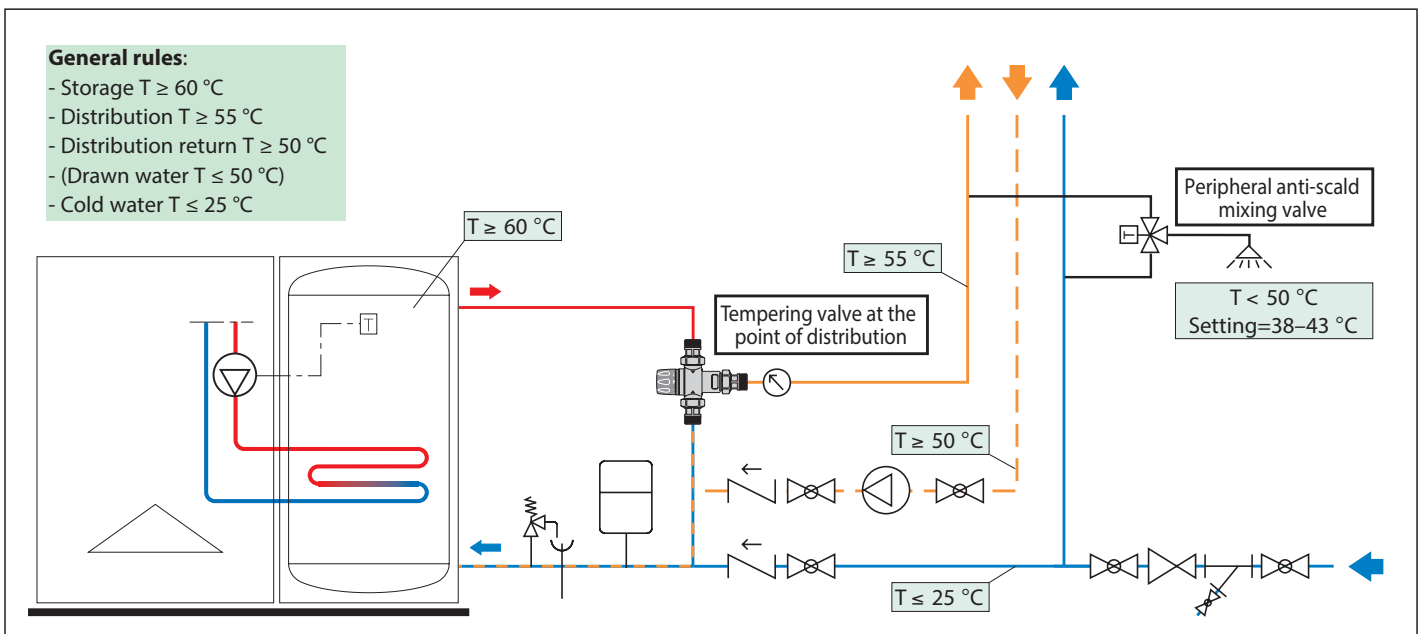



ANTI-SCALD THERMOSTATIC MIXING VALVES FOR INSTALLATION AT THE POINT OF USE

**5213**  tech. broch. 01092



Adjustable thermostatic mixing valve with check valves and strainers at the inlets. Enhanced thermal performance device with anti-scald safety function.  
**CR** dezincification resistant alloy body. Chrome plated.  
 Max. working pressure: 10 bar.  
 Max. inlet temperature: 85 °C.  
**Certified to NHS D08, BS 7942, EN 1111 and EN 1287.**



Code	Temperature adjustment	Kv (m³/h)		
521304	1/2"	30-50 °C	1	10
521303	3/4"	30-50 °C	1	10
521306*	1"	30-50 °C	1	10

\* Certified WRAS only

Adjustment temperature of mixing valve 5213 series

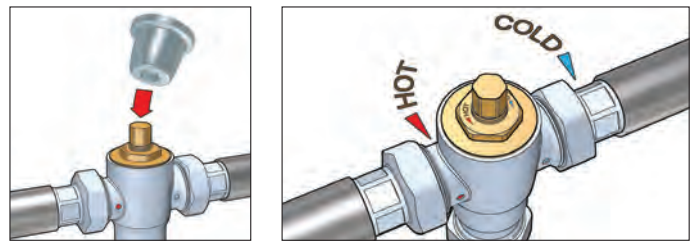

Application diagram of mixing valves 5213 or 5217 series

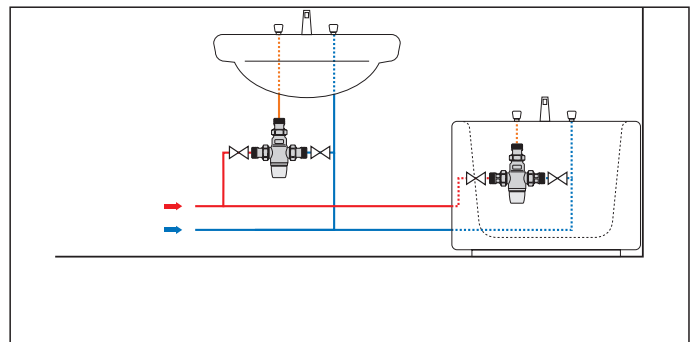



**5213**  tech. broch. 01092



Adjustable thermostatic mixing valve with check valves, strainers and compression ends. Enhanced thermal performance device with anti-scald safety function.  
**CR** dezincification resistant alloy body. Chrome plated.  
 Max. working pressure: 10 bar.  
 Max. inlet temperature: 85 °C.  
**Certified to NHS D08, BS 7942, EN 1111 and EN 1287.**



Code	Temperature adjustment	Kv (m³/h)		
521315	Ø 15	30-50 °C	1	10
521322	Ø 22	30-50 °C	1	10

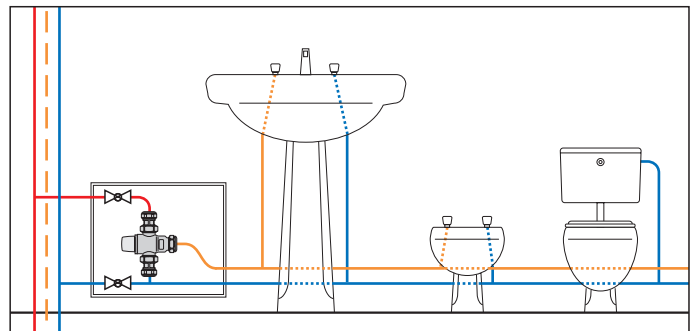

Application diagram of mixing valves 5213 or 5217 series with distribution group

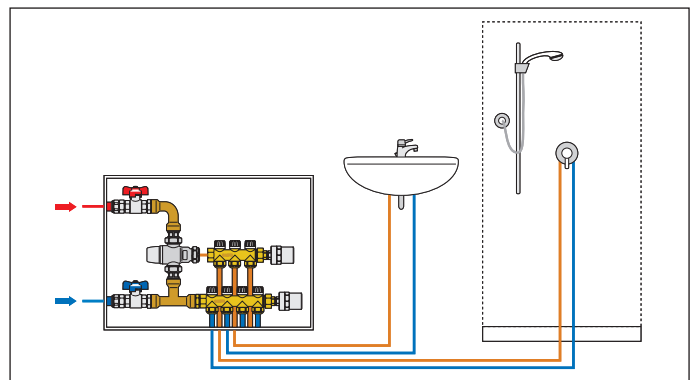



**5217**  tech. broch. 01145





Thermostatic mixing valve, adjustable with knob, with check valves and strainers at the inlets. Enhanced thermal performance device with anti-scald safety function.  
 Brass body. Chrome plated.  
 Max. working pressure: 10 bar.  
 Max. inlet temperature: 85 °C.  
**Certified to NF 079 Doc. 8.**



Code	Temperature adjustment	Kv (m³/h)		
521714	1/2"	30-50 °C	1	10
521713	3/4"	30-50 °C	1	10



Pre-formed shell insulation for 1/2" and 3/4" thermostatic mixing valves 5213, 5217, 5218 and 5219 series.

Code		
<b>CBN521814</b>	1	25
<b>CBN521815</b>	1	25

ADJUSTABLE THERMOSTATIC MIXING VALVE FOR UNDER SINK INSTALLATION



5212

Adjustable thermostatic mixing valve for under sink installation. With check valves and strainers at the inlets. Enhanced thermal performance device with anti-scald safety function. Complete with mounting brackets and adjustment key. **CR** dezincification resistant alloy body. **"LOW LEAD"**.  
 Max. working pressure: 10 bar.  
 Max. inlet temperature: 90 °C.  
**Certified to ASSE 1070.**



Code	Temperature adjustment	Kv (m³/h)		
521201	3/8"	35-50 °C	0,45	1 -

Application diagram of mixing valve code 521201

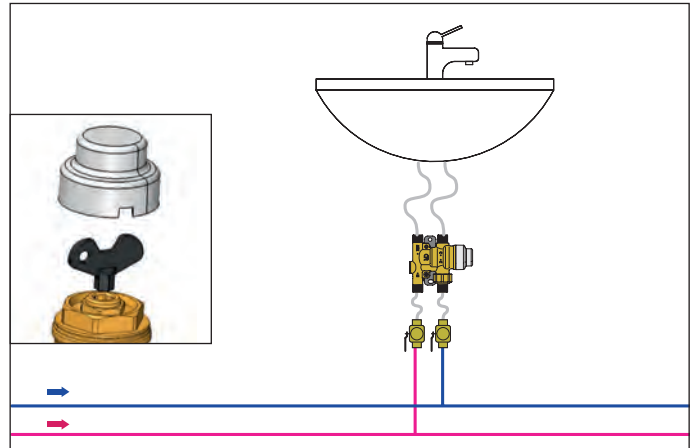

ANTI-SCALD TEMPERING AND THERMOSTATIC MIXING VALVES



5213

Adjustable anti-scald tempering valve with check valves and strainers at the inlets. **CR** dezincification resistant alloy body. **"LOW LEAD"**.  
 Chrome plated.  
 Male union connections.  
**With insulation.**  
 Max. working pressure: 1400 kPa.  
 Max. inlet temperature: 85 °C.  
**Certified to AS 4032.2.**



Code	Temperature adjustment	Kv (m³/h)		
521312 AUS	DN 15	30-50 °C	1,5	1 10
521319 AUS	DN 20	30-50 °C	1,7	1 10
521325 AUS	DN 25	20-50 °C	4,2 without insulation	1 10



5213

Adjustable thermostatic mixing valve with isolating valves, check valves and strainers at the inlets. Enhanced thermal performance device with anti-scald safety function. **CR** dezincification resistant alloy body. **"LOW LEAD"**.  
 Chrome plated.  
 Max. working pressure: 1400 kPa.  
 Max. inlet temperature: 85 °C.  
**Certified to AS 4032.1.**



Code	Temperature adjustment	Kv (m³/h)		
521312TMX AUS	1/2"	30-50 °C	1,3	1 10
521319TMX AUS	3/4"	30-50 °C	1,4	1 10

## COMBINED GROUP FOR PRESSURE AND TEMPERATURE CONTROL IN DOMESTIC WATER SYSTEMS



### 5200



tech. broch. 01266

Adjustable thermostatic mixing valve with knob, complete with check valves and strainers at the inlets.

**Enhanced performance with thermal shut-off function.**

CR dezincification resistant alloy body "LOW LEAD".

Male union connections.

Max. working pressure: 10 bar.

Max. inlet temperature: 90 °C.

**Certified to EN 1111 and EN 1287.**



kiwa

1.59/20511

Code	Body DN	Conn.	Temperature adjustment	Kv (m <sup>3</sup> /h)		
520040	15	1/2"	35–65 °C	1,5	1	10
520050	20	3/4"	35–65 °C	1,7	1	10
520060	25	1"	35–65 °C	3,0	1	5



### 520



tech. broch. 01389

Connection tee for 5200 series thermostatic mixing valve complete with check valve.

CR dezincification resistant alloy body "LOW LEAD".

Connections: inlet G 1"

side G 1" with nut

outlet G 3/4" with union

Max. working pressure: 10 bar.

Max. inlet temperature: 90 °C.

Code	Body DN	Conn.		
520004	20	G 1" x G 1" with nut x G 3/4" with union	1	-



### 539H

Combined group for pressure and temperature control in domestic water systems.

CR dezincification resistant alloy body "LOW LEAD".

Consisting of:

- 539H series combined unit, cold water circuit
- 539H series combined unit, hot water circuit

- adjustable thermostatic mixing valve with advanced thermal performance and anti-scald function

**Certified to EN 1111 and EN 1287.**

- connection tee complete with check valve
- pressure gauges (optional).

**Mixing valve performance**

Max. working pressure: 10 bar.

Inlet Tmax: 90 °C.

Temperature adjustment range:

35–65°C.

Kv: 1,7 m<sup>3</sup>/h.



Code		
539500H Rp 3/4" x G 3/4" with union	1	-

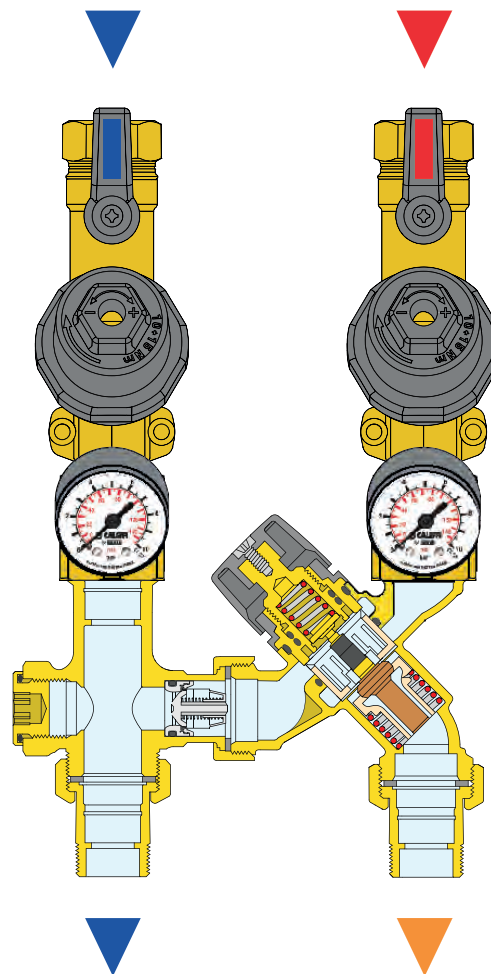

#### Function

It is essential to install various components capable of fulfilling all the required functions at the inlet of individual housing units, hotel rooms or hospital rooms, where it is necessary to control both the pressure and the temperature. The function of the combined unit is to keep the pressure and temperature of the mixed water supplied to the user constant at the set value, in spite of variations in the hot and cold water supply conditions at the inlet, thereby making pipe connections easier.

#### Application diagram of combined group

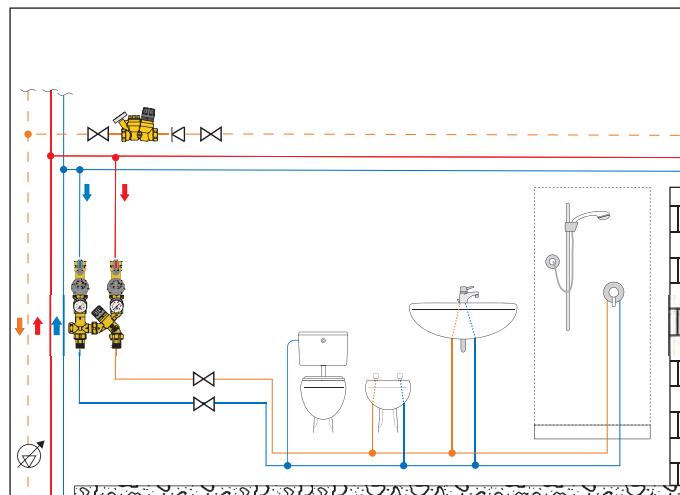



CONTROL UNIT FOR DOMESTIC HOT WATER TEMPERATURE



5201



Control unit for domestic hot water temperature at the point of distribution.

Consisting of:

- thermostatic mixing valve with thermal shut-off function,
- tee for cold water connection complete with check valves.

Max. working pressure: 10 bar.

Max. inlet temperature: 90 °C.

**Mixing valve certified to EN 1111 and EN 1287 standards.**



Code	Body DN	Conn.	Temperature adjustment	Kv (m³/h)		
520150	20	3/4"	35–65 °C	1,7	1	–
520160	25	1"	35–65 °C	3,0	1	–
520162*	25	1"	35–65 °C	3,0	1	–

\* With off-centre fittings



520

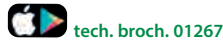

Accessory kit for recirculation connection complete with check valves.

Max. working pressure: 10 bar.

Max. inlet temperature: 90 °C.

Code	Body DN	Conn.		
520005	20	3/4"	1	–



Pre-formed shell insulation for control unit for domestic hot water temperature at the point of distribution 5201 series.

Code		
CBN520150	1	25
CBN520160	1	25



6480

Pair of off-centre fittings for connecting temperature control unit to any storage with outlet centre distance between 100 and 120 mm.

Code	Conn.		
648005	3/4"	1	–
648006	1"	1	–

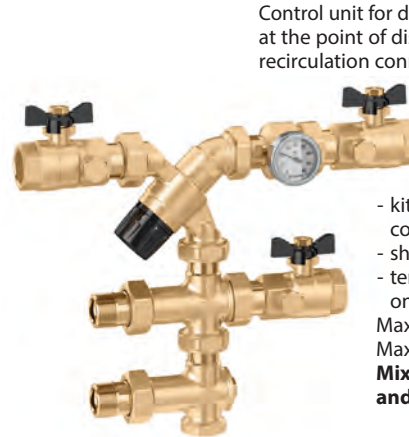

5201



Control unit for domestic hot water temperature at the point of distribution, complete with recirculation connection. Consisting of:

- thermostatic mixing valve with thermal shut-off function,
- tee for cold water connection complete with check valves,
- kit for recirculation connection complete with check valves,
- shut-off valves,
- temperature gauge with pocket on the mixed water outlet.

Max. working pressure: 10 bar.

Max. inlet temperature: 90 °C.

**Mixing valve certified to EN 1111 and EN 1287 standards.**

Code	Body DN	Conn.	Temperature adjustment	Kv (m³/h)		
520155	20	3/4"	35–65 °C	1,7	1	–

Specifications

The control unit for domestic hot water temperature is equipped with a high performance thermostatic mixing valve with a thermal shut-off function. This makes it possible to maintain a flow temperature at the distribution point that is perfectly stable at the required value.

The domestic hot water temperature control unit allows easy **connection between pipes serving the domestic hot water and storage system**, making it possible to minimise space requirements for installation. The unit is supplied with the **check valves that allow correct operation of the mixing valve in the presence of recirculation**. The group's modularity makes it extremely flexible, since it allows orientation of the various pipe connections in accordance with installation requirements. The shut-off valves with connection ports and temperature gauge on the mixed water outlet facilitate commissioning, checking and maintenance operations.

Interchangeable cold/recirculation connections

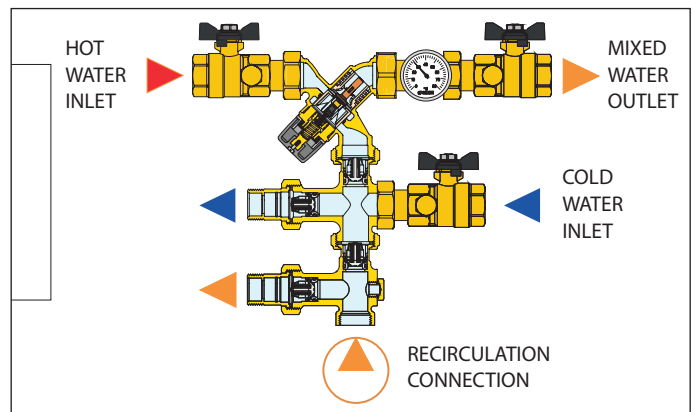

Without recirculation circuit

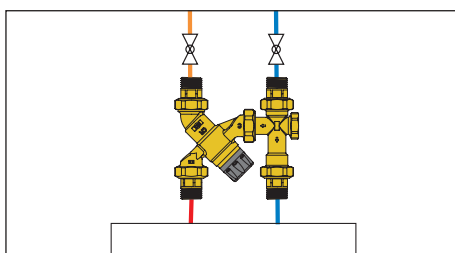

Storage without recirculation connection

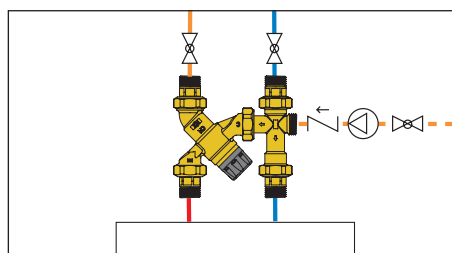

Storage with recirculation connection

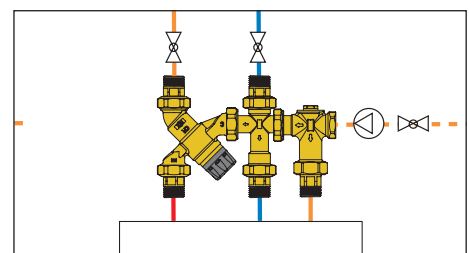

THERMOSTATIC MIXING VALVES FOR MEDIUM-LARGE APPLICATIONS

5231



Adjustable thermostatic mixing valve, for centralised systems.  
 CR dezincification resistant alloy body.  
 Antiscale inner regulator in technopolymer.  
 Max. working pressure: 14 bar.  
 Max. inlet temperature: 90 °C.



5230



Adjustable thermostatic mixing valve, with replaceable cartridge, for centralised systems.  
 Brass body.  
 Max. working pressure: 14 bar.  
 Max. inlet temperature: 85 °C.



Code	Temperature adjustment	Kv (m³/h)		
523140	1/2"	35-65 °C 4,3	1	5
523150	3/4"	35-65 °C 4,5	1	5
523160	1"	35-65 °C 5,5	1	-
523170	1 1/4"	35-65 °C 7,6	1	-
523180	1 1/2"	35-65 °C 11,0	1	-
523190	2"	35-65 °C 13,3	1	-

Code	Temperature adjustment	Kv (m³/h)		
523040	1/2"	30-65 °C 4,0	1	-
523050	3/4"	30-65 °C 4,5	1	-
523060	1"	30-65 °C 6,9	1	-
523070	1 1/4"	30-65 °C 9,1	1	-
523080	1 1/2"	36-60 °C 14,5	1	-
523090	2"	36-60 °C 19,0	1	-

With check valves

Code	Temperature adjustment	Kv (m³/h)		
523163	1"	35-65 °C 5,5	1	-
523173	1 1/4"	35-65 °C 7,6	1	-

With check valves

Code	Temperature adjustment	Kv (m³/h)		
523043	1/2"	30-65 °C 4,0	1	-
523053	3/4"	30-65 °C 4,5	1	-
523063	1"	30-65 °C 6,9	1	-
523073	1 1/4"	30-65 °C 9,1	1	-

With check valves and compression ends

Code	Temperature adjustment	Kv (m³/h)		
523162	Ø 28	35-65 °C 7,6	1	-

With check valves and compression ends

Code	Temperature adjustment	Kv (m³/h)		
523052	Ø 22	30-65 °C 4,5	1	-
523062	Ø 28	30-65 °C 6,9	1	-

Application diagram of mixing valve 5231 series

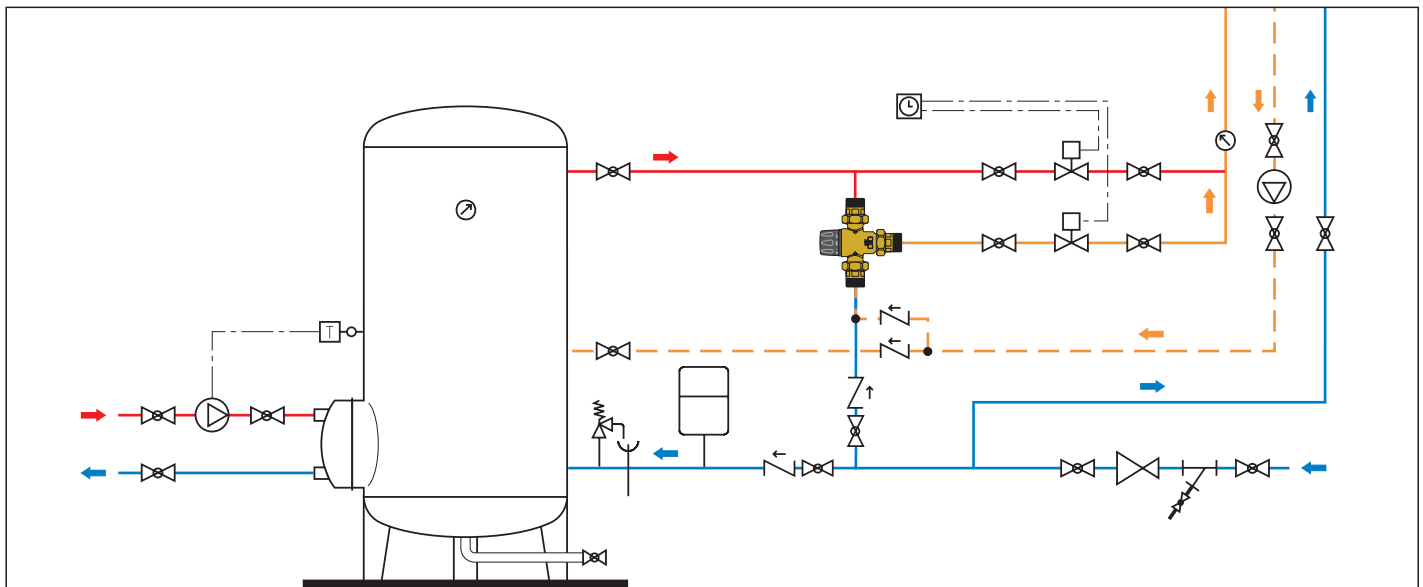

THERMOSTATIC MIXING VALVE FOR MEDIUM-LARGE APPLICATIONS



524

Adjustable thermostatic mixing valve for centralised systems. With recirculation connection. Male threaded connections. Brass body. Max. working pressure: 10 bar. Max. inlet temperature: 90 °C.





524

Adjustable thermostatic mixing valve. Bronze body, PN 10. Flanged connections. Equipped with flat counterflanges EN 1092-1, PN 10. Recirculation pipe connections. Factory setting: 48 °C. Max. working pressure: 10 bar. Max. inlet temperature: 90 °C.



tech. broch. 01063

Code	Body DN	Temperature adjustment	Kv (m³/h)		
524400*	15 1 1/8"	30-65 °C	1,4	1	-
524500	20 1 1/4"	30-65 °C	2,5	1	-
524600	25 1 1/2"	30-65 °C	4,0	1	-
524700	32 2"	30-65 °C	7,7	1	-
524800	40 2 1/4"	36-60 °C	11,5	1	-
524900	50 2 3/4"	36-60 °C	15,0	1	-



\* Without recirculation connection





524

Connection kit for mixing valves with threaded connections, 524 series. Complete with:  
 - 2 female unions with check valves, strainers and seals;  
 - 1 female union with seal.



Code				
524004	1/2"	for 524400	1	-
524005	3/4"	for 524500	1	-
524006	1"	for 524600	1	-
524007	1 1/4"	for 524700	1	-
524008	1 1/2"	for 524800	1	-
524009	2"	for 524900	1	-

Code		Temperature adjustment	Kv (m³/h)		
524060	DN 65	36-53 °C (± 2 °C)	32,0	1	-
524080	DN 80	36-53 °C (± 2 °C)	43,0	1	-

Application diagram of mixing valve 524 series

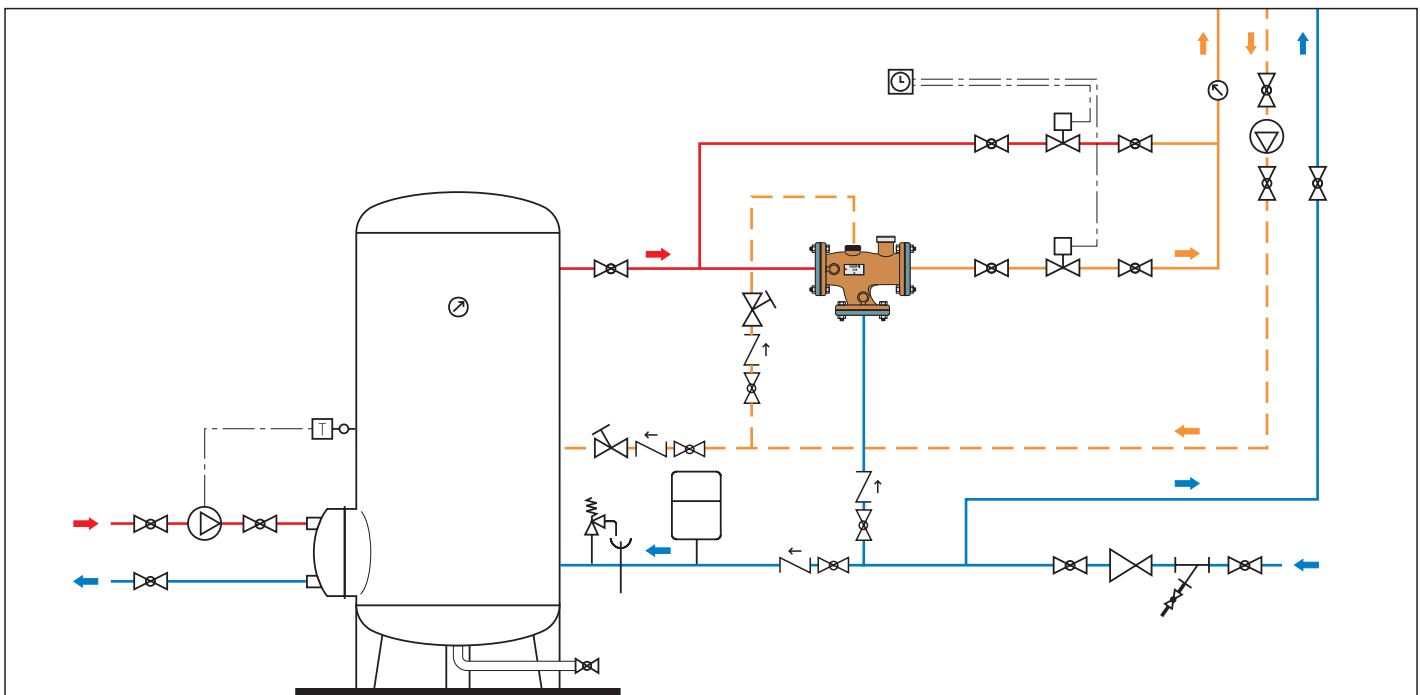

HYBRID ELECTRONIC MIXING VALVE

6000 LEGIOMIX® 2.0

tech. broch. 01334

Hybrid electronic mixing valve.

Complete with:

- hybrid mixing valve with motorised actuator
- electronic regulator with programming of temperature levels and thermal disinfection cycles, built into the actuator casing
- integrated flow temperature probe
- circuit return temperature probe
- flow temperature gauge.

Fitted for data saving function (optional), with recording of temperatures and functional parameters. Fitted for connection to remote control system (optional).

CR dezincification resistant alloy body.

Electric supply: 230 V - 50/60 Hz.

Max working pressure: 10 bar.

Max. inlet temperature: 90 °C.

Adjustment temperature range in mixing mode: 35–65 °C.

Disinfection temperature range: 50–85 °C.

Protection class: IP 54.

PATENT PENDING.



Code	Body DN	Conn.	Kv (m³/h)		
600045 EST	15	1/2"	4,3	1	–
600055 EST	20	3/4"	4,3	1	–
600065 EST	25	1"	7,6	1	–
600075 EST	32	1 1/4"	10,0	1	–
600085 EST	40	1 1/2"	13,0	1	–
600095 EST	50	2"	18,0	1	–



Spare parts for electronic mixing valve 6000 series, LEGIOMIX® 2.0.

Code

<b>F0000964</b>	body without unions for DN 15
<b>F0000965</b>	body without unions for DN 20
<b>F0000966</b>	body without unions for DN 25
<b>F0000967</b>	body without unions for DN 32
<b>F0000968</b>	body without unions for DN 40
<b>F0000969</b>	body without unions for DN 50

Operating principle

The electronic hybrid mixing valve combines the typical function of the mechanical thermostatic mixing valve and the management efficiency of an electronic mixing valve in a single device.

The thermostatic mixing valve uses the mechanical action performed by the internal control thermostatic element, which responds promptly to any variation in temperature, pressure and inlet flow rate to quickly restore the mixed water temperature value at the outlet.

Fast and accurate temperature control guaranteed, indispensable for use in domestic hot water distribution circuits.

This basic mixer is effectively managed by a motor-controlled actuator that, based on a signal coming from the temperature probes and under the control of a specific regulator, modifies the set point temperature of the mixed water. The latter is monitored continuously by means of temperature probes, which indicate the operation status of the domestic water circuit.

The electronic regulator, directly on the actuator, allows the mixed water temperature control according to different functional programs, both for normal control and for the thermal disinfection for the prevention of Legionella. This phase can be controlled and checked automatically in terms of temperatures and disinfection times, for optimal system management.

An optional memory system allows continuous recording of flow temperature, return temperature, alarm and functional statuses, useful for monitoring the operating status of the entire system.

Appropriate relays are used to manage the alarms and external appliances, for example for loading accumulation hot water and switching on/off the recirculation pump.

The regulator is fitted for remote control with specific MODBUS-RTU transmission protocols, through optional board, for use in Building Automation and Control Systems (BACS).

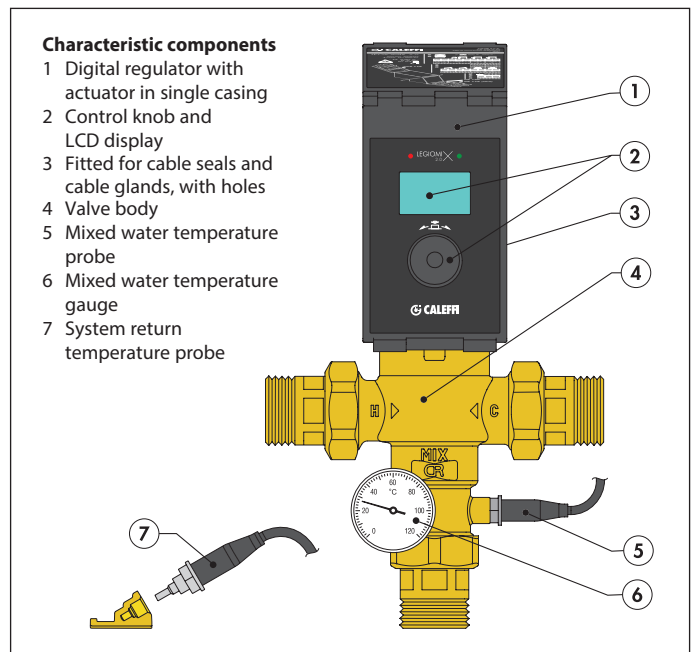

Characteristic components

- 1 Digital regulator with actuator in single casing
- 2 Control knob and LCD display
- 3 Fitted for cable seals and cable glands, with holes
- 4 Valve body
- 5 Mixed water temperature probe
- 6 Mixed water temperature gauge
- 7 System return temperature probe

Spare parts for electronic mixing valve 6000 series, LEGIOMIX® 2.0.

Code



<b>F69807</b>	mixed water probe for 1/2"–2"
<b>F69591</b>	recirculation probe for check on disinfection
<b>F69531</b>	contact probe holder for check on disinfection
<b>F29571</b>	temperature gauge 0–120 °C
<b>F0000970</b>	digital regulator with actuator for DN 15–DN 20
<b>F0000971</b>	digital regulator with actuator for DN 25–DN 50

ACCESSORIES FOR HYBRID ELECTRONIC MIXING VALVE

Code 600001

Optional board MODBUS-RTU transmission and logs

By installing the board on the device, it will be possible to manage the device through a specific MODBUS-RTU transmission protocol for use in Building Automation and Control Systems (BACS). The package includes the optional board, main board connection cable and logs.

Code			
600001	optional board and logs	1	-

Code 600002

RS-485 USB cable and Caleffi Software

Using the cable with RS-485 USB interface and the Caleffi Software included in the package, it is possible to manage the device from PC. The two Software are used to manage the mixing valves LEGIOMIX® 24 V and LEGIOMIX® 2.0.

Code			
600002	RS-485 USB cable and Caleffi Software	1	-

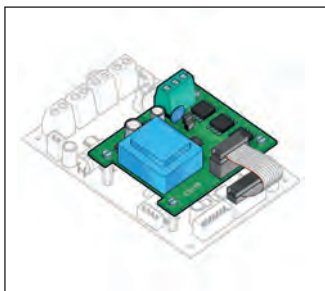
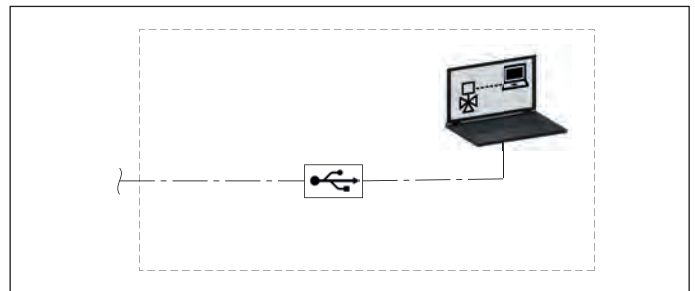
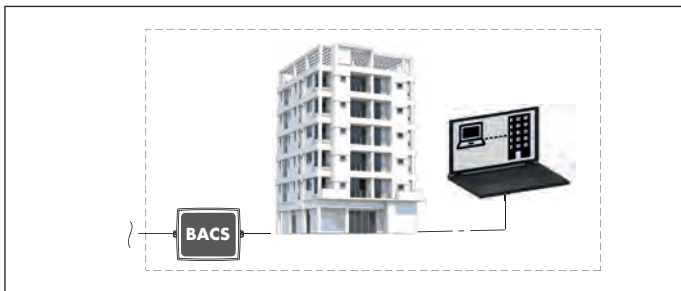

BEG	TYPE	DESCRIPTION	READ	VALUE
0001	0001	0001	0001	0001
0002	0002	0002	0002	0002
0003	0003	0003	0003	0003
0004	0004	0004	0004	0004
0005	0005	0005	0005	0005
0006	0006	0006	0006	0006
0007	0007	0007	0007	0007
0008	0008	0008	0008	0008
0009	0009	0009	0009	0009
0010	0010	0010	0010	0010
0011	0011	0011	0011	0011
0012	0012	0012	0012	0012
0013	0013	0013	0013	0013
0014	0014	0014	0014	0014
0015	0015	0015	0015	0015
0016	0016	0016	0016	0016
0017	0017	0017	0017	0017
0018	0018	0018	0018	0018
0019	0019	0019	0019	0019
0020	0020	0020	0020	0020
0021	0021	0021	0021	0021
0022	0022	0022	0022	0022
0023	0023	0023	0023	0023
0024	0024	0024	0024	0024
0025	0025	0025	0025	0025
0026	0026	0026	0026	0026
0027	0027	0027	0027	0027
0028	0028	0028	0028	0028
0029	0029	0029	0029	0029
0030	0030	0030	0030	0030
0031	0031	0031	0031	0031
0032	0032	0032	0032	0032
0033	0033	0033	0033	0033
0034	0034	0034	0034	0034
0035	0035	0035	0035	0035
0036	0036	0036	0036	0036
0037	0037	0037	0037	0037
0038	0038	0038	0038	0038
0039	0039	0039	0039	0039
0040	0040	0040	0040	0040
0041	0041	0041	0041	0041
0042	0042	0042	0042	0042
0043	0043	0043	0043	0043
0044	0044	0044	0044	0044
0045	0045	0045	0045	0045
0046	0046	0046	0046	0046
0047	0047	0047	0047	0047
0048	0048	0048	0048	0048
0049	0049	0049	0049	0049
0050	0050	0050	0050	0050
0051	0051	0051	0051	0051
0052	0052	0052	0052	0052
0053	0053	0053	0053	0053
0054	0054	0054	0054	0054
0055	0055	0055	0055	0055
0056	0056	0056	0056	0056
0057	0057	0057	0057	0057
0058	0058	0058	0058	0058
0059	0059	0059	0059	0059
0060	0060	0060	0060	0060
0061	0061	0061	0061	0061
0062	0062	0062	0062	0062
0063	0063	0063	0063	0063
0064	0064	0064	0064	0064
0065	0065	0065	0065	0065
0066	0066	0066	0066	0066
0067	0067	0067	0067	0067
0068	0068	0068	0068	0068
0069	0069	0069	0069	0069
0070	0070	0070	0070	0070
0071	0071	0071	0071	0071
0072	0072	0072	0072	0072
0073	0073	0073	0073	0073
0074	0074	0074	0074	0074
0075	0075	0075	0075	0075
0076	0076	0076	0076	0076
0077	0077	0077	0077	0077
0078	0078	0078	0078	0078
0079	0079	0079	0079	0079
0080	0080	0080	0080	0080
0081	0081	0081	0081	0081
0082	0082	0082	0082	0082
0083	0083	0083	0083	0083
0084	0084	0084	0084	0084
0085	0085	0085	0085	0085
0086	0086	0086	0086	0086
0087	0087	0087	0087	0087
0088	0088	0088	0088	0088
0089	0089	0089	0089	0089
0090	0090	0090	0090	0090
0091	0091	0091	0091	0091
0092	0092	0092	0092	0092
0093	0093	0093	0093	0093
0094	0094	0094	0094	0094
0095	0095	0095	0095	0095
0096	0096	0096	0096	0096
0097	0097	0097	0097	0097
0098	0098	0098	0098	0098
0099	0099	0099	0099	0099
0100	0100	0100	0100	0100



Application diagram of electronic mixing valve 6000 EST LEGIOMIX® 2.0 series

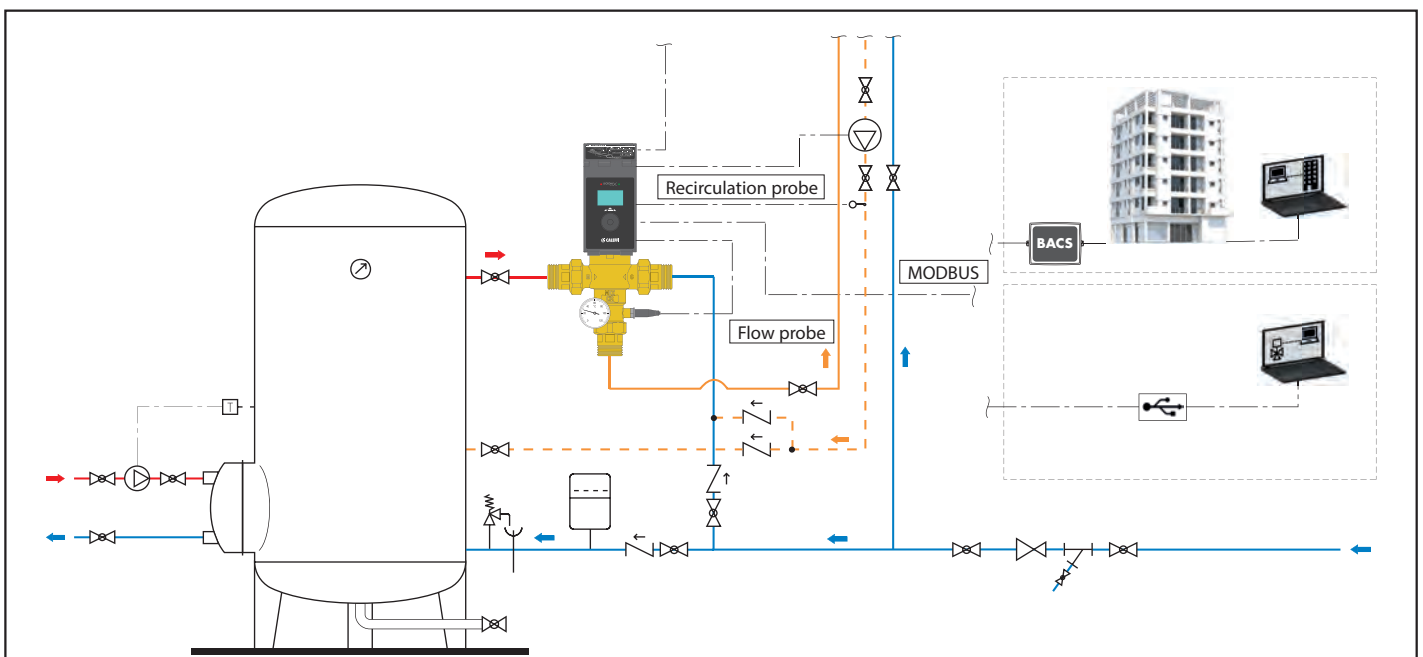

ELECTRONIC MIXING VALVE WITH THERMAL DISINFECTION - 230 V

6000 LEGIOMIX®

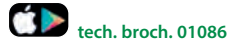

tech. broch. 01086

Electronic mixing valve with programmable thermal disinfection and check on disinfection. Male threaded connections with union.

Consisting of:

- three-way ball valve,
- actuator,
- regulator,
- flow temperature probe,
- return temperature probe.

With auxiliary microswitches for disinfection management and other devices.

Electric supply: 230 V - 50/60 Hz - (6,5+6) VA.

Max. working pressure: 10 bar.

Max. inlet temperature: 100 °C.

Adjustment temperature range: 20–85 °C.

Disinfection temperature range: 40–85 °C.

Protection class: IP 65 (actuator).

PATENT.



Function

This particular series of electronic mixing valves is equipped with a special regulator **that controls a set of programs for circuit thermal disinfection**. In addition it enables checking the temperature and time for thermal disinfection are actually reached and undertaking the appropriate corrective action. All the parameters are updated every day and logged, recording the temperatures by time.

Spare parts for mixing valve.

Consisting of:

- three-way ball valve,
- actuator,
- flow temperature probe,
- temperature gauge,
- holder accessories fitting.

Code

600251	for code 600051
600261	for code 600061
600271	for code 600071
600281	for code 600081
600291	for code 600091

Spare parts for electronic mixing valve with programmable thermal disinfection 6000 series with threaded connections, 230 V.

Code

645112	actuator 230 V (AC) for 600051–600091
F69798	valve body without unions and probe holder for 3/4"
F69799	valve body without unions and probe holder for 1"
F69801	valve body without unions and probe holder for 1 1/4"
F69803	valve body without unions and probe holder for 1 1/2"-2"
F69807	flow probe for 3/4"-1"-1 1/4"
F69804	flow probe for 1 1/2"-2"
F69591	recirculation probe for check on disinfection
F69531	contact probe holder for recirculation loop
F69433	regulator with check on disinfection
R19101	temperature gauge 0–80 °C
F69752	electronic board
F69888	spare battery

Code		Kv (m³/h)		
600051	3/4"	8,4	1	–
600061	1"	10,6	1	–
600071	1 1/4"	21,2	1	–
600081	1 1/2"	32,5	1	–
600091	2"	41,0	1	–

ANTI-SCALD DEVICE

6001

tech. broch. 01086

Anti-scald device for domestic hot water use. Brass body. Chrome plated. Setting temperature: 48 °C (± 1 °C).



Function

The purpose of the anti-scald device is to cut off the flow of water if its temperature reaches the setting value. Designed to be used in domestic hot water systems with electronic mixing valves with programmable thermal disinfection. Installed directly at the point of use, it prevents the hot water from scalding the user during the thermal disinfection period (T>50 °C).

Code			
600140	1/2"	1	10

ELECTRONIC MIXING VALVE WITH THERMAL DISINFECTION - 230 V

6000 LEGIOMIX®



tech. broch. 01086

Spare parts for electronic mixing valve with programmable thermal disinfection 6000 series with flanged connections.

Electronic mixing valve with programmable thermal disinfection and check on disinfection. Flanged connection PN 16. Consisting of:

- three-way ball valve,
- actuator,
- regulator,
- flow temperature probe,
- return temperature probe.

With auxiliary microswitches for disinfection management and other devices.

Electric supply: 230 V - 50/60 Hz - (6,5+10,5) VA.

Max. working pressure: 10 bar.

Max. inlet temperature: 100 °C.

Adjustment temperature range: 20–85 °C.

Disinfection temperature range: 40–85 °C.

To be coupled with counterflanges EN 1092-1.

Protection class: IP 65 (actuator).

PATENT.

Code

<b>F69381</b>	flow temperature probe
<b>F69393</b>	three-way valve with flanged connections for codes 6000.6
<b>F69394</b>	three-way valve with flanged connections for codes 6000.8
<b>F69395</b>	actuator 230 V (AC) for codes 600006 and 600008
<b>F69433</b>	regulator with check on disinfection
<b>F69591</b>	recirculation probe for check on disinfection
<b>F69531</b>	contact probe holder for recirculation loop
<b>F69888</b>	spare battery



Code		Kv (m³/h)		
<b>600006</b>	DN 65	90,0	1	-
<b>600008</b>	DN 80	105,0	1	-

Application diagram of electronic mixing valve 6000 series

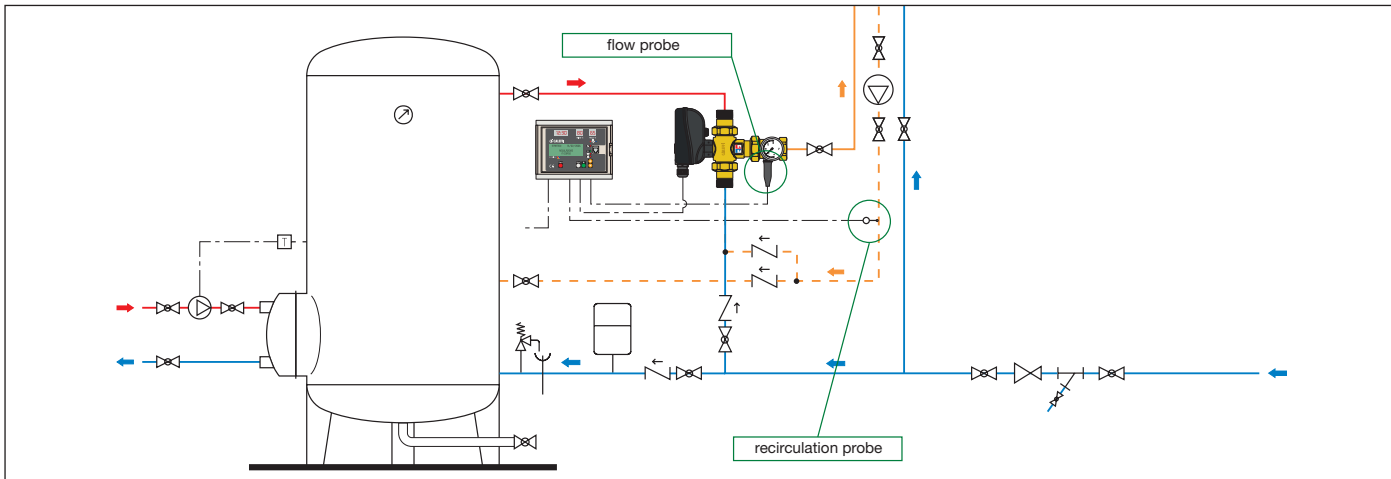

**ELECTRONIC MIXING VALVE WITH THERMAL DISINFECTION - 24 V**  
 Suitable for BACS with MODBUS-RTU management

**6000 LEGIOMIX®**



Electronic mixing valve with programmable thermal disinfection and check on disinfection. Male threaded connections with union. Consisting of:

- three-way ball valve,
- actuator,
- regulator,
- flow temperature probe,
- return temperature probe.

With auxiliary microswitches for disinfection management and other devices. Fitted for remote control connection with RS-485 and MODBUS-RTU protocols. Electric supply: 24 V - 50/60 Hz - (6,5+6) VA. Max. working pressure: 10 bar. Max. inlet temperature: 100 °C. Adjustment temperature range: 20–85 °C. Disinfection temperature range: 40–85 °C. Protection class: IP 65 (actuator). PATENT.



Code		Kv (m³/h)		
600054	3/4"	8,4	1	-
600064	1"	10,6	1	-
600074	1 1/4"	21,2	1	-
600084	1 1/2"	32,5	1	-
600094	2"	41,0	1	-

**Function**

This particular series of electronic mixing valves is equipped with a special regulator **that controls a set of programs for circuit thermal disinfection.** In addition it enables checking the temperature and time for thermal disinfection are actually reached and undertaking the appropriate corrective action. All the parameters are updated every day and logged, recording the temperatures by time.

Spare parts for electronic mixing valve with programmable thermal disinfection 6000 series with threaded connections, 24 V.

Code

645114	actuator 24 V (AC) for 600054–600094
F69798	valve body without unions and probe holder for 3/4"
F69799	valve body without unions and probe holder for 1"
F69801	valve body without unions and probe holder for 1 1/4"
F69803	valve body without unions and probe holder for 1 1/2"-2"
F69807	flow probe for 3/4"-1"-1 1/4"
F69804	flow probe for 1 1/2"-2"
F69591	recirculation probe for check on disinfection
F69531	contact probe holder for recirculation loop
F0000961	regulator with check on disinfection
R19101	temperature gauge 0–80 °C
F69888	spare battery

**Code 600002**

**RS-485 USB cable and Caleffi Software**

Using the cable with RS-485 USB interface and the Caleffi Software included in the package, it is possible to manage the device from PC. The two Software are used to manage the mixing valves LEGIOMIX® 24 V and LEGIOMIX® 2.0.

Code

600002	RS-485 USB cable and Caleffi Software	1	-
--------	---------------------------------------	---	---

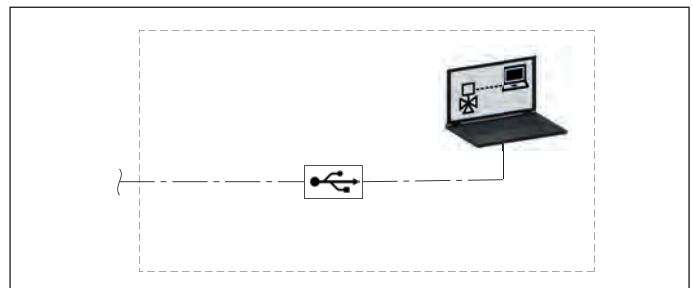



**ELECTRONIC MIXING VALVE WITH THERMAL DISINFECTION - 24 V**  
 Suitable for BACS with MODBUS-RTU management

**6000 LEGIOMIX®**



Electronic mixing valve with programmable thermal disinfection and check on disinfection. Flanged connection PN 16. Consisting of:  
 - three-way ball valve,  
 - actuator,  
 - regulator,  
 - flow temperature probe,  
 - return temperature probe.

With auxiliary microswitches for disinfection management and other devices. Fitted for remote control connection with RS-485 and MODBUS-RTU protocols. Electric supply: 24 V - 50/60 Hz - (6,5+10,5) VA. Max. working pressure: 10 bar. Max. inlet temperature: 100 °C. Adjustment temperature range: 20–85 °C. Disinfection temperature range: 40–85 °C. To be coupled with counterflanges EN 1092-1. Protection class: IP 65 (actuator). PATENT.



Code		Kv (m³/h)		
600016	DN 65	90,0	1	-
600018	DN 80	105,0	1	-

Spare parts for electronic mixing valve with programmable thermal disinfection 6000 series with flanged connections.

Code

F69381	flow temperature probe
F69393	three-way valve with flanged connections for codes 6000.6
F69394	three-way valve with flanged connections for codes 6000.8
F000095	actuator 24 V (AC) for codes 600016 and 600018
F000091	regulator with check on disinfection
F69591	recirculation probe for check on disinfection
F69531	contact probe holder for recirculation loop
F69888	spare battery

**7550**

MODBUS-RTU/BACnet converter for connection with BACS systems. Interface for products with MODBUS-RTU transmission with systems using BACnet protocol.

Supply:  
 9–30 V (dc), 12–24 V (AC), 50/60 Hz  
 2,5 W / a 12 V 150 mA.  
 Certification: CE, IEC, FCC, RHOS.  
 Inputs/Outputs:  
 Ethernet port 10/100  
 RS-485 port + / - / GND.  
 Working temperature: -40–75 °C.  
 Relative humidity: 5–90 % without condensation.



The converter is preconfigured for use with the following products:  
 - LEGIOMIX® 6000 series (for MODBUS-RTU version)  
 - LEGIOMIX® 2.0 6000 EST series  
 - CONTECA EASY 750. series.



Code		
755052	1	-

Application diagram of electronic mixing valve 6000 series

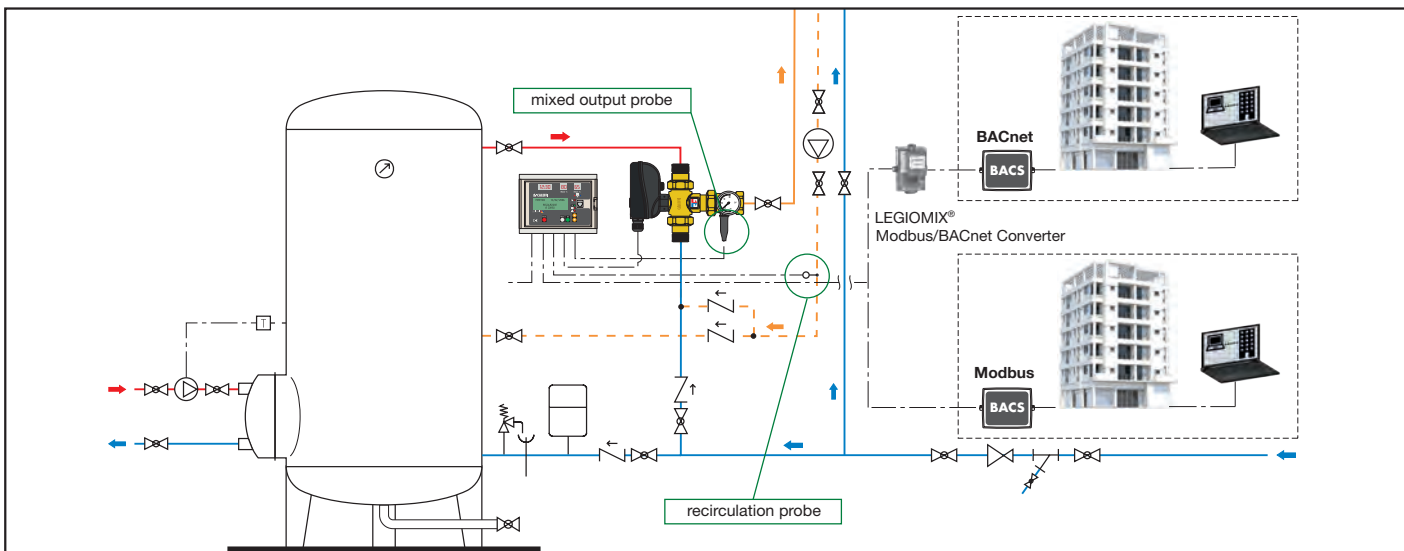

UNIT FOR TEMPERATURE CONTROL AND THERMAL DISINFECTION

6005 LEGIOFLOW®

tech. broch. 01160

Multi-function compact unit for temperature control, thermal disinfection and distribution for domestic water system. Consisting of:

- anti-scald thermostatic mixing valve,
- automatic flushing valve for thermal disinfection with thermo-electric actuator,
- shut-off ball valve with built-in strainers and check valves,
- cold water circuit outlet kit, with integral check valves.

Inlet connections: 3/4" M.  
Outlet connections: 3/4" M with union.



**Mixing valve**  
 CR dezincification resistant alloy body.  
 Max. working pressure: 10 bar.  
 Adjustment temperature range: 30–50 °C.  
 Factory setting: 43 °C.  
 Max. inlet temperature at primary circuit: 85 °C.  
 Performance to standards NF 079 doc. 8, EN 1111 and EN 1287.

**Thermo-electric actuator**  
 Normally closed.  
 Supply: 230 V (AC).  
 Power consumption: 3 W.  
 Protection class: IP 44.  
 Cable length: 80 cm.



With thermo-electric actuator

Code	Connections	Kv (m³/h) mixing valve	Kv (m³/h) flushing valve		
600500	3/4"	1,75	1,80	1	6

Without thermo-electric actuator

Code	Connections	Kv (m³/h) mixing valve	Kv (m³/h) flushing valve		
600501	3/4"	1,75	1,80	1	6

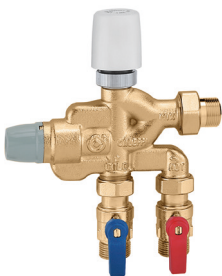

**Version without cold water circuit outlet kit. With shut-off ball valves with strainers and check valves.**

For applications with push button or photo-cell activated user taps.



With thermo-electric actuator

Code	Connections	Kv (m³/h) mixing valve	Kv (m³/h) flushing valve		
600502	3/4"	1,75	1,80	1	6

Without thermo-electric actuator

Code	Connections	Kv (m³/h) mixing valve	Kv (m³/h) flushing valve		
600503	3/4"	1,75	1,80	1	6

6005 LEGIOFLOW®

tech. broch. 01160

Multi-function compact unit for temperature control, thermal disinfection and distribution for domestic water system. Consisting of:

- anti-scald thermostatic mixing valve,
- automatic flushing valve for thermal disinfection with thermo-electric actuator,
- shut-off ball valve with built-in strainers and check valves,
- cold water circuit outlet kit,
- distribution manifolds with built-in shut-off valves,
- box code 362056 (560x330x80 mm).

**Mixing valve**  
 CR dezincification resistant alloy body.  
 Max. working pressure: 10 bar.  
 Adjustment temperature range: 30–50 °C.  
 Factory set: 43 °C.  
 Max. inlet temperature at primary circuit: 85 °C.  
 Performance to standards NF 079 doc. 8, EN 1111 and EN 1287.

**Thermo-electric actuator**  
 Normally closed.  
 Supply: 230 V (ac).  
 Power consumption: 3 W.  
 Protection class: IP 44.  
 Cable length: 80 cm.

**Distribution manifolds**  
 CR dezincification resistant alloy body.  
 Max. working pressure: 10 bar.  
 Working temperature range: 5–100 °C.  
 Outlet centre distance: 35 mm.

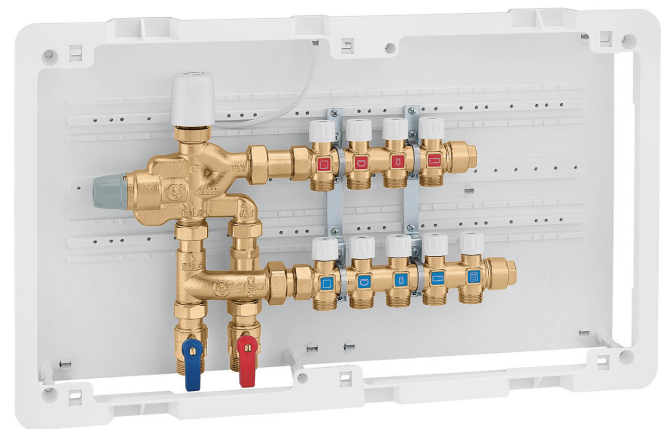

With thermo-electric actuator

Code	Connections	Outlets No. cold hot	Outlets		
600530	3/4"	3 2	23 p.1,5 M	1	–
600540	3/4"	4 3	23 p.1,5 M	1	–
600550	3/4"	5 4	23 p.1,5 M	1	–

Without thermo-electric actuator

Code	Connections	Outlets No. cold hot	Outlets		
600531	3/4"	3 2	23 p.1,5 M	1	–
600541	3/4"	4 3	23 p.1,5 M	1	–
600551	3/4"	5 4	23 p.1,5 M	1	–

UNIT FOR TEMPERATURE CONTROL AND THERMAL DISINFECTION

Thermal disinfection

To be more certain that there is no growth of Legionella, all sections of the network must be subjected to thermal disinfection. Even in the section downstream of the mixing valve, as far as the user tap, it must be possible to flush the system at temperatures exceeding 60 °C. This means by-passing the thermostatic mixing valve, which is set at lower values, and activating another valve that allows the taps to be fed directly with the hot water arriving from the distribution network.

Function

The multi-function unit is used in domestic water systems to control the hot and cold water delivered to user taps, serving a bathroom or a dwelling. A high-performance adjustable thermostatic mixing valve keeps the hot water temperature at the desired level and protects the user from the danger of scalding.

A flushing valve is used for the circuit thermal disinfection all the way to the tap, in compliance with anti-Legionella regulations.

Hydraulic diagram

With mixing

- Flushing valve closed
- Cold water valve open

With thermal disinfection

- Flushing valve open
- Cold water valve closed

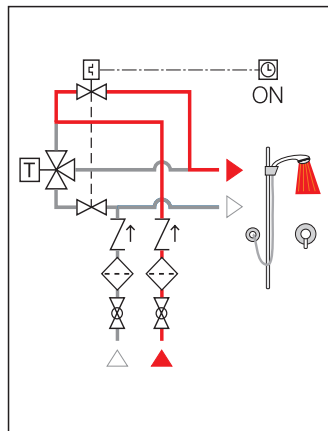
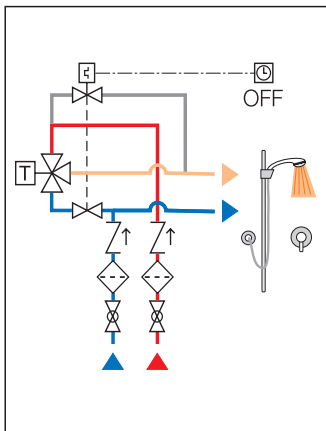

Temperature adjustment

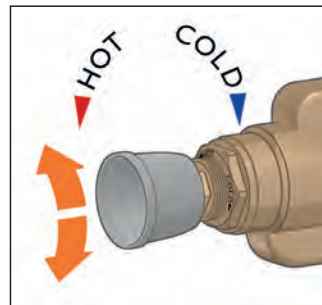

Adjustment locking using the locking nut

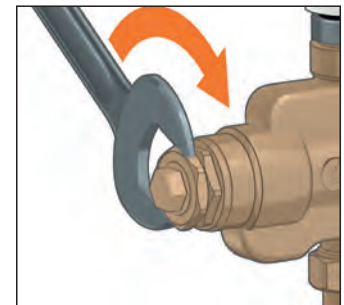

Manual opening

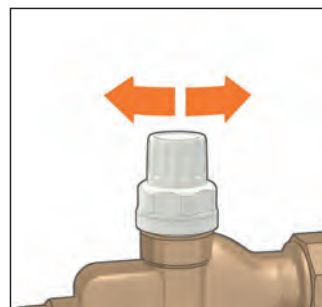

Thermo-electric actuator

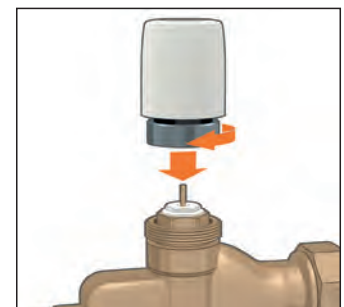

Application diagram multi-function unit code 600550

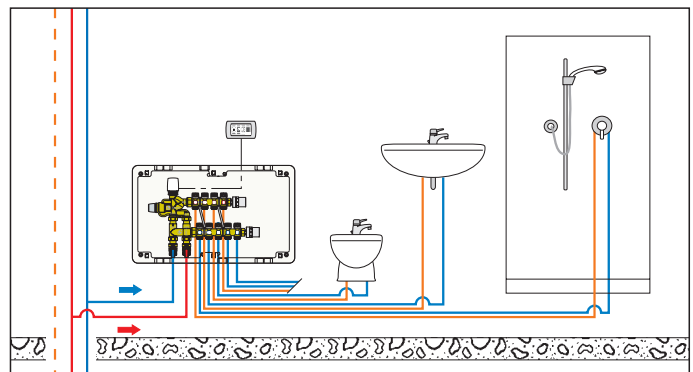

TIMER FOR VALVE OPERATION

6002

Timer with programmable key, settings from 0,25 to 15 minutes. To operate the valves used to carry out thermal disinfection of circuit sections, up to the taps. Supply: 230 V (AC).



Code

600200



1

-

MULTI-FUNCTION THERMOSTATIC REGULATOR



**116** tech. broch. 01325  
 Thermostatic regulator for domestic hot water recirculation circuits. Complete with automatic thermostatic thermal disinfection function. With temperature gauge for circuit temperature check. **CR** dezincification resistant alloy body "LOW LEAD". Female connections. Max. working pressure: 16 bar. Disinfection temperature: 70°C.



Code	DN	Conn.	Temperature adjustment		
116240	15	Rp 1/2"	35–60 °C	1	10
116250	20	Rp 3/4"	35–60 °C	1	10
116260	25	Rp 1"	35–65 °C	1	–
116270	32	Rp 1 1/4"	35–65 °C	1	–



**116** tech. broch. 01325  
 Thermostatic regulator for domestic hot water recirculation circuits. Fitted for automatic or controlled thermal disinfection function. With pocket for temperature gauge. **CR** dezincification resistant alloy body "LOW LEAD". Female connections. Max. working pressure: 16 bar.



Code	DN	Conn.	Temperature adjustment		
116140	15	Rp 1/2"	35–60 °C	1	10
116150	20	Rp 3/4"	35–60 °C	1	10
116160	25	Rp 1"	35–65 °C	1	–
116170	32	Rp 1 1/4"	35–65 °C	1	–



Insulation for multifunction thermostatic regulator 116 series.

Code	Use		
CBN116140	1/2" - 3/4"	1	20
CBN116160	1" - 1 1/4"	1	20



**116** tech. broch. 01325  
 Cartridge for thermal disinfection function controlled by an actuator. For use with 116 series combined with 656 series actuators.

Code		
116000	1	10



**116** tech. broch. 01325  
 Accessory temperature gauge for thermostatic regulators 116 series. Temperature gauge scale: 0–80 °C.

Code		
116010	1	20

Function

In domestic hot water distribution circuits, to respect modern plant requirements for the prevention of Legionnaires' disease, it is essential to ensure that all sections are kept at the correct temperature. The recirculation network must be balanced, to avoid non-uniform temperature distribution, with cold sections at risk of Legionella proliferation. The thermostatic regulator, installed on each return branch of the recirculation circuit, automatically maintains the set temperature. This device modulates the medium flow rate in accordance with the water inlet temperature by means of the action of a dedicated internal thermostatic cartridge. When the water temperature approaches the set value, the obturator progressively reduces the passage. The medium flow rate supplied by the recirculation pump is thus distributed to the other network branches, resulting in effective automatic thermal balancing. If necessary, the regulator is already equipped with a thermal disinfection function, which is useful if the system temperature is to be increased to values over 55–60 °C. This function can be completely automatic, activated by a dedicated second thermostatic cartridge that trips at 70 °C, or controlled with a thermo-electric actuator.

Cartridge replacement for electrically controlled disinfection

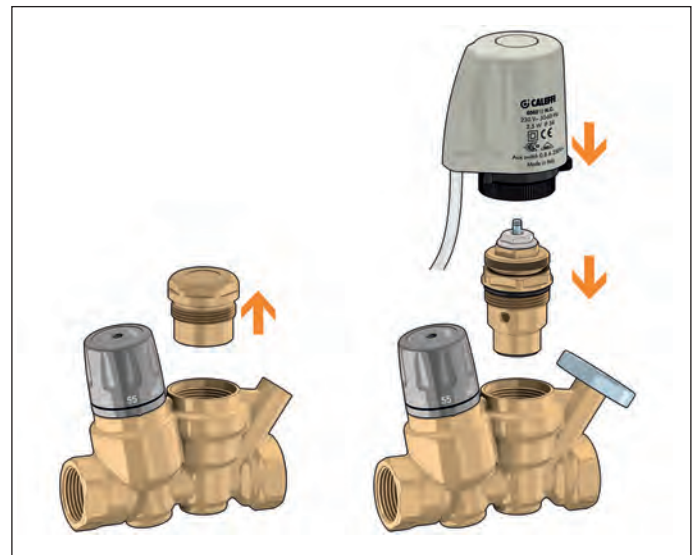

Application diagram of thermostatic regulator 116 series

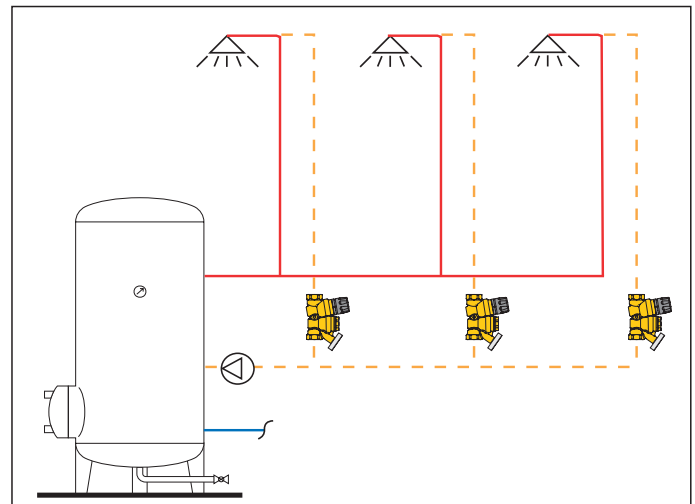

MULTI-FUNCTION THERMOSTATIC REGULATOR

Operating modes

Here following the regulator's operating modes according to the variation of the water temperature of the circuit it is installed on.

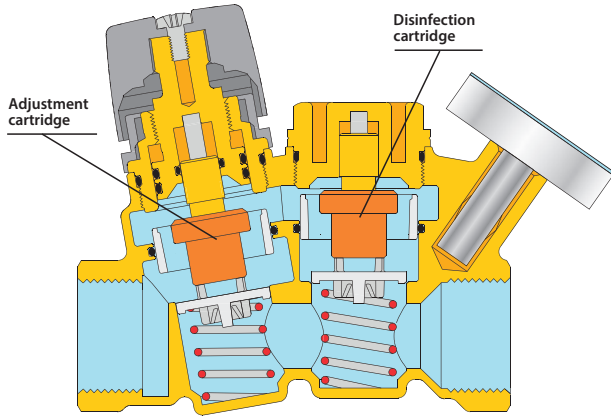
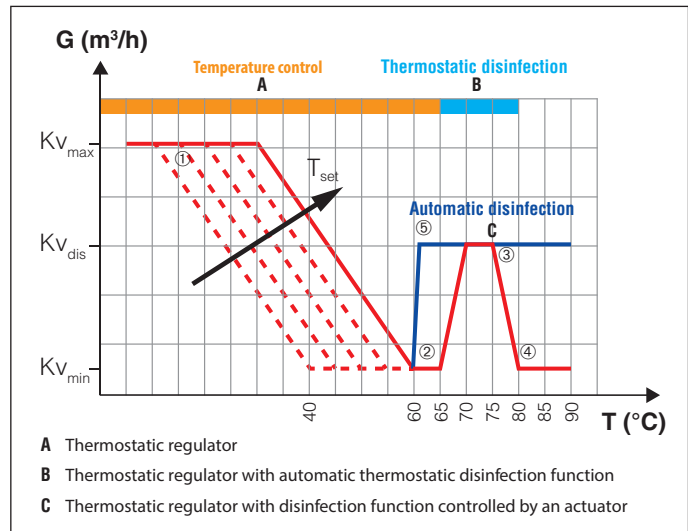

Diagram of thermostatic regulator 116 series



Thermostatic adjustment

Minimum flow rate

Thermostatic disinfection

Thermal closing

Electrically controlled disinfection

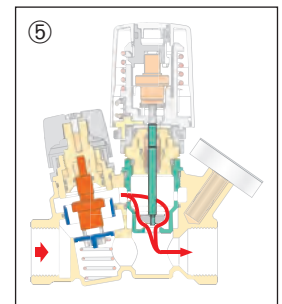
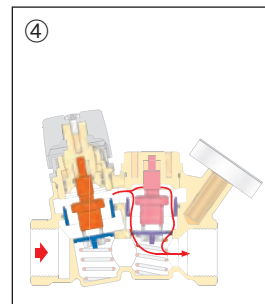
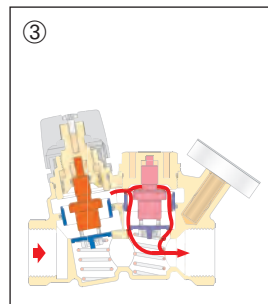
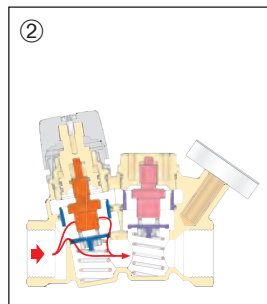
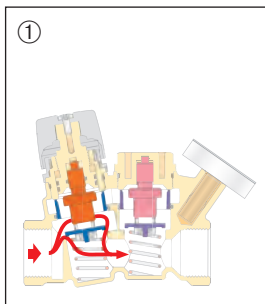

**116**  
Thermostatic regulator for domestic hot water recirculation circuits. Complete with automatic thermostatic thermal disinfection function. With temperature gauge for circuit temperature check. **CR** dezincification resistant alloy body "LOW LEAD". Female connections. Max. working pressure: 16 bar. Disinfection temperature: 70 °C.

**W**  
Lead Free  
WMTS-468  
WM-40195



**116**  
Thermostatic regulator for domestic hot water recirculation circuits. Fitted for automatic or controlled thermal disinfection function. With temperature gauge. **CR** dezincification resistant alloy body "LOW LEAD". Female connections. Max. working pressure: 16 bar.

**W**  
Lead Free  
WMTS-468  
WM-40195

Code	DN	Conn.	Temperature adjustment		
116240 AUS	15	1/2"	35-60 °C	1	-
116250 AUS	20	3/4"	35-60 °C	1	-

Code	DN	Conn.	Temperature adjustment		
116141 AUS	15	1/2"	40-65 °C	1	-
116151 AUS	20	3/4"	40-65 °C	1	-
116140 AUS*	15	1/2"	40-65 °C	1	-
116150 AUS*	20	3/4"	40-65 °C	1	-

\*Without temperature gauge

**THERMOSTATIC REGULATOR WITH BUILT-IN CHECK VALVE**



**116** **NEW**

Thermostatic regulator **with built-in check valve** for domestic hot water recirculation circuits. Complete with automatic thermostatic thermal disinfection function. With temperature gauge for circuit temperature check. CR dezincification resistant alloy body "LOW LEAD". Male union connections. Max. working pressure: 16 bar. Disinfection temperature: 70°C.



Code	DN	Conn.	Temperature adjustment		
116244	15	1/2"	35-60 °C	1	10
116254	20	3/4"	35-60 °C	1	10

**Features**

The thermostatic regulator with check valve built into the body can prevent unwanted medium return to ensure correct installation. The union connections are equipped with an O-Ring coupling to ensure maximum sealing reliability.

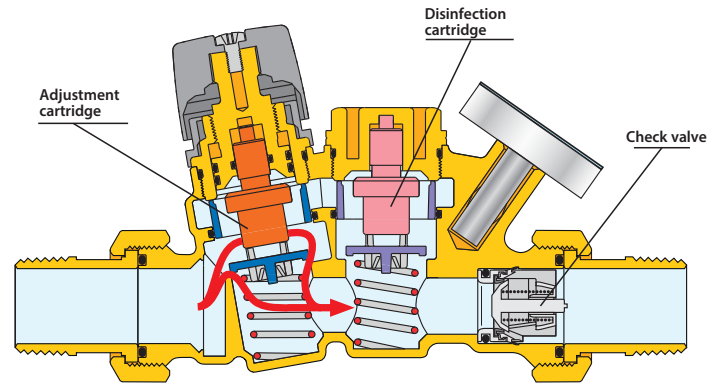

**116** **NEW**

Thermostatic regulator **with built-in check valve** for domestic hot water recirculation circuits. Fitted for automatic or controlled thermal disinfection function. With pocket for temperature gauge. CR dezincification resistant alloy body "LOW LEAD". Male union connections. Max. working pressure: 16 bar.



Code	DN	Conn.	Temperature adjustment		
116144	15	1/2"	35-60 °C	1	10
116154	20	3/4"	35-60 °C	1	10



**116**

tech. broch. 01325

Cartridge for thermal disinfection function controlled by an actuator. For use with 116 series combined with 656 series actuators.

Code		
116000	1	10



**116**

tech. broch. 01325

Accessory temperature gauge for thermostatic regulators 116 series. Temperature gauge scale: 0-80 °C.



Insulation for multifunction thermostatic regulator 116 series.

Code		
116010	1	20

Code	Use		
CBN116140	1/2" - 3/4"	1	20

**Application diagram of thermostatic regulator with built-in check valve 116 series**

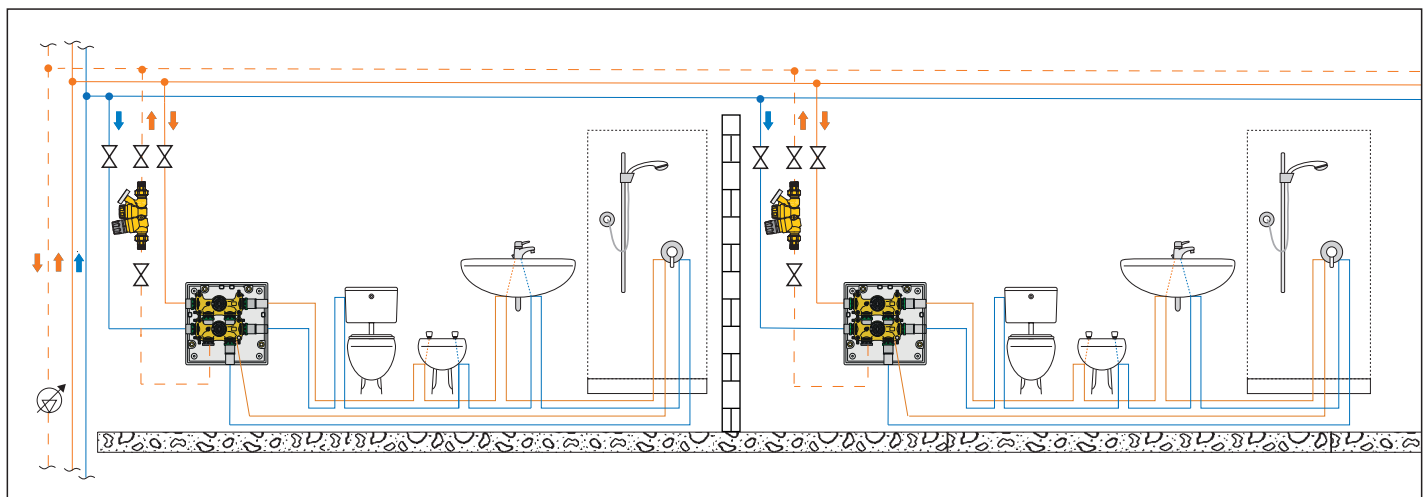

**THERMOSTATIC REGULATOR FOR DOMESTIC HOT WATER RECIRCULATION CIRCUITS**



**116** tech. broch. 01362  
 Thermostatic regulator for domestic hot water recirculation circuits. With temperature gauge for circuit temperature check.  
**CR** dezincification resistant alloy body "LOW LEAD".  
 Female connections.  
 Max. working pressure: 16 bar.



Code	DN	Conn.	Temperature adjustment		
116441	15	Rp 1/2"	40-65 °C	1	20
116451	20	Rp 3/4"	40-65 °C	1	20
116451 AUS*	20	Rp 3/4"	40-65 °C	1	20

\* With WATERMARK certification



**116** tech. broch. 01362  
 Thermostatic regulator for domestic hot water recirculation circuits. With pocket for temperature gauge.  
**CR** dezincification resistant alloy body "LOW LEAD".  
 Female connections.  
 Max. working pressure: 16 bar.



Code	DN	Conn.	Temperature adjustment		
116440	15	Rp 1/2"	40-65 °C	1	10
116450	20	Rp 3/4"	40-65 °C	1	10



**116** tech. broch. 01362  
 Thermostatic regulator for domestic hot water recirculation circuits. With pocket for temperature gauge.  
**CR** dezincification resistant alloy body "LOW LEAD".  
 Compression fittings connections.  
 Max. working pressure: 16 bar.



Code	DN	Conn.	Temperature adjustment		
116415	15	Ø 15	40-65 °C	1	10
116420	20	Ø 22	40-65 °C	1	10



Insulation for 1/2" and 3/4" multifunction thermostatic regulator 116 series.

Code	Use		
<b>CBN116440</b>	1/2" - 3/4"	1	20



**116** tech. broch. 01325  
 Accessory temperature gauge for thermostatic regulators 116 series.  
 Temperature gauge scale: 0-80 °C.

Code		
116010	1	20

**Operating principle**

The thermostatic regulator, installed on each branch of the recirculation circuit, automatically maintains the set temperature. This device modulates the medium flow rate in accordance with the water inlet temperature by means of the action of a dedicated internal thermostatic cartridge. When the water temperature approaches the set value, the obturator progressively reduces the passage.  
 This specific version of the regulator has one single cartridge which allows the adjustment of the set temperature up to 65 °C.  
 This device can be used in cases where the temperature of the hot water network is constantly distributed at higher values, without the need to perform extra thermal disinfection.

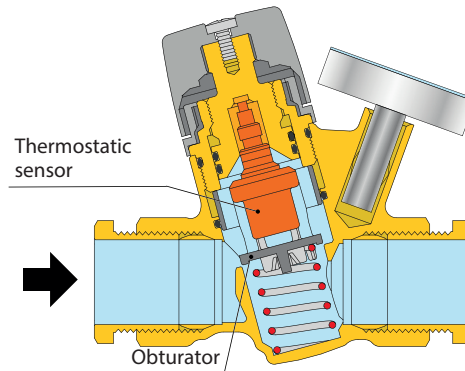

**Hydraulic characteristics**

The graph shows the variation of the Kv value depending on the device configuration and on the inlet temperature of the domestic water.

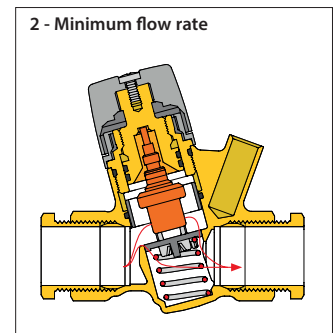
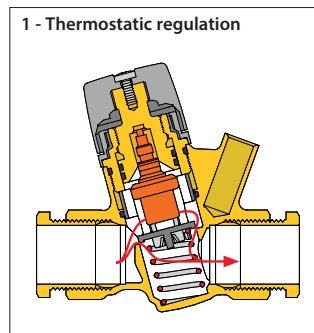
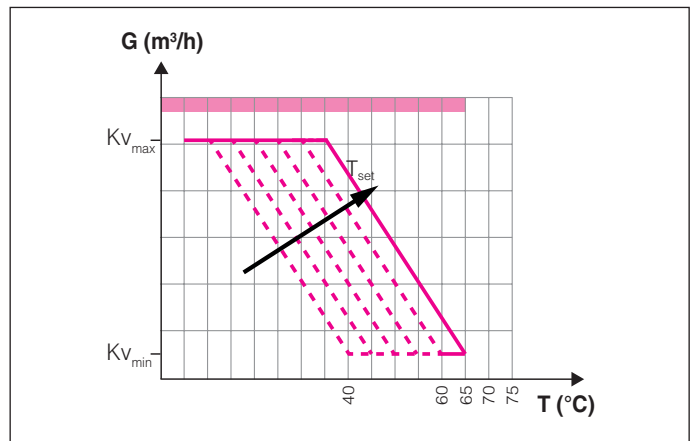





# MANIFOLDS FOR DOMESTIC WATER SYSTEMS

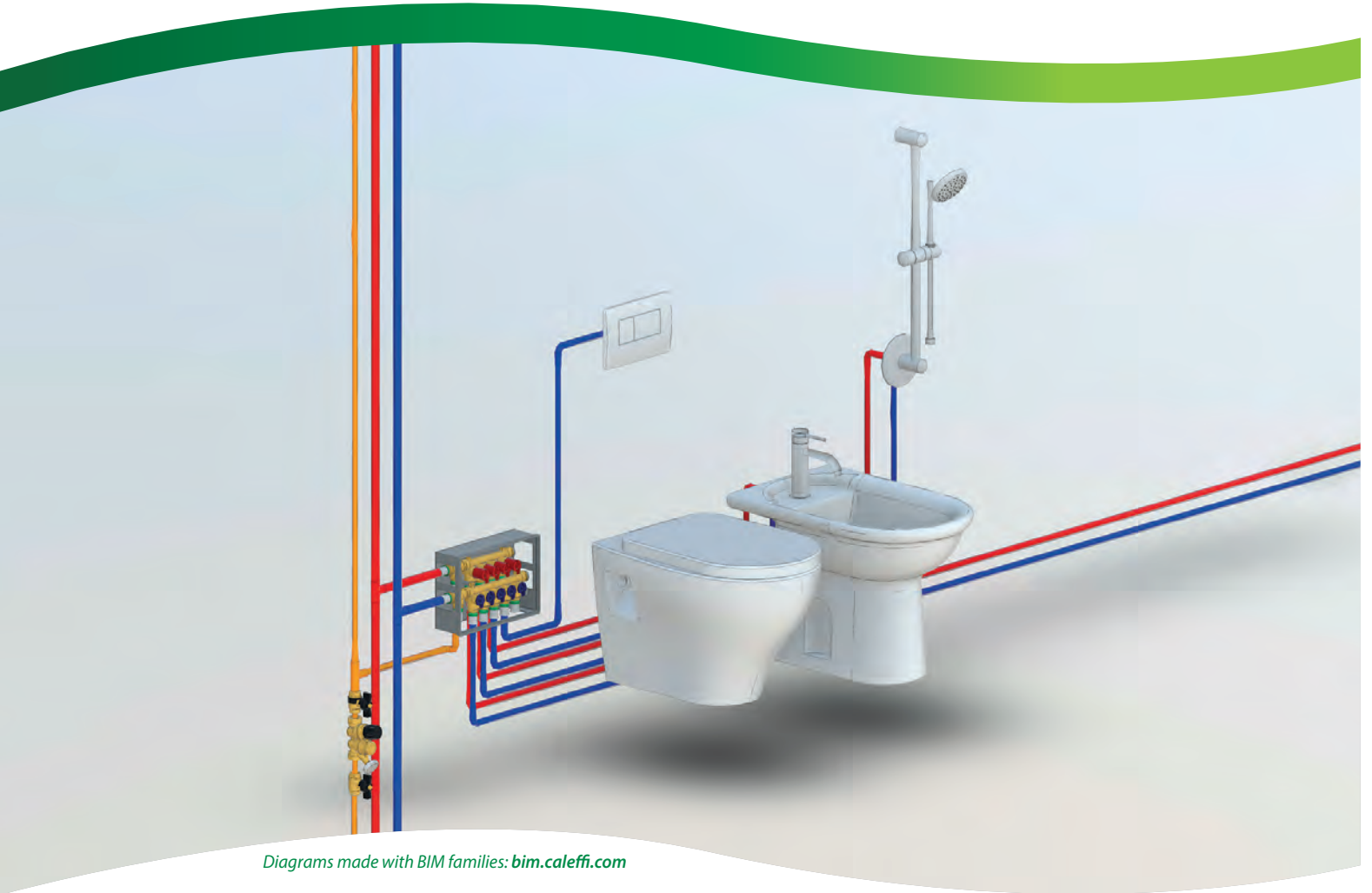

*Diagrams made with BIM families: [bim.caleffi.com](http://bim.caleffi.com)*

**Distribution manifolds with individual shut-off valves**  
**Distribution manifolds with main shut-off valves**  
**Unit with main shut-off valves**  
**Distribution manifolds**

DISTRIBUTION MANIFOLDS WITH INDIVIDUAL SHUT-OFF VALVES



359

tech. broch. 01371

Domestic water distribution manifolds pre-assembled in boxes with **individual shut-off valves**. Brass body.  
Max. working pressure: 10 bar.  
Temperature range: 5–90 °C.  
Outlet centre distance: 35 mm.

Consisting of:

- pair of manifolds with shut-off knobs;
- box for manifolds (270 x 190 x 80 mm) complete with manifold supports and fixing brackets;
- protection cover for installation;
- 2 end fitting plugs with fixing clips.

PATENT PENDING.

Code	Outlets No.			
	cold	hot		
359410*	4	3	1	-
359510*	5	4	1	-

\* CR dezincification resistant alloy body "LOW LEAD" available on request with the code extension: 001.



359

tech. broch. 01371

Accessories for manifolds series 359.

Code			
359001	tee with fixing clip	1	-
359002	blind plug with fixing clip	1	-
359003	23 p.1,5 fitting with fixing clip	1	-
359004	1/2" fitting Ø 13 flat seat with fixing clip	1	-
359005	3/4" fitting Ø 18 flat seat with fixing clip	1	-
359006	3/4" fitting Ø 18 Euroconus with fixing clip	1	-
359024	Ø 16x2 pressfitting	1	-
359064	Ø 20x2 pressfitting	1	-
359025	Ø 16x2,25 pressfitting	1	-
359065	Ø 20x2,25 pressfitting	1	-
359066	Ø 20x2,5 pressfitting	1	-
359087	Ø 26x3 pressfitting	1	-

Specifications

Manifolds 359 series are used to control and distribute the medium in domestic water circuits. They are supplied already assembled in a plastic inspection box to facilitate positioning and installation. The manifolds are equipped with shut-off valves with handwheels for each individual circuit, and labels summarising the utilities served.



359

tech. broch. 01371

Recessed door with push-to-open frame.

Code

359700



1 -



359

tech. broch. 01371

Aesthetic cover plate made of paintable plastic with a RAL 9010 white finish. Complete with support plate.

Code

359801



1 -



359

tech. broch. 01371

Aesthetic cover plate, in stainless steel. Complete with support plate.

Code

359802 polished finish  
359803 brushed finish



1 -  
1 -

Application diagram

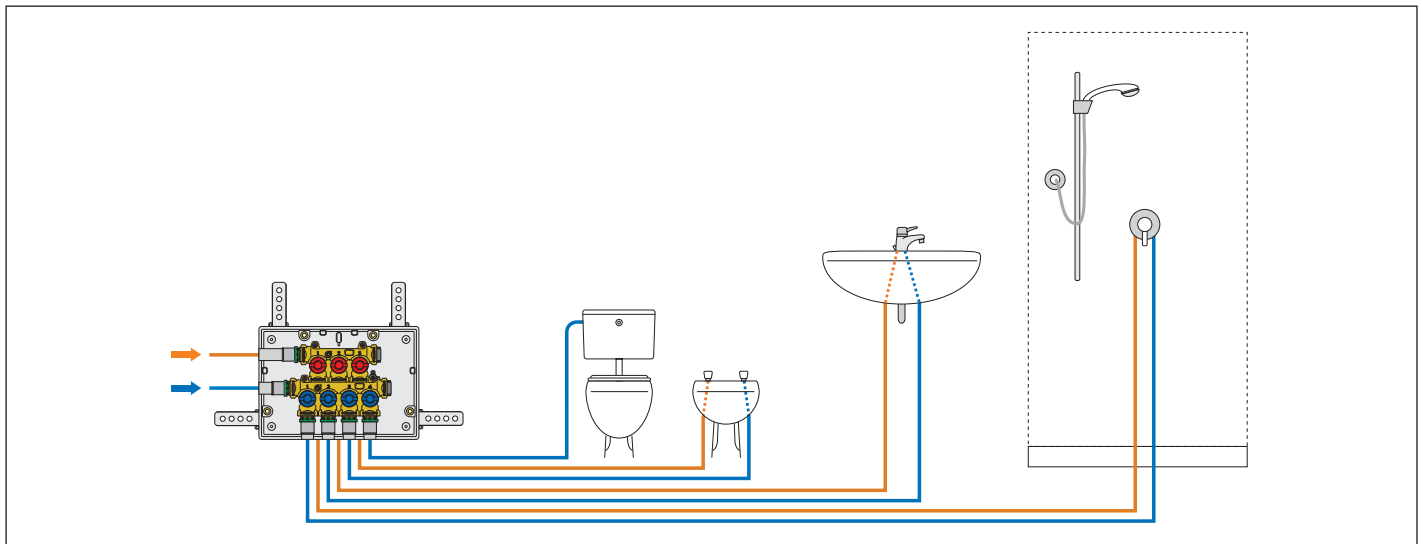

ACCESSORIES FOR MODULAR MANIFOLDS



**359** tech. broch. 01371  
 Manifold with individual shut-off valves (red knobs).  
 Can be used as spare parts.

Code	Outlets No.		
359330*	3	1	-
359340*	4	1	-



**359** tech. broch. 01371  
 Manifold with individual shut-off valves (blue knobs).  
 Can be used as spare parts.

Code	Outlets No.		
359240*	4	1	-
359250*	5	1	-



**359** tech. broch. 01371  
 Brackets with screws for hot water manifold.  
 Stainless steel body.

Code		
359015	1	-



**359** tech. broch. 01371  
 Brackets with screws for cold water manifold.  
 Stainless steel body.

Code		
359016	1	-



**359** tech. broch. 01371  
 Long adapter with clip.  
 Brass body.

Code		
359017*	1	-



**359** tech. broch. 01371  
 Short adapter with clip.  
 Brass body.

Code		
359018*	1	-

\* **CR** dezincification resistant alloy body "LOW LEAD" available on request with the code extension: 001.



Characteristic components

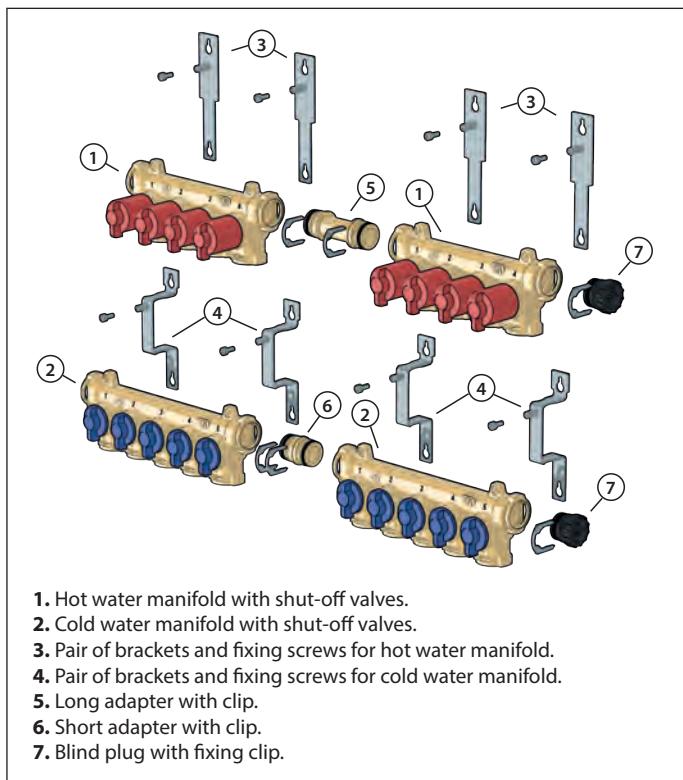

Possible modular manifold configuration

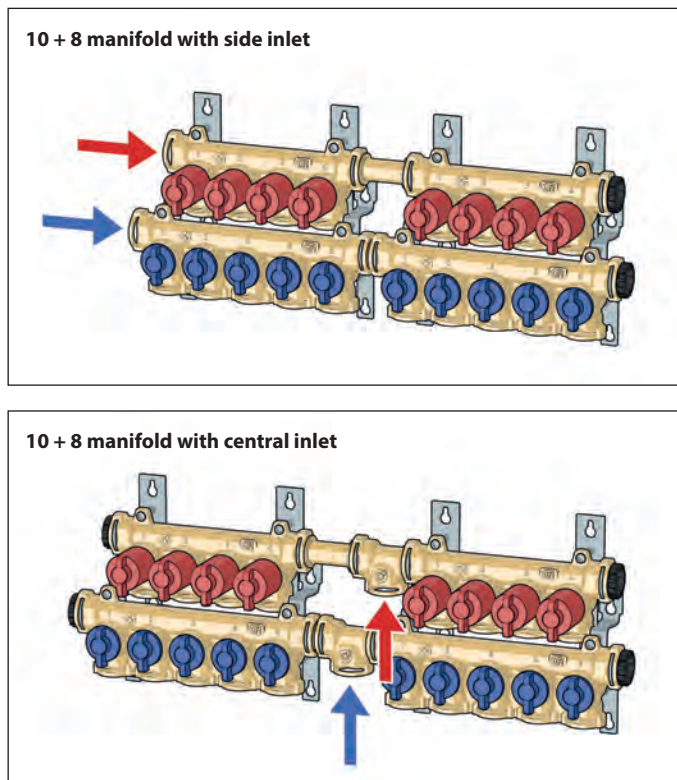

DISTRIBUTION MANIFOLDS WITH MAIN SHUT-OFF VALVES



359

tech. broch. 01371

Domestic water distribution manifolds pre-assembled in boxes with **main shut-off valves**.

Brass body.  
Max. working pressure: 10 bar.  
Temperature range: 5–90 °C.  
Outlet centre distance: 32 mm.

Consisting of:

- pair of manifolds;
- box for manifolds (270 x 190 x 80 mm) complete with manifold supports and fixing brackets;
- cover;
- 4 plugs with fixing clip.

PATENT PENDING.

Code	Outlets No.		Green Box	Brown Box
	cold	hot		
359420*	4	3	1	-

\* CR dezincification resistant alloy body "LOW LEAD" available on request with the code extension: 001.



359

tech. broch. 01371

Accessories for manifolds series 359.

Code	Description	Green Box	Brown Box
359001*	tee with fixing clip	1	-
359002	blind plug with fixing clip	1	-
359024	∅ 16x2 pressfitting	1	-
359064	∅ 20x2 pressfitting	1	-
359025	∅ 16x2,25 pressfitting	1	-
359065	∅ 20x2,25 pressfitting	1	-
359066	∅ 20x2,5 pressfitting	1	-
359087	∅ 26x3 pressfitting	1	-

Possible manifold configurations

Installation with side inlet and recirculation circuit at the bottom.  
Tee for additional outlet and through outlet.

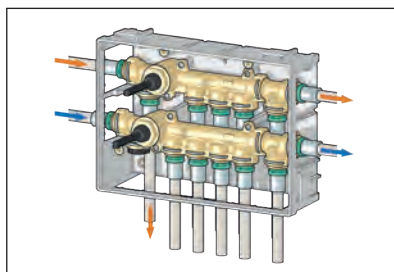

Installation with inlet at the bottom and recirculation at the side.  
Tee for additional outlet and through outlet.

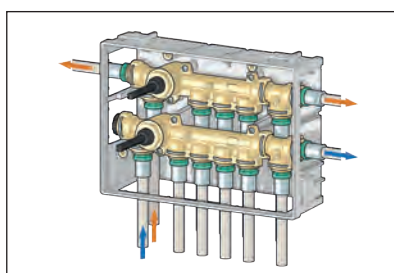

Specifications

Manifolds 359 series are used to control and distribute the medium in domestic water circuits. They are supplied already assembled in a plastic inspection box to facilitate positioning and installation. The manifolds have main shut-off valves on the hot and cold inlets.



359

tech. broch. 01371

Plate with hidden knobs.  
High chrome finish.

Code	Green Box	Brown Box
359902	1	-

Push-to-open knobs

The push-to-open system allows the knob to be hidden, so that the look of the room is not compromised.

Just press it to extract it and open or close the shut-off valves.



Main shut-off cartridge

The special cartridge designed to shut off the 359 series manifold has a double sealing gasket to provide high long-term operating reliability. The materials used in its construction offer a low opening/closing torque and significantly reduce jamming problems due to limescale.

When required, the cartridge can be replaced simply by extracting it from the front of the manifold and inserting the replacement one.

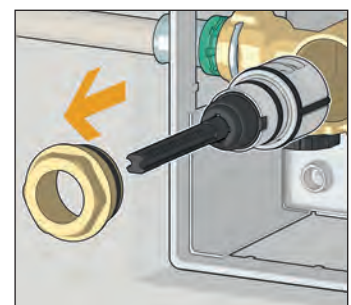

INSPECTABLE DISTRIBUTION MANIFOLDS WITH MAIN SHUT-OFF VALVES



**359** *tech. broch. 01371*  
 Domestic water distribution manifolds pre-assembled in boxes with **main shut-off valves, inspectable**. Brass body.  
 Max. working pressure: 10 bar.  
 Temperature range: 5–90 °C.  
 Outlet centre distance: 32 mm.

- Consisting of:
- pair of manifolds;
  - box for manifolds (270 x 190 x 80 mm) complete with manifold supports and fixing brackets;
  - cover;
  - 4 plugs with fixing clip.

PATENT PENDING.

Code	Outlets No.		Green Box	Brown Box
	cold	hot		
<b>359490*</b>	4	3	1	-

\* **CR** dezincification resistant alloy body "LOW LEAD"  available on request with the code extension: 001.

**359** *tech. broch. 01371*  
 Accessories for manifolds series 359.

Code	Description	Green Box	Brown Box
<b>359001*</b>	tee with fixing clip	1	-
<b>359002</b>	blind plug with fixing clip	1	-
<b>359003</b>	23 p.1,5 fitting with fixing clip	1	-
<b>359004</b>	1/2" fitting Ø 13 flat seat with fixing clip	1	-
<b>359005</b>	3/4" fitting Ø 18 flat seat with fixing clip	1	-
<b>359006</b>	3/4" fitting Ø 18 Euroconus with fixing clip	1	-
<b>359024</b>	Ø 16x2 pressfitting	1	-
<b>359064</b>	Ø 20x2 pressfitting	1	-
<b>359025</b>	Ø 16x2,25 pressfitting	1	-
<b>359065</b>	Ø 20x2,25 pressfitting	1	-
<b>359066</b>	Ø 20x2,5 pressfitting	1	-
<b>359087</b>	Ø 26x3 pressfitting	1	-

Application diagram

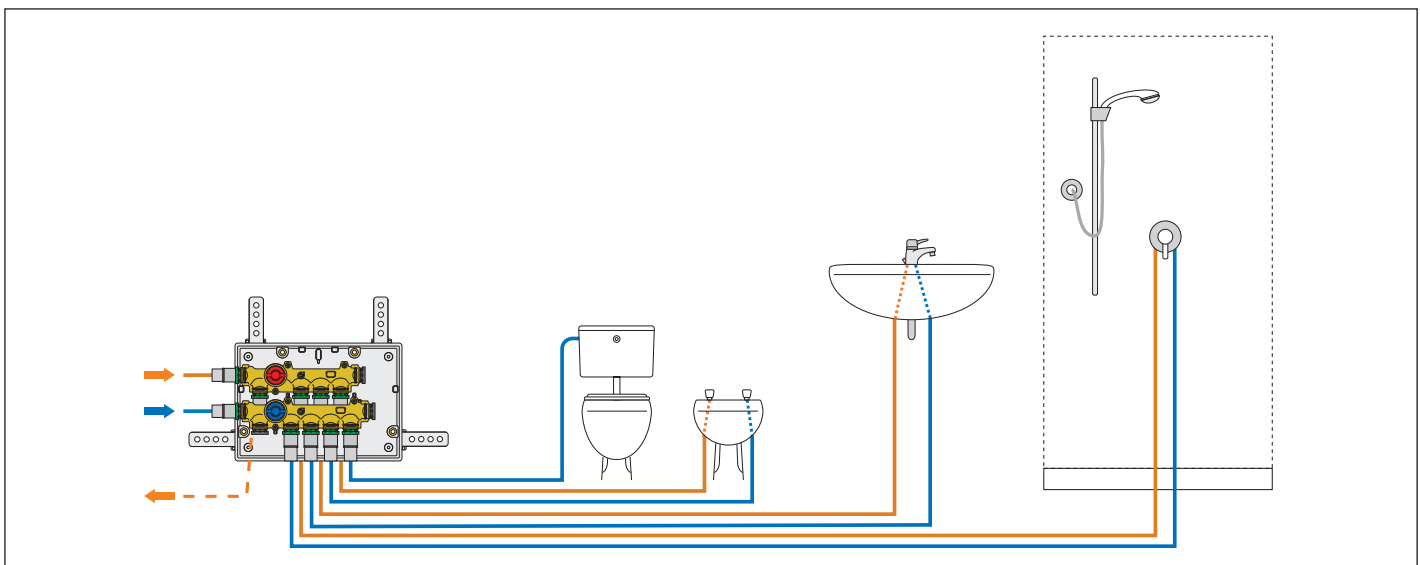

**359** *tech. broch. 01371*  
 Aesthetic cover plate made of paintable plastic with a RAL 9010 white finish. Complete with support plate.

Code	Green Box	Brown Box
<b>359801</b>	1	-



**359** *tech. broch. 01371*  
 Aesthetic cover plate, in stainless steel. Complete with support plate.

Code	Finish	Green Box	Brown Box
<b>359802</b>	polished finish	1	-
<b>359803</b>	brushed finish	1	-

Inspectability

The inspectable box allows full access to the distribution manifold. When the cover plate is removed, it is possible to adjust the shut-off knobs or to intervene for any maintenance operations required. Both compression and press-fittings can be used thanks to this feature.

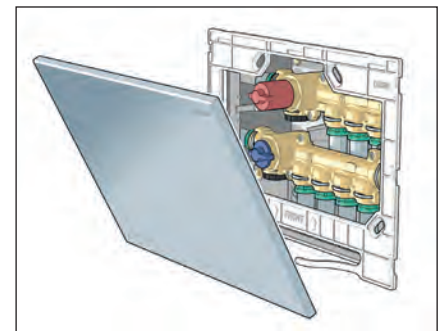

UNIT WITH MAIN SHUT-OFF VALVES



359

tech. broch. 01371

Unit with **main shut-off valves**.  
Brass body.  
Max. working pressure: 10 bar.  
Temperature range: 5–90 °C.

Consisting of:  
- valves unit;  
- box for manifolds (190 x 190 x 80 mm)  
complete with manifold supports  
and fixing brackets;  
- cover;  
- 4 plugs with fixing clip.  
PATENT PENDING

Code

359100\*

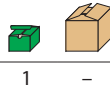

1

-

\* CR dezincification resistant alloy body "LOW LEAD" available on request with the code extension: 001.



359

tech. broch. 01371

Accessories for manifolds 359 series.

Code

359001*	tee with fixing clip	1	-
359002	blind plug with fixing clip	1	-
359024	Ø 16x2 pressfitting	1	-
359064	Ø 20x2 pressfitting	1	-
359025	Ø 16x2,25 pressfitting	1	-
359065	Ø 20x2,25 pressfitting	1	-
359066	Ø 20x2,5 pressfitting	1	-
359087	Ø 26x3 pressfitting	1	-



Specifications

The 359 series units with main shut-off valves are used to control and shut off the medium in domestic water circuits. They are supplied already assembled in a plastic inspection box to facilitate positioning and installation. The units have main shut-off valves on the inlets.



359

Plate with hidden knobs.  
High chrome finish.

Code

359902



1

-

Possible manifold configurations

Installation with horizontal pipes.

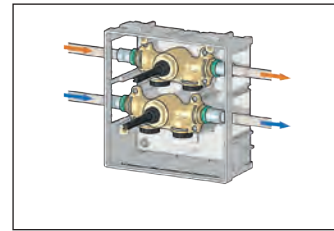

Installation with pipes from below.

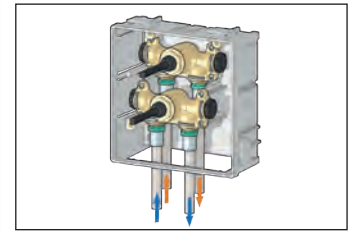

L-shaped installation with recirculation circuit.

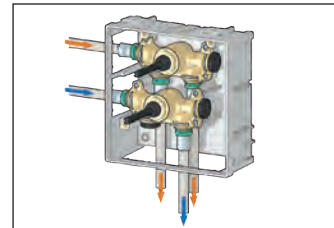

L-shaped installation with hot and cold water recirculation extension tee and through joint.

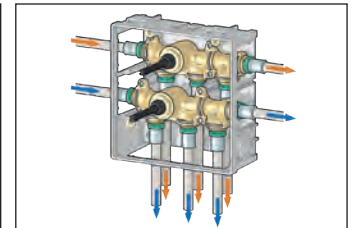

Application diagram

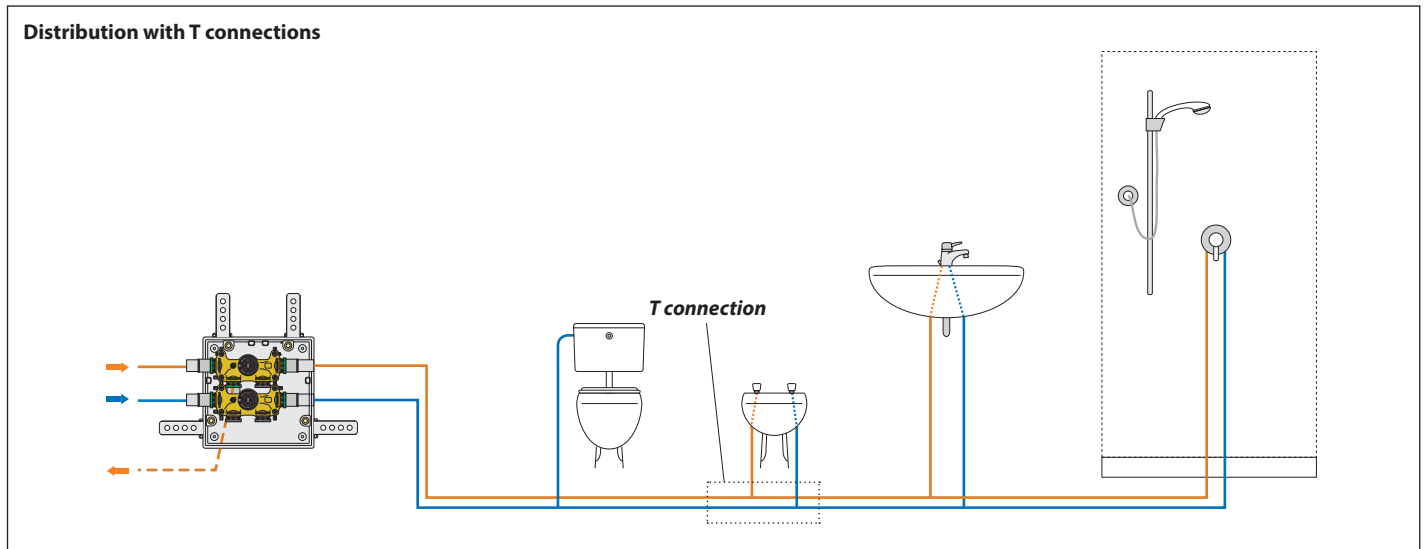

INSPECTABLE UNIT WITH MAIN SHUT-OFF VALVES



**359** *tech. broch. 01371*  
 Unit with **main shut-off valves, inspectable.**  
 Brass body.  
 Max. working pressure: 10 bar.  
 Temperature range: 5–90 °C.  
 Consisting of:  
 - valves unit;  
 - box for manifolds (190 x 190 x 80 mm) complete with manifold supports and fixing brackets;  
 - cover;  
 - 4 plugs with fixing clip.  
 PATENT PENDING

Code	 
<b>359190*</b>	1 -

\* **CR** dezincification resistant alloy body "LOW LEAD" available on request with the code extension: 001.



**Aesthetic cover plate**

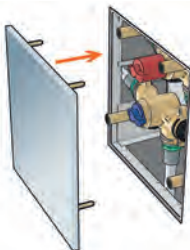

The stainless steel cover plate allows easy inspection of the entire unit.  
 Once removed, it allows access to the opening/closing knobs.  
 It is installed simply by inserting the plate pins into the cylindrical guides for the box.

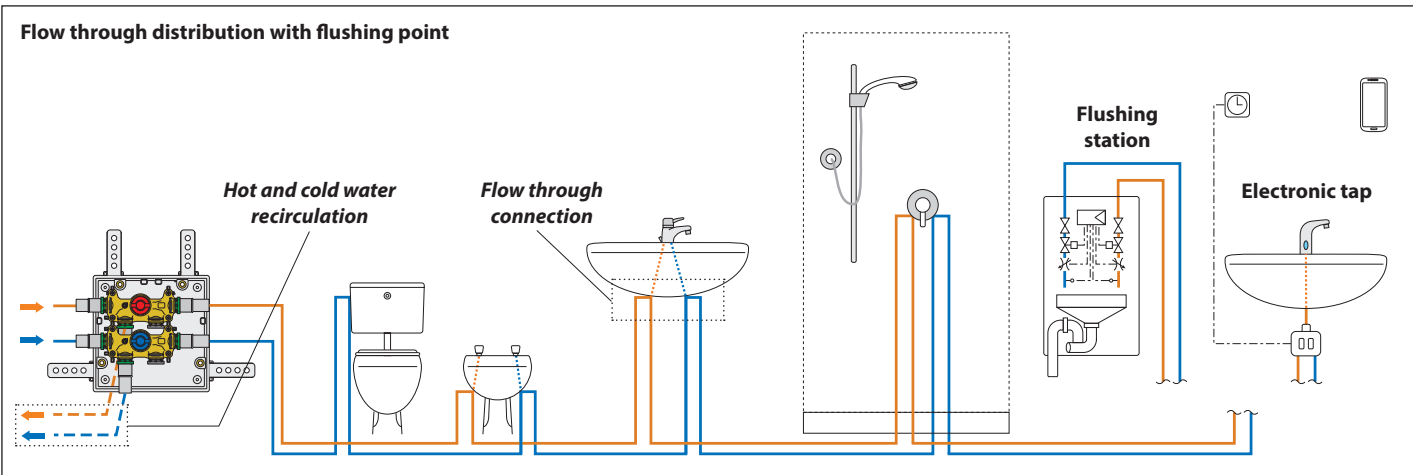
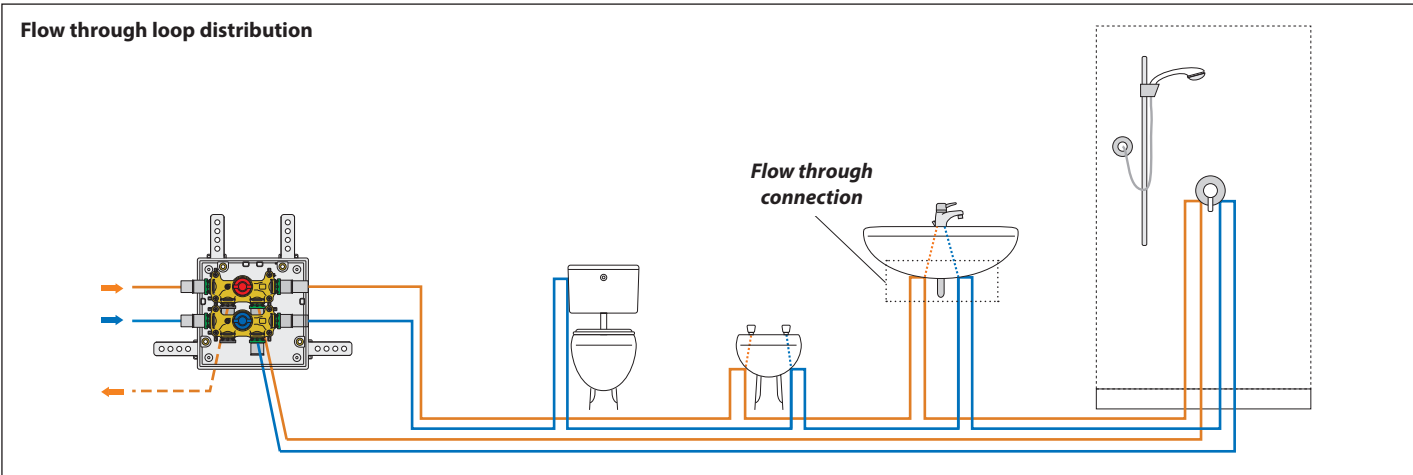

**Application diagrams**



**359** *tech. broch. 01371*  
 Aesthetic cover plate, in stainless steel.

Code	 
<b>359892</b>	polish finish 1 -
<b>359893</b>	brushed finish 1 -

**359** *tech. broch. 01371*  
 Accessories for manifolds series 359.

Code		
<b>359001*</b>	tee with fixing clip	1 -
<b>359002</b>	blind plug with fixing clip	1 -
<b>359003</b>	23 p.1,5 fitting with fixing clip	1 -
<b>359004</b>	1/2" fitting Ø 13 flat seat with fixing clip	1 -
<b>359005</b>	3/4" fitting Ø 18 flat seat with fixing clip	1 -
<b>359006</b>	3/4" fitting Ø 18 Euroconus with fixing clip	1 -
<b>359024</b>	Ø 16x2 pressfitting	1 -
<b>359064</b>	Ø 20x2 pressfitting	1 -
<b>359025</b>	Ø 16x2,25 pressfitting	1 -
<b>359065</b>	Ø 20x2,25 pressfitting	1 -
<b>359066</b>	Ø 20x2,5 pressfitting	1 -
<b>359087</b>	Ø 26x3 pressfitting	1 -

PRESS FITTING FOR MANIFOLDS 359 SERIES



359

Multi-crimp tool pressfittings for multilayer pipes with fixing clips.  
**CR** dezincification resistant alloy body  
**"LOW LEAD"**.  
 Max. working pressure: 10 bar.  
 Temperature range: 5-90 °C.

Can be used with H - TH - U profile crimp tool.



Code



359024	Ø 16x2 pressfitting	1	-
359025	Ø 16x2,25 pressfitting	1	-
359064	Ø 20x2 pressfitting	1	-
359065	Ø 20x2,25 pressfitting	1	-
359066	Ø 20x2,5 pressfitting	1	-
359087*	Ø 26x3 pressfitting	1	-

\* Can be used only with H - TH profile crimp tool.



679

Calibrator and handle to adjust multilayer pipes diameter before use with fittings 359 series.

Code



679002	calibrator Ø 16x2	1	-
679003	calibrator Ø 16x2,25	1	-
679006	calibrator Ø 20x2	1	-
679007	calibrator Ø 20x2,25	1	-
679008	calibrator Ø 20x2,5	1	-
679010	calibrator Ø 26x3	1	-
679009	handle for calibrator	1	-

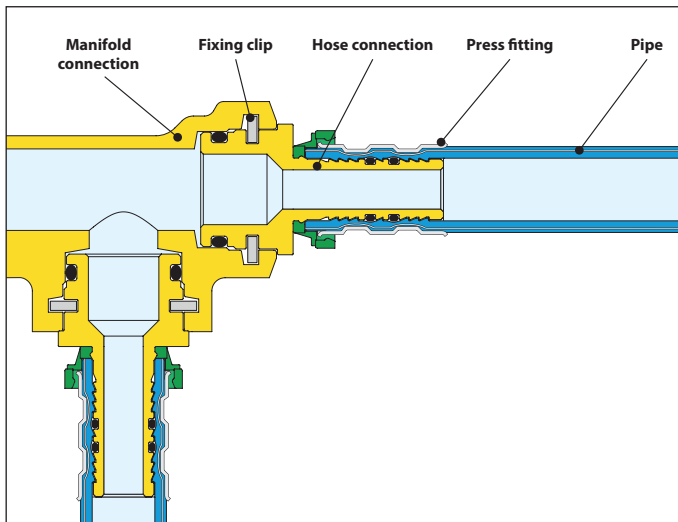

Multilayer pipe calibration and installation of fitting 359 series

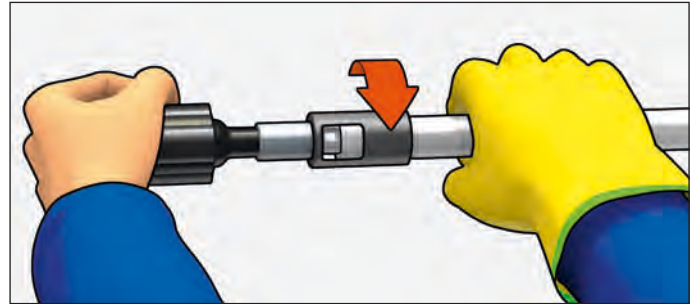

After calibrating the pipe with the calibrator, fit the pipe onto the fitting, taking care to insert it as far as it will go. Check the pipe position through the peepholes.

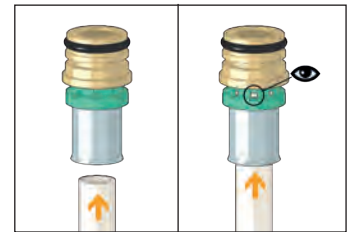

Crimp the pipe with the crimp tool until it clicks automatically.

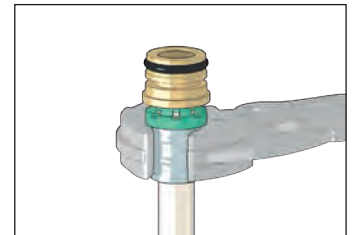

TH profile crimp tool      U profile crimp tool      H profile crimp tool

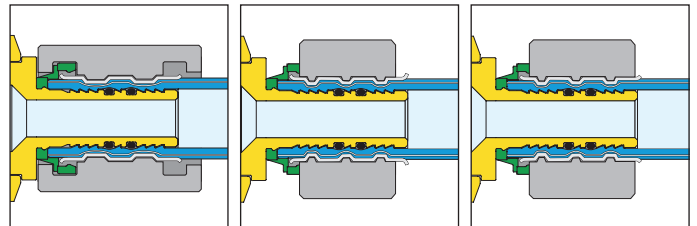

Insert the pipe complete with fitting into the seat on the manifold.

Fasten it with the dedicated fixing clip.

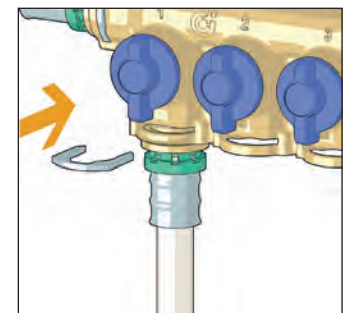
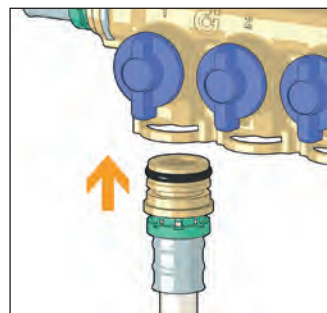



SPARE PARTS FOR MANIFOLDS 359 SERIES



**359**  
Manifold with main shut-off valve.

Code	Outlets No.		
359630*	3	1	-
359640*	4	1	-



**359**  
Fixing clip.

Code		
359007	1	-



**359**  
Inspectable manifold with main shut-off valve (blue knob).

Code	Outlets No.		
359290*	4	1	-



Individual shut-off valves cartridge.

Code		
F0001305	1	-



**359**  
Inspectable manifold with main shut-off valve (red knob).

Code	Outlets No.		
359390*	3	1	-



Main shut-off valves cartridge.

Code		
F0001306	1	-



**359**  
Unit with main shut-off valve.

Code		
359101*	1	-



Main shut-off valves cartridge (inspectable version).

Code		
F0001721	1	-



**359**  
Inspectable unit with main shut-off valve (blue knob).

Code		
359192*	1	-



**359**  
Spare protection cover.

Code		
359010	1	-



**359**  
Inspectable unit with main shut-off valve (red knob).

Code		
359193*	1	-



**359**  
Box bottom.

Code		
359011	1	-
359012	1	-
359013	1	-
359014	1	-

\* CR dezincification resistant alloy body "LOW LEAD" available on request with the code extension: 001.



ACCESSORIES FOR MANIFOLDS 359 SERIES



**359**  
Tee with fixing clip.  
Brass body.  
Max. working pressure: 10 bar.  
Temperature range: 5–90 °C.



\* CR dezincification resistant alloy body "LOW LEAD" available on request with the code extension: 001.

Code	Green Box	Yellow Box
359001*	1	-



**359**  
Blind plug with fixing clip.  
Technopolymer body.

Code	Green Box	Yellow Box
359002	1	-



**359**  
Fitting with fixing clip.  
CR dezincification resistant alloy body "LOW LEAD".  
Max. working pressure: 10 bar.  
Temperature range: 5–90 °C.

Code	Description	Green Box	Yellow Box
359003	23 p. 1,5 fitting with fixing clip	1	-
359004	1/2" fitting Ø 13 flat seat with fixing clip	1	-
359005	3/4" fitting Ø 18 flat seat with fixing clip	1	-
359006	3/4" fitting Ø 18 Euroconus with fixing clip	1	-

PRE-ASSEMBLED DISTRIBUTION MANIFOLDS



**354**  
Modular single distribution manifold with shut-off valve.  
Brass body.  
Max. working pressure: 10 bar.  
Temperature range: 5–100 °C.  
Outlet centre distance: 35 mm.



**Outlet male connections.**  
With flat seat.  
**For press-fittings.**

Code	Connections	Outlets No.	Outlets	Green Box	Yellow Box
354252	3/4"	x 2	1/2" M - Ø 13	2	30
354253	3/4"	x 3	1/2" M - Ø 13	2	20
354254	3/4"	x 4	1/2" M - Ø 13	2	10
354255	3/4"	x 5	1/2" M - Ø 13	2	10



**354**  
Modular single distribution manifold with shut-off valve.  
CR dezincification resistant alloy body.  
Max. working pressure: 10 bar.  
Temperature range: 5–100 °C.  
Outlet centre distance: 35 mm.



Code	Connections	Outlets No.	Outlets	Green Box	Yellow Box
354052	3/4"	x 2	23 p.1,5 M	5	20
354053	3/4"	x 3	23 p.1,5 M	5	20
354054	3/4"	x 4	23 p.1,5 M	5	20
354055	3/4"	x 5	23 p.1,5 M	5	20



**360**  
Pair of stainless steel mounting brackets for manifolds 354 series.  
For inspection box 360 and 362 series.

Code	Green Box	Yellow Box
360210	1	10



**3642**  
End fitting.  
For distribution manifolds 360 series.

Code	Description	Green Box	Yellow Box
364254	3/4" M x 1/2" F	2	-



**3641**  
Plug.  
For distribution manifolds 360 series.

Code	Description	Green Box	Yellow Box
364150	3/4" M	2	-



**5991**  
End fitting.  
For distribution manifolds 360 series.

Code	Description	Green Box	Yellow Box
599154	3/4" F x 1/2" F	2	-



**5993**  
Plug.  
For distribution manifolds 360 series.

Code	Description	Green Box	Yellow Box
599350	3/4" F	2	10

# COMPONENTS FOR DOMESTIC WATER SYSTEMS

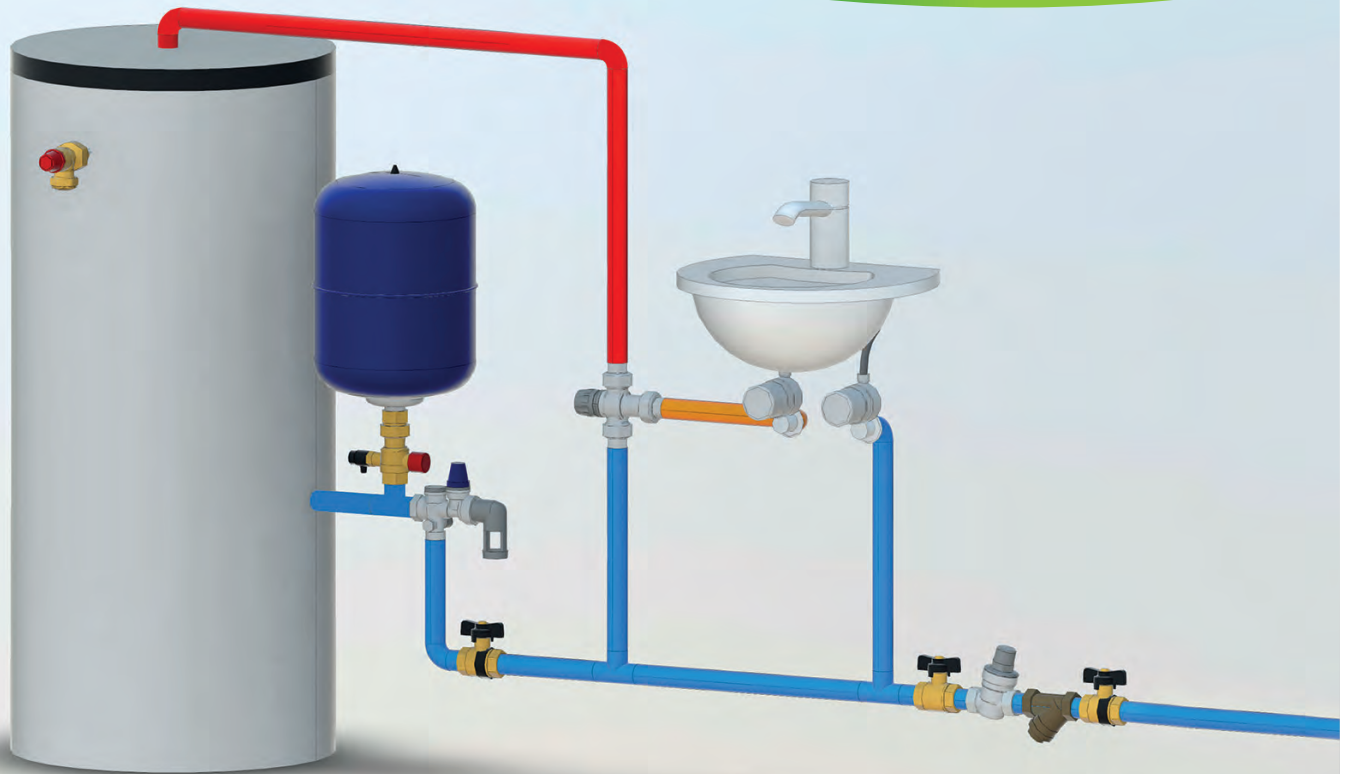

*Diagrams made with BIM families: [bim.caleffi.com](http://bim.caleffi.com)*

**Expansion groups for hot water storage heaters**  
**Hydraulic safety groups for hot water storage heaters**  
**Safety group for hot water storage heaters**  
**Expansion vessels**  
**Water hammer arresters**  
**Temperature and pressure relief valves - flow limiter**  
**Housing and strainer cartridges**  
**Ball valve with built-in check valve**  
**Single and double check valves**  
**Antifreeze safety device**

EXPANSION GROUPS FOR HOT WATER STORAGE HEATERS

528

Expansion group for hot water storage heaters, for horizontal or vertical installation. Brass body and expansion relief valve. With shut-off valve and controllable check valve. Max. working pressure: 10 bar. Max. working temperature: 40 °C. Settings: 7, 8, 10 bar. **Certified to EN 1488.**



Code	Expansion relief valve			
528518	Ø 15	8 bar	1	20
528547	1/2"	7 bar	1	20
528548	1/2"	8 bar	1	20
528540	1/2"	10 bar	1	20

Application diagram 528 series

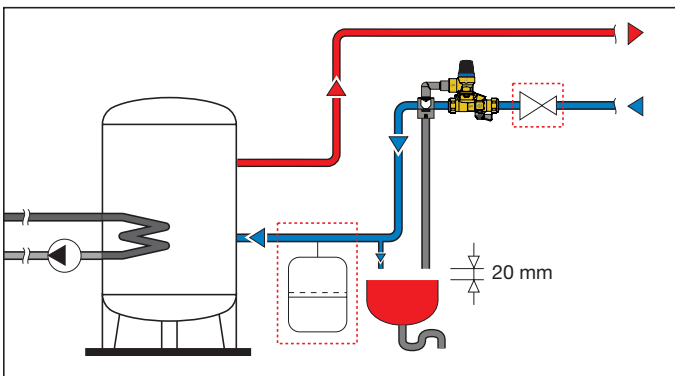
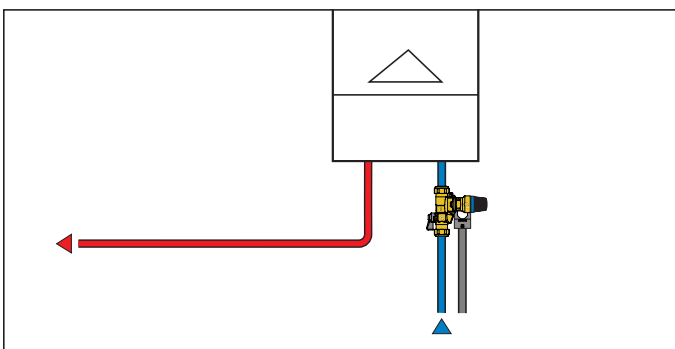
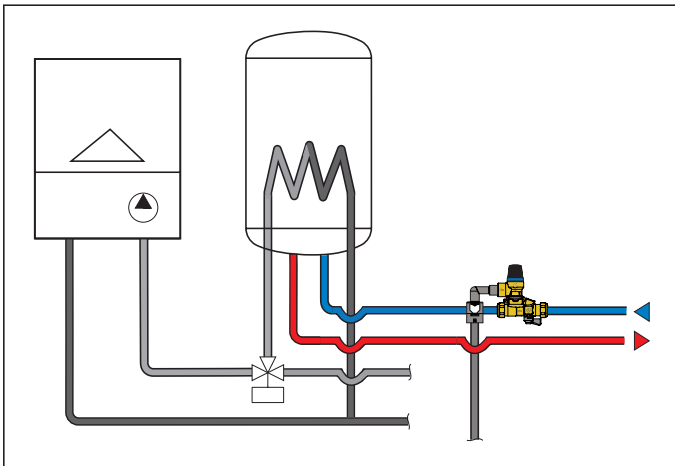

5280 SICAL®

Expansion group for hot water storage heaters, for horizontal or vertical installation. Brass body and expansion relief valve. With shut-off cock and controllable check valve. With insulation. Max. working pressure: 10 bar. Max. working temperature: 40 °C. Max. volume of domestic water storage: 200 l. Max. power of domestic water storage: 75 kW. Settings: 6, 8, 10 bar. **Certified to EN 1488.**

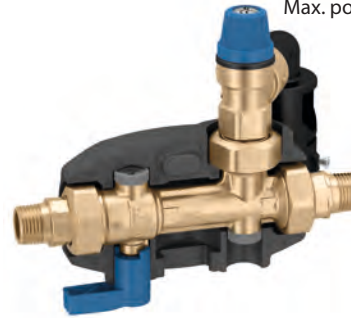

Code	Expansion relief valve		
528046	1/2" M	6 bar	1 5
528048	1/2" M	8 bar	1 5
528041	1/2" M	10 bar	1 5
528056	3/4" M	6 bar	1 5
528058	3/4" M	8 bar	1 5
528051	3/4" M	10 bar	1 5

5281 SICAL®

Expansion group for hot water storage heaters, for horizontal or vertical installation. Brass body and expansion relief valve. With shut-off cock and controllable check valve. With insulation. Max. working pressure: 10 bar. Max. working temperature: 40 °C. Max. volume of domestic water storage: 1000 l. Max. power of domestic water storage: 150 kW. Settings: 6, 8, 10 bar. **Certified to EN 1488.**



Code	Expansion relief valve		
528156	3/4" M	6 bar	1 5
528158	3/4" M	8 bar	1 5
528151	3/4" M	10 bar	1 5
528166	1" M	6 bar	1 5
528168	1" M	8 bar	1 5
528161	1" M	10 bar	1 5

HYDRAULIC SAFETY GROUPS FOR HOT WATER STORAGE HEATERS



5261

tech. broch. 01019

Hydraulic safety group for hot water storage heaters, with shut-off valve and controllable check valve. Brass body. Chrome plated. Max. working pressure: 10 bar. Max. working temperature: 120 °C. Setting: 7 bar. Max. power rating: 1/2" - 4 kW, 3/4" - 10 kW. Certified to EN 1487.



Blue cap-with stainless steel seat.

Code			
526142	1/2"	1	30
526152	3/4"	1	30

Red cap-standard seat

Code			
526140	1/2"	1	30
526150	3/4"	1	30



319

tech. broch. 01019

Plastic discharge tundish for safety groups 5261 series.



Code			
319601	1"	1	25

Application diagram of safety group 5261 series

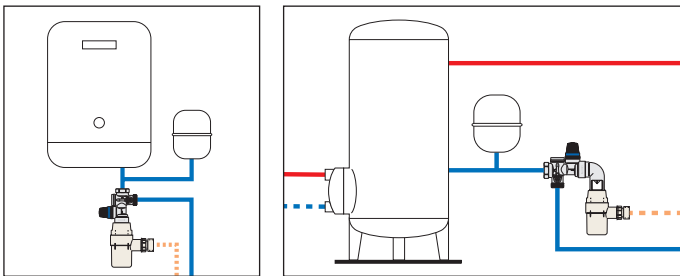

5261

tech. broch. 01019

Hydraulic safety group for hot water storage heaters, with shut-off valve and controllable check valve. For horizontal installation. Brass body. Chrome plated. Max. working pressure: 10 bar. Max. working temperature: 120 °C. Setting: 7 bar. Max. power rating: 3/4" - 10 kW, 1" - 18 kW. Certified to EN 1487.



Blue cap-with stainless steel seat.

Code			
526153	3/4"	1	10
526163*	1" yellow brass body	1	10

\*Without HY mark.

Red cap-standard seat

Code			
526151	3/4"	1	10



6509

Connection kit for unit code 526163.

Code			
650972	1 1/4" F x 1" M	1	25

Application diagram of kit code 650972 with unit code 526163

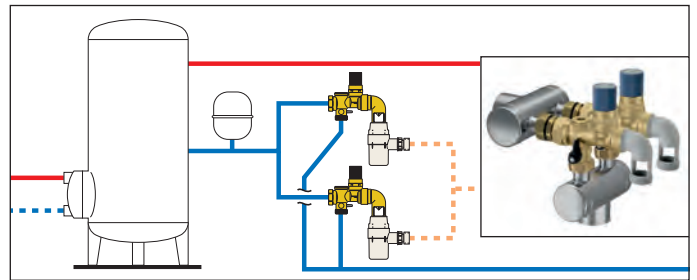

SAFETY GROUP FOR HOT WATER STORAGE HEATERS



5265

Safety group for hot water storage heaters, with shut-off valve and check valve. Brass safety group body. PPSU safety relief valve body. Max. working pressure: 10 bar. Max. working temperature: 120 °C. Safety relief valve opening pressure: 7 bar. Max. power rating: 10 kW. Certified to EN 1487.



Code			
526554	DN 20 (3/4")	1	30

Application diagram safety group 5265 series

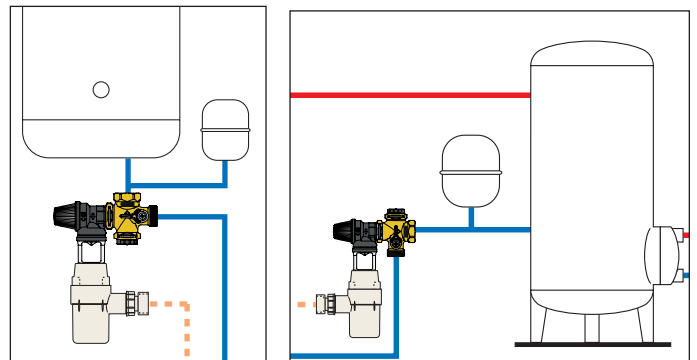

TEMPERATURE AND PRESSURE RELIEF VALVES



309

tech. broch. 01130

Temperature and pressure relief valve.  
**CR** dezincification resistant alloy body.  
**For domestic water system, to protect the hot water storage.**

Setting temperature: 90 °C.  
 Discharge rating: 1/2" - 3/4" x Ø 15: 10 kW.  
 3/4" x Ø 22: 25 kW.

Settings: 3 - 4 - 6 - 7 - 10 bar.  
**Settings certified to EN 1490: 4 - 7 - 10 bar.**



Code			Probe length (mm)		
309430	1/2" M x Ø 15	3 bar	100	1	20
309440	1/2" M x Ø 15	4 bar	100	1	20
309460	1/2" M x Ø 15	6 bar	100	1	20
309470	1/2" M x Ø 15	7 bar	100	1	20
309400	1/2" M x Ø 15	10 bar	100	1	20
309542	3/4" M x Ø 15	4 bar	100	1	20
309530	3/4" M x Ø 22	3 bar	100	1	20
309560	3/4" M x Ø 22	6 bar	100	1	20
309570	3/4" M x Ø 22	7 bar	100	1	20
309500	3/4" M x Ø 22	10 bar	100	1	20
309435	1/2" M x Ø 15	3 bar	200	1	20
309445	1/2" M x Ø 15	4 bar	200	1	20
309465	1/2" M x Ø 15	6 bar	200	1	20
309475	1/2" M x Ø 15	7 bar	200	1	20
309405	1/2" M x Ø 15	10 bar	200	1	20
309547	3/4" M x Ø 15	4 bar	200	1	20
309535	3/4" M x Ø 22	3 bar	200	1	20
309565	3/4" M x Ø 22	6 bar	200	1	20
309575	3/4" M x Ø 22	7 bar	200	1	20
309505	3/4" M x Ø 22	10 bar	200	1	20



309

Temperature and pressure relief valve.  
**CR** dezincification resistant alloy body.  
**For domestic water system, to protect the hot water storage.**

Set temperature: 95 °C.  
 Discharge rating: 25 kW.  
 Setting: 6 bar.

**For systems with nominal pressure of 400 kPa.**



Code			Probe length (mm)		
309563	3/4" M x Ø 22		100	1	20

FLOW LIMITER



534

Flow limiter.  
 Brass body.  
 Chrome plated.  
 1/2" connection.  
 Max. working pressure: 12 bar.  
 Max. working temperature: 80 °C.  
 Pressure range: 1-10 bar.

● Key to code  
 flow direction M ⇒ F = 1  
 flow direction F ⇒ M = 2

Code		Accuracy (%)		
534•02	2 l/min olive green	±30	1	-
534•04	4 l/min grey	±15	1	-
534•05	5 l/min yellow	±15	1	-
534•06	6 l/min black	±10	1	-
534•08	8 l/min white	±10	1	-
534•10	10 l/min light blue	±10	1	-
534•12	12 l/min red	±10	1	-
534•16	16 l/min blue	±10	1	-
534•18	18 l/min purple	±10	1	-

EXPANSION VESSELS



5557

tech. broch. 01079

Welded expansion vessel, for hot water systems, EC certification. Bladder membrane. Max. working pressure: 10 bar. System working temperature range: -10-100 °C. Membrane working temperature range: -10-100 °C. Conformity to EN 13831 standard.



Code	Litres	Conn.	Precharge (bar)		
555702	2	1/2"	2,5	4	-
555705	5	3/4"	2,5	1	-
555708	8	3/4"	2,5	1	-

For bigger capacity see page 296

HOUSING AND STRAINER CARTRIDGES



5370

tech. broch. 01028

Housing for strainer cartridges of standard nominal size 10". Brass body, transparent plastic housing. Max. working pressure: 16 bar. Temperature range: 5-40 °C.

Code			
537050	3/4"	1	-
537060	1"	1	-



5370

tech. broch. 01028

Strainer cartridges for housing 5370 series. Standard nominal size 10". Temperature range: 5-40 °C. Max. Δp: 3 bar. Characteristics: 537004 - nylon washable mesh - 60 μm, 537005 - stainless steel mesh - 50 μm.

Code			
537004		1	-
537005		1	-

WATER HAMMER ARRESTERS



525 ANTISHOCK

tech. broch. 01020

Water hammer arrester. Brass body. Chrome plated. Max. working pressure: 10 bar. Max. working temperature: 90 °C. PTFE seal on thread.



Code			
525040*	1/2"	1	25
525041	1/2" yellow brass body	1	25

\* Certified WRAS only



525 ANTISHOCK

tech. broch. 01020

Water hammer arrester for fitting under sinks, wash-hand basins and washing machine (3/4"). Brass body. Chrome plated. Max. working pressure: 10 bar. Max. working temperature: 90 °C.



Code			
525130*	3/8" F nut x 3/8" M	1	50
525131	3/8" F nut x 3/8" M yellow brass body	1	50
525150*	3/4" F nut x 3/4" M	1	25
525151	3/4" F nut x 3/4" M yellow brass body	1	25

\* Certified WRAS only

Installation diagrams of water hammer arrester 525 series

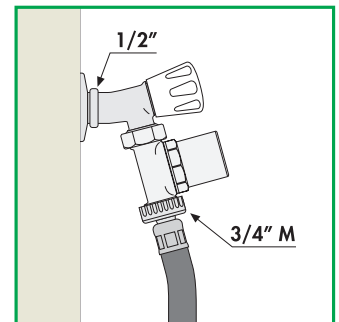
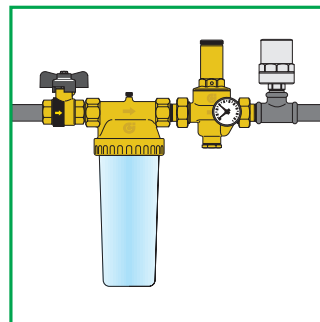
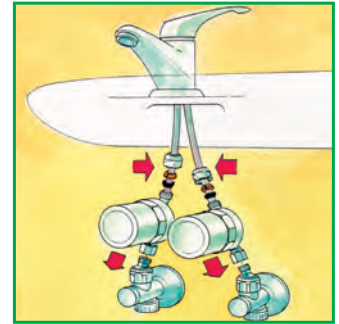
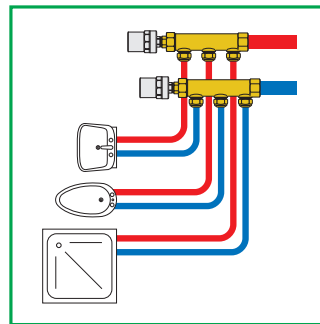

BALL VALVE WITH BUILT-IN CHECK VALVE



**3230 BALLSTOP**

tech. broch. 01021

Ball valve with built-in check valve.  
Brass body.  
Female connections.  
Butterfly handle.  
Max. working pressure: 16 bar.  
Temperature range: 5–90 °C.



Code

<b>323040</b>	1/2"	10	–
<b>323050</b>	3/4"	10	–
<b>323062</b>	1"	10	–



**333 BALLSTOP**

tech. broch. 01021

Ball valve with built-in check valve.  
Brass body.  
Female - nut connection.  
Drilled tamper-proof safety nut.  
Butterfly handle.  
Max. working pressure: 16 bar.  
Temperature range: 5–90 °C.



Code

<b>333400</b>	1/2" F x nut 3/4" F	10	–
<b>333500</b>	3/4" F x nut 3/4" F	10	–



**3230 BALLSTOP**

tech. broch. 01021

Ball valve with built-in check valve.  
Brass body.  
Female connections.  
Lever handle.  
Max. working pressure: 16 bar.  
Temperature range: 5–90 °C.



Code

<b>323060</b>	1"	4	–
<b>323070</b>	1 1/4"	4	–
<b>323080</b>	1 1/2"	2	–
<b>323090</b>	2"	1	–



**334 BALLSTOP**

tech. broch. 01021

Ball valve with built-in check valve.  
Brass body.  
Male - nut connection.  
Drilled tamper-proof safety nut.  
Butterfly handle.  
Max. working pressure: 16 bar.  
Temperature range: 5–90 °C.



Code

<b>334400</b>	1/2" M x nut 3/4" F	10	–
<b>334500</b>	3/4" M x nut 3/4" F	10	–



**332 BALLSTOP**

tech. broch. 01021

Ball valve with built-in check valve.  
Brass body.  
Male - female connections.  
Butterfly handle.  
Max. working pressure: 16 bar.  
Temperature range: 5–90 °C.



Code

<b>332400</b>	1/2" M x 1/2" F	10	–
---------------	-----------------	----	---

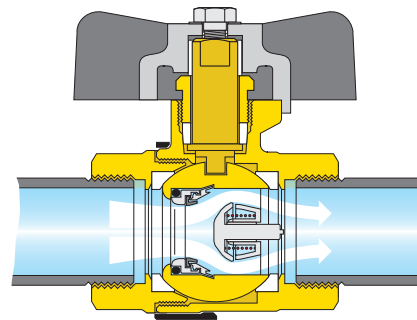

**BALLSTOP**  
TWO VALVES  
IN ONE

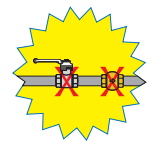

SINGLE AND DOUBLE CHECK VALVES



**3037 ROBOCHECK-1**

15 mm single check valve with compression ends.  
CR dezincification resistant alloy body.  
Chrome plated.  
Max. working pressure: 10 bar.  
Max. working temperature: 90 °C.



Code

<b>303715</b>	Ø 15	10	100
---------------	------	----	-----



**3038 ROBOCHECK-2**

15 mm controllable double check valve with compression ends.  
CR dezincification resistant alloy body.  
Chrome plated.  
Max. working pressure: 10 bar.  
Max. working temperature: 90 °C.



Code

<b>303815</b>	Ø 15	10	100
---------------	------	----	-----



ANTIFREEZE SAFETY DEVICE

603  
ICECAL

tech. broch. 01181



Garden tap, ball type, **with antifreeze safety device.**  
Brass body. Chrome plated.  
Stainless steel lever and fixing nut.  
Hose connection for Ø 15 mm pipe.  
Max. working pressure: 10 bar.  
Ambient temperature range: -30–90 °C.  
Opening temperature: 3 °C.  
Closing temperature: 4 °C.

Code			
<b>603450</b>	1/2" M x 3/4" M with hose connection	1	10

**Function**

The antifreeze safety device prevents ice build-up in domestic water circuits, avoiding possible damage to pipes in hydraulic and irrigation systems. When the minimum intervention temperature is reached, it automatically opens so that a minimum quantity of water may flow toward the drain, enabling a small continuous inflow of water; this prevents the circuit from freezing.

A particular product has been developed by combining the antifreeze safety device with a garden tap ball type, specifically constructed for these installations. The valve is fitted with ball with blow-out proof design, O-ring seal and packing gland; the control lever and fixing nut are made of stainless steel, for total resistance against corrosion in different climatic conditions.

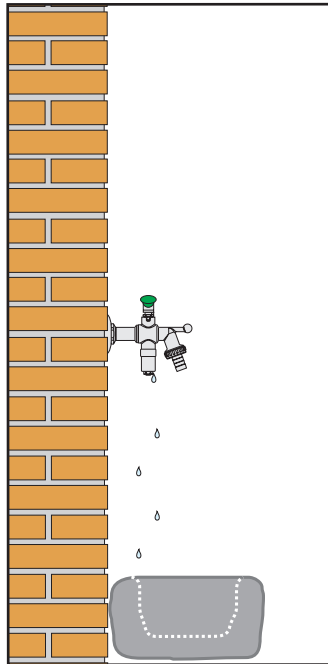

antifreeze group spare part, chrome plated for code 603450.



Code			
<b>F89046/C</b>		1	-

**antifreeze safety device replacement**

The antifreeze safety device is preassembled and can be replaced in case of necessity. A specific internal valve automatically shuts the water off during the replacement operation.

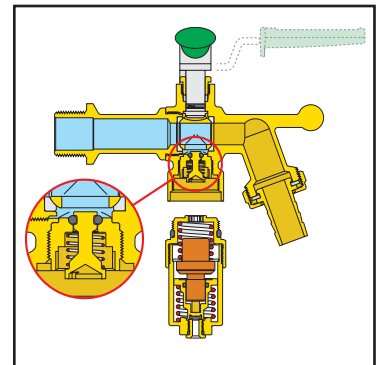

**antifreeze safety device closed**

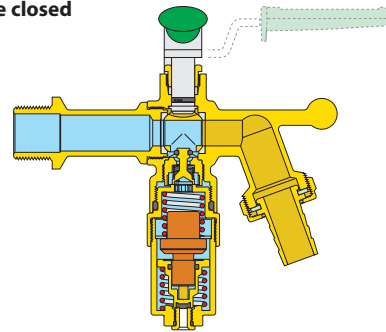

**antifreeze safety device open**

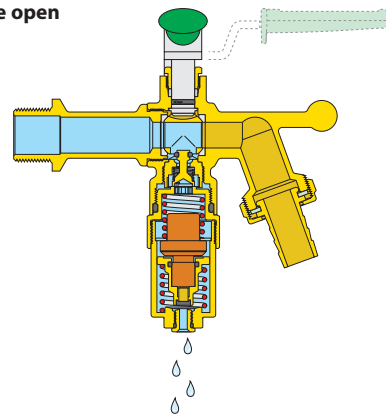

VACUUM BREAKER DEVICE FOR DOMESTIC WATER SYSTEMS



3040

tech. broch. 01402

Vacuum breaker device for domestic water systems. For the protection of hot and cold water storage tanks.

CR dezincification resistant alloy body "LOW LEAD".

Max. working pressure: 14 bar.

Max. working temperature: 120 °C.



Code

304040 1/2" M

304050 3/4" M



1

50

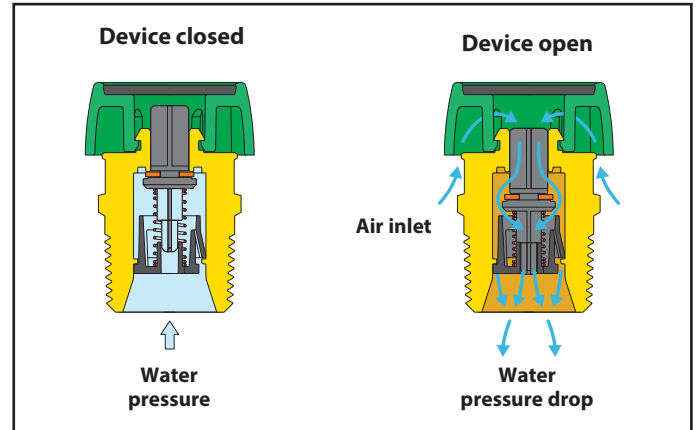

Function

The vacuum breaker device is used to prevent water storages from being damaged by a sudden rapid drop in the pressure of the water inside the tank body. This may happen, for example, if the inlet shut-off valve is left closed and enough water is drawn at the same time to create a significant drop in pressure inside the tank. In this case, the internal pressure loss can lead to the destructive implosion of the tank walls.

The vacuum breaker device should be installed at the top of the tank connection pipe.

When water is being supplied under the correct pressure conditions, the vacuum breaker device remains closed, allowing normal system operation to take place. It opens in pressure loss conditions, allowing the entry of air at atmospheric pressure in order to prevent hazardous situations from arising.

Application diagram, 3040 series

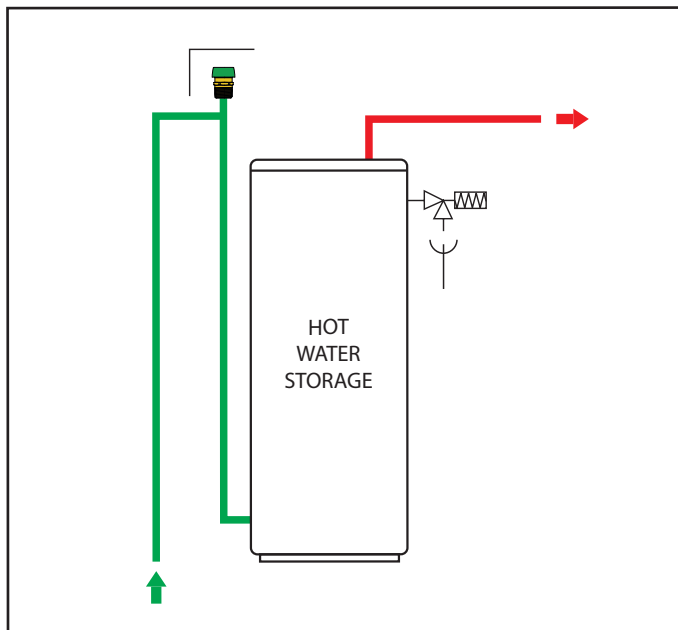

Application diagram, 3040 series

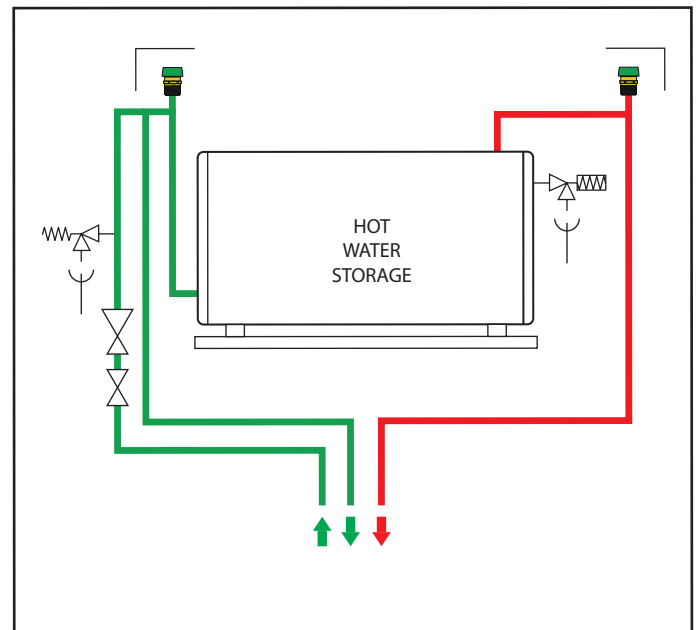

## BACKFLOW PREVENTION DEVICES

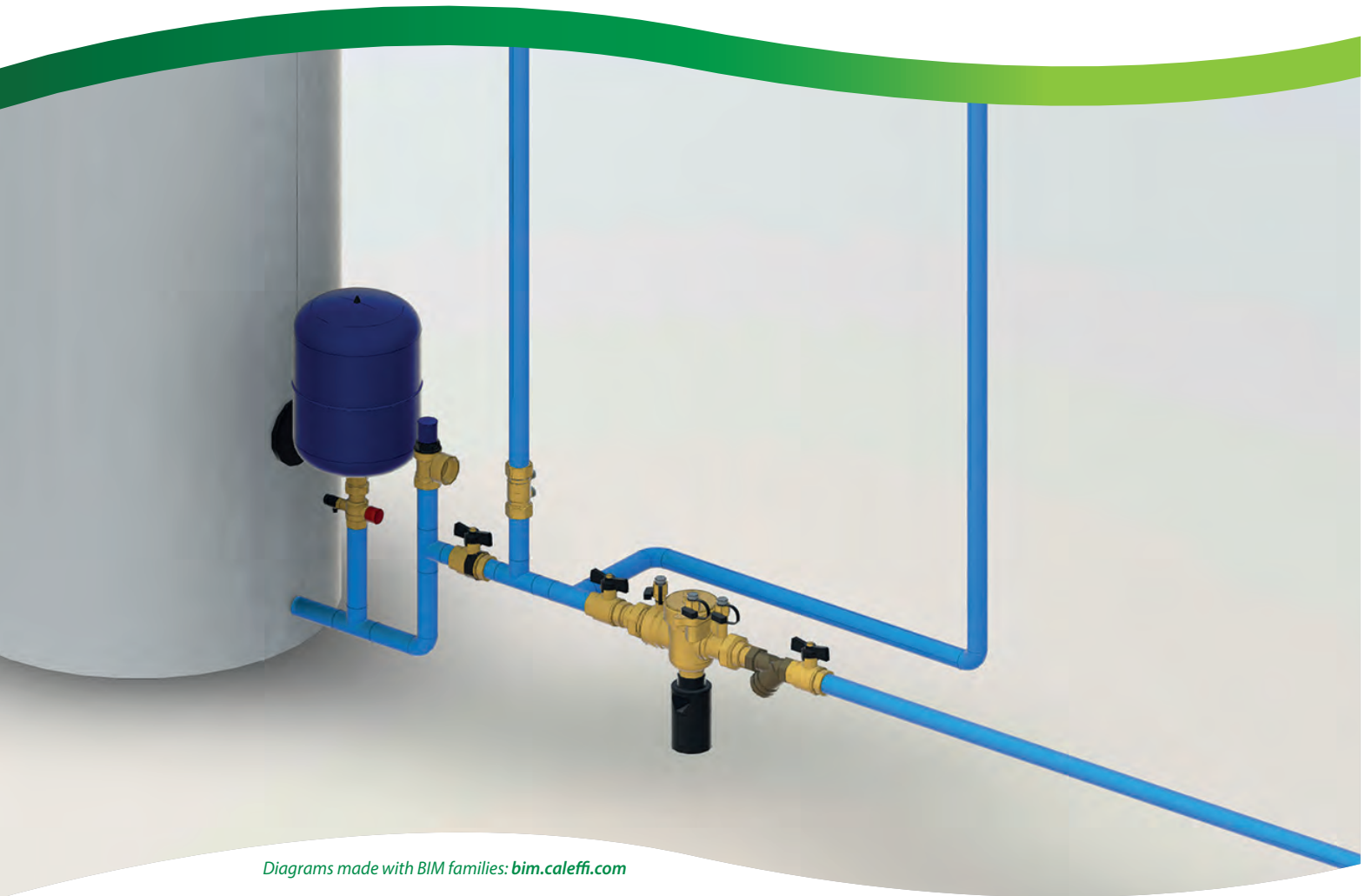

*Diagrams made with BIM families: [bim.caleffi.com](http://bim.caleffi.com)*

### **Backflow preventers**

**Pre-assembled group with backflow preventer, Y-strainers and shut-off valves**

**Y-strainers for backflow preventers**

**Spare parts for backflow preventers**

**Backflow preventers with multifunction geometry**

**Ball valves with built-in check valves, BALLSTOP**

**Anti-pollution check valves**

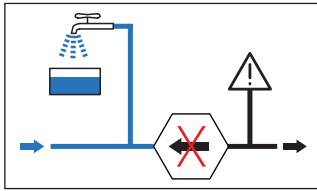

The following pages are extracted from the specific Monographic Guide, which concerns the problem of pollution of water supplies from backflow and presents the range of Caleffi products specifically designed to prevent this problem. The materials of the components and their performance characteristics meet the specific regulatory and safety requirements of water supply systems.



## POLLUTION OF WATER SUPPLIES - NORMATIVE REFERENCES

Pollution is defined as any relative degradation of the quality of potable water.

European standard **EN 1717:2000** "Protection against pollution of potable water in water installations and general requirements of devices to prevent pollution by backflow" is the reference point as regards the prevention of pollution of public water supplies caused the backflow of fluid from private systems downstream.

The above standard is applied in conjunction with **EN 806:2012** "Specifications for installations inside buildings conveying water for human consumption." that indicates the requirements for design, operation and maintenance.

Both these European reference standards should be applied in conjunction with the applicable national standards and regulations. Installations must be designed and maintained in such a way that they do not cause pollution of the public water supply or of the internal system by backflow of any type of substance considered hazardous.

The sequence of appliances, including protection device, filters, check valves, shut-off valves, pressure test ports, air gaps, etc. that together comprise the backflow protection, is defined as the **Protection Unit**.

The Protection Point is defined as the point in the system in which the Protection Unit is applied.

The generic symbol used in EN 1717 to identify the Protection Unit is a hexagon containing the letters indicating the protection Family and Type, as shown in the following figure:



Here below are some examples of Protection Units with the relative sequences of devices required by EN 1717.

Protection unit: Family B, Type A

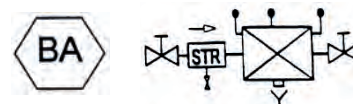

Protection unit: Family C, Type Aa

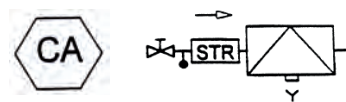

Protection unit: Family E, Type A

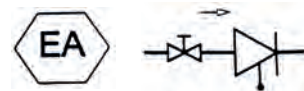

**The standard EN 1717** classifies fluids contained in installations into five categories according to the degree of risk they pose to human health; these categories range from 1, with no human health hazard, to 5, the most hazardous.

**Category 1:**  
Water to be used for human consumption coming directly from a potable water distribution system.

**Category 2:**  
Fluid presenting no human health hazard, as per 1, the quality of which can have undergone a change in taste, odour, colour or temperature.

**Category 3:**  
Fluid representing some human health hazard due to the presence of one or more harmful substances.

**Category 4:**  
Fluid presenting a human health hazard due to the presence of one or more "toxic" or "very toxic" substances or one or more radioactive, mutagenic or carcinogenic substances.

**Category 5:**  
Fluid presenting a human health hazard due to the presence of micro-biological or viral elements.

According to this classification, suitable backflow prevention devices must be fitted in water distribution circuits.

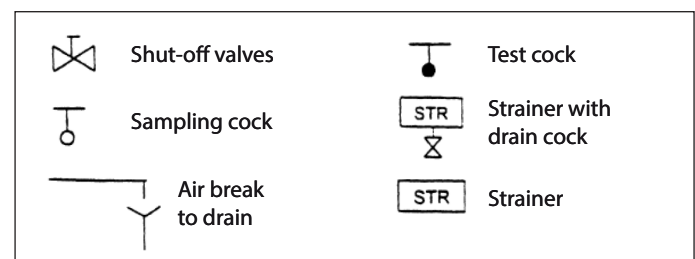

**EN 1717 lists the operating principle and minimum requirements of devices designed to protect the public water supply from the backflow of fluids belonging to one of these five categories.**

Protection devices are grouped in eight Families, identified by the letters A, B, C, D, E, G, H, L, each of which may have one or more variants called Types, also identified with the letters A, B, C, or D. EN 1717 specifies for each Type of device the minimum and maximum fluid category and the conditions in which it may be used for to protect the installation against backflow.

The indications in EN 1717 may be applied to all domestic, industrial/commercial and non domestic installations connected to the public potable water supply:

- domestic installations in residential or similar buildings, such as homes, hotels, schools, offices, hostels, etc.: kitchen sinks, hand basins, baths, showers, WCs, domestic hot water systems, domestic washing machines and dishwashers, garden irrigation systems, systems with low concentrations of additives that are not harmful to human health, such as water treatment, conditioning systems, etc.;
- in industrial and commercial installations the standard applies to all applications of potable water with similar use to a domestic installation, excluding therefore process water; also fire fighting, centralised heating or irrigation systems;
- non domestic installations for professional uses of water, for example, industries, commerce, agriculture, clinics, public and private swimming pools and thermal baths.

**POLLUTION OF WATER SUPPLIES - NORMATIVE REFERENCES**

**Backflow**

Potable water from the mains supply may be subject to pollution caused mainly by the contaminated fluids flowing back from plumbing installations connected directly to the mains supply. Backflow can be attributed to a variation in the pressure difference that causes a consequent inversion of the normal direction of flow at certain point of the installation. This phenomenon, termed "backflow", occurs when:

- a) the pressure in the mains system is less than that in the plumbing circuit receiving the supply (back syphonage). This situation can occur, for example, due to a break in the pipework of the mains supply and the consequent maintenance work, or when significant quantities of water are drawn by other users connected upstream, such as fire-fighting systems.
- b) the pressure in the plumbing circuit receiving the supply rises (back pressure) due, for example, to water being pumped from a well.

**Risk assessment**

Given the potential dangers of the phenomenon and the requirements of current regulations, the risk of pollution caused by backflow must be assessed on the basis of the type of system and the characteristics of the fluid that flows inside it.

A suitable backflow prevention device must be selected on the basis of the assessment performed by the system designer and the mains supplier. The device must be located along the supply line at the points at risk of backflow which would be hazardous to human health.

In addition to consultation of the European standard EN 1717, it is always necessary to consult the water supplier and the specific national regulations as, depending the type of installation, there may be more restrictive or more permissive derogations from the European standard.

In situations where there are fluids present that pose different degrees of hazard, backflow prevention should consider the most hazardous of these fluids. In the case of fluids that are exceptionally hazardous, it will be necessary to assess additional technical parameters.

In the case of applications where it is not possible to verify the risk level, it is necessary to hypothesise the greatest risk. The "Protection Matrix" tables reported in the list Monographic Guide various types of installation and the corresponding fluid categories.

**Protection Unit - Product standards - Caleffi devices**

Tables 1 and 2 below list all the Protection Units defined in EN 1717, with the relative fluid categories, the product standards and the corresponding products in the Caleffi catalogue.

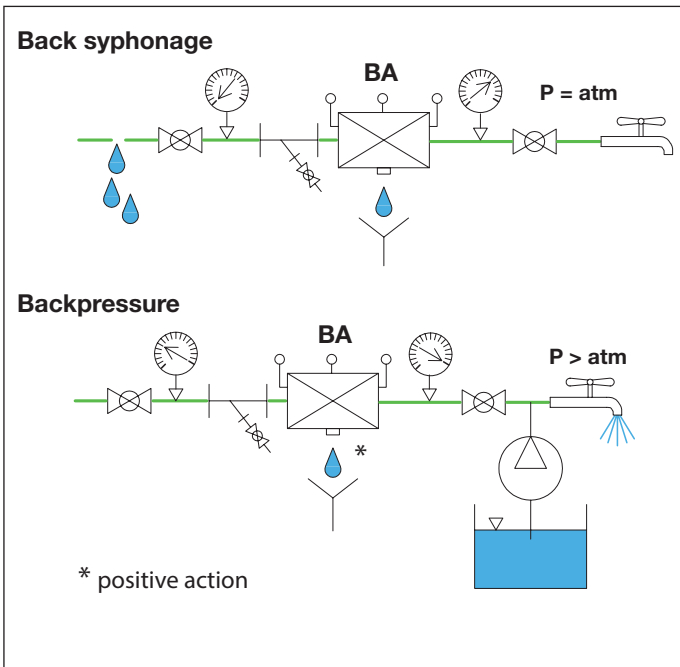

Devices	Category	Authorised level of the Protection Unit
Tap with spray outlet over handbasins, sinks, showers, baths; excluding WCs and bidets	5	Protection unit for category 2 and EB, ED, HC
Tap with water inlet below the rim of the tub (b)	5	Protection unit for category 3
Draw-off tap for hose connection (a b)	5	Protection unit for category 3
Over ground or in-ground irrigation system (b)	5	Protection unit for category 4

(a) Used for washing, cleaning or garden irrigation  
 (b) The Protection Unit must be installed above the maximum operating level

Family Type	EN 1717 Protection unit	Fluid category					Product standard	Caleffi series
		1	2	3	4	5		
BA	Backflow preventer with controllable reduced pressure zone	●	●	●	●	-	EN 12729	580, 574, 575
CA	Backflow preventer with different non controllable pressure zones	●	●	●	-	-	EN 14367	573
EA	Controllable anti-pollution check valves from DN 6 to DN 250	●	●	-	-	-	EN 13959	3045, 3046
EB	Non-controllable anti-pollution check valves from DN 6 to DN 250			■			EN 13959	3047
EC	Controllable anti-pollution double check valves from DN 6 to DN 250	●	●	-	-	-	EN 13959	
ED	Non-controllable anti-pollution double check valves from DN 6 to DN 250			■			EN 13959	

Units with atmospheric vent must not be installed in zones at risk of flooding (for example, AA, BA, CA, GA, GB...)  
 ● Covers the risk    - Does not cover the risk    ■ Only for certain sanitary uses (see Table 2)

BACKFLOW PREVENTERS



572

Non controllable backflow preventer with different pressure zones for wall mounted boilers.  
**CAb type.** Brass body. PN 10.  
 Ø 6 copper pipe connections.  
 Max. working temperature: 40 °C.  
**Certified to standard EN 14367.**



Code		
572106	1	50



573

tech. broch. 01328

Non controllable backflow preventer with different pressure zones. **CAa type.**  
 Brass body. PN 10.  
 Female union connections.  
 Max. working temperature: 65 °C.  
**Certified to standard EN 14367.**



Code		
573415	1/2"	1 10
573515	3/4"	1 10



573

Non controllable backflow preventer with different pressure zones.  
 Normally closed.  
 Brass body. PN 10.  
 Female union connections.  
 With threaded outlet.  
 Max. working temperature: 65 °C.

Code		
573405	1/2"	1 20
573505	3/4"	1 20



574

tech. broch. 01022

Controllable, reduced pressure zone backflow preventer.  
**BA type.**  
 CR dezincification resistant alloy components "LOW LEAD".  
 PN 10. Male union connections.  
 Max. working temperature: 65 °C.  
 Discharge opening differential pressure to: 14 kPa.  
**Certified to standard EN 12729.**



Upstream of the backflow preventer is mandatory to install a strainer 577 series.



Code		
574004	1/2"	1 10



574

tech. broch. 01022

Controllable, reduced pressure zone backflow preventer.  
**BA type.**  
 CR dezincification resistant alloy components "LOW LEAD".  
 PN 10. Male union connections.  
 Max. working temperature: 65 °C.  
 Discharge opening differential pressure to: 14 kPa.  
**Certified to standard EN 12729.**  
**Upstream of the backflow preventer is mandatory to install a strainer 577 series.**



Code		
574040	1/2"	1 -
574050	3/4"	1 -
574006	1"	1 -

BACKFLOW PREVENTERS



574

tech. broch. 01022

Controllable, reduced pressure zone backflow preventer.  
**BA type.**  
 CR dezincification resistant alloy components "LOW LEAD".  
 PN 10. Male union connections.  
 Max. working temperature: 65 °C.  
 Discharge opening differential pressure to: 14 kPa.  
**Certified to standard EN 12729.**  
**Upstream of the backflow preventer is mandatory to install a strainer 577 series.**



Code			
574600	1"	1	-
574700	1 1/4"	1	-
574008	1 1/2"	1	-

575

tech. broch. 01022

Controllable, reduced pressure zone backflow preventer.  
**BA type.** Bronze body. PN 10. Flanged connections PN 16.  
 To be coupled with flat counterflanges EN 1092-1.  
 Max. working temperature: 65 °C.  
 Discharge opening differential pressure to: 14 kPa.  
**Certified to standard EN 12729.**  
**Upstream of the backflow preventer is mandatory to install a strainer 579 series.**



Code			
575005	DN 50	1	-
575006	DN 65	1	-
575008	DN 80	1	-
575010	DN 100	1	-

574

tech. broch. 01022

Controllable, reduced pressure zone backflow preventer.  
**BA type.** Bronze body. PN 10. Male union connections.  
 Max. working temperature: 65 °C.  
 Discharge opening differential pressure to: 14 kPa.  
**Certified to standard EN 12729.**  
**Upstream of the backflow preventer is mandatory to install a strainer 577 series.**

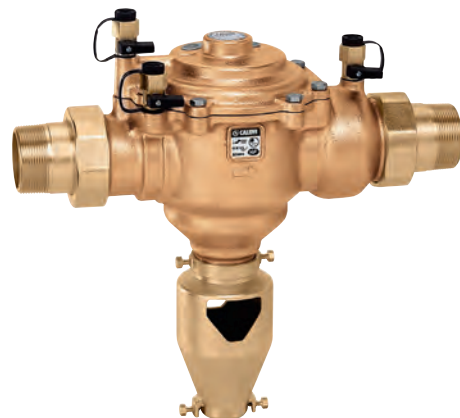

Code			
574800	1 1/2"	1	-
574900	2"	1	-

570

tech. broch. 01022

Pre-assembled group consisting of:  
 backflow preventer 574 series;  
 Y-strainer 577 series for backflow preventers;  
 manual shut-off valves.  
 PN 10. Female connections.  
 Max. working temperature: 65 °C.



Code			
570004	1/2"	1	-
570005	3/4"	1	-
570006	1"	1	-
570007	1 1/4"	1	-
570008	1 1/2"	1	-
570009	2"	1	-



**BACKFLOW PREVENTERS**

**570**

tech. broch. 01022

Pre-assembled group consisting of:  
backflow preventer 575 series;  
Y-strainer 579 series for backflow preventers;  
manual shut-off valves.  
PN 10. Flanged connections PN 16.  
To be coupled with flat counterflanges EN 1092-1.  
Max. working temperature: 65 °C.





Code				
570050	DN 50	1	–	
570060	DN 65	1	–	
570080	DN 80	1	–	
570100	DN 100	1	–	

**575**

tech. broch. 01245

Controllable, reduced pressure zone backflow preventer.  
**BA type.** Cast iron body, with epoxy coating.  
PN 10. Flanged connections.  
To be coupled with flat counterflanges EN 1092-1.  
Max. working temperature: 60 °C.  
Discharge opening differential pressure to: 14 kPa.  
**Certified to standard EN 12729.**  
**Upstream of the backflow preventer is mandatory to install a strainer 579 series.**





Code				
575150	DN 150	1	–	
575200	DN 200	1	–	
575250	DN 250	1	–	

**570**

tech. broch. 01245

Pre-assembled group consisting of:  
backflow preventer 575 series;  
Y-strainer 579 series for backflow preventers;  
manual shut-off valves.  
PN 10. Flanged connections PN 16.  
To be coupled with flat counterflanges EN 1092-1.  
Max. working temperature: 60 °C.





Code				
570150	DN 150	1	–	
570200	DN 200	1	–	
570250	DN 250	1	–	

**Y-STRAINERS AND TEST KIT FOR BACKFLOW PREVENTERS**

**577**

Y-strainer,  
for backflow preventers 573 and 574 series.  
Bronze body,  
1/2"–2": PN 16,  
2 1/2" - 3": PN 10.  
Female connections.  
Temperature range: -20–110 °C.  
Max. percentage of glycol: 30 %.  
Strainer in stainless steel stretched plate.





Code		Mesh size Ø (mm)	Kv (m³/h)		
577004	1/2"	0,40	2,5	1	–
577005	3/4"	0,40	3,9	1	–
577006	1"	0,40	7	1	–
577007	1 1/4"	0,47	16	1	–
577008	1 1/2"	0,47	24	1	–
577009	2"	0,53	35	1	–
577020	2 1/2"	0,53	57	1	–
577030	3"	0,53	73	1	–

**579**

Y-strainer, for backflow preventer 575 series  
and for pressure reducing valve 576 series.  
Cast iron body, with epoxy coating.  
Flanged connections PN 16.  
To be coupled with flat counterflanges  
EN 1092-1.  
Max. working pressure: 16 bar.  
Max. working temperature: 65 °C.  
Stainless steel mesh.  
With drain cock.



Code		Mesh size Ø (mm)	Kv (m³/h)		
579050	DN 50	1	28	1	–
579060	DN 65	1	37,2	1	–
579080	DN 80	1	62,2	1	–
579100	DN 100	1,6	149	1	–
579120	DN 125	1,6*	320	1	–
579150	DN 150	1,6*	367	1	–
579200	DN 200	1,6*	652	1	–
579250	DN 250	2*	844	1	–



\* Rhomboidal reinforcing mesh



**SPARE PARTS FOR BACKFLOW PREVENTERS**





Discharge device for backflow preventers 574 and 575 series.

Code			
<b>59978</b>	1/2" (574004)	1	-
<b>59471</b>	1/2" (574040) - 3/4" - 1" (574006)	1	-
<b>59457</b>	1" (574600) - 1 1/4" - 1 1/2" (574008)	1	-
<b>59461</b>	1 1/2" - 2" - DN 50	1	-





Discharge device for backflow preventer 575 series.

Code			
<b>59625</b>	DN 65 (575006)	1	-
<b>59629</b>	DN 80 (575008) - DN 100 (575010)	1	-





Discharge valve seat for backflow preventers 574 and 575 series.

Code			
<b>59472</b>	1/2" (574040) - 3/4" - 1" (574006)	1	-
<b>59458</b>	1" (574600) - 1 1/4" - 1 1/2" (574008)	1	-
<b>59462</b>	1 1/2" - 2" - DN 50 - DN 65	1	-





Discharge valve seat for backflow preventer 575 series.

Code			
<b>59630</b>	DN 80 (575008) - DN 100 (575010)	1	-



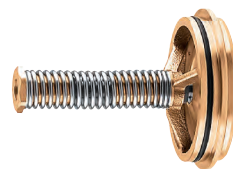

Upstream check valve for backflow preventers 574 and 575 series.

Code			
<b>59977</b>	1/2" (574004)	1	-
<b>59973</b>	1/2" (574040) - 3/4" (574050)	1	-
<b>59469</b>	3/4" (574005) - 1" (574006)	1	-
<b>59455</b>	1" (574600) - 1 1/4" - 1 1/2" (574008)	1	-
<b>59459</b>	1 1/2" - 2" - DN 50	1	-





Upstream check valve for backflow preventer 575 series.

Code			
<b>59627</b>	DN 65 (575006)	1	-
<b>59631</b>	DN 80 (575008) - DN 100 (575010)	1	-



Downstream check valve for backflow preventers 574 and 575 series.

Code			
<b>59979</b>	1/2" (574004)		
<b>59470</b>	1/2" (574040) - 3/4" - 1" (574006)	1	-
<b>59456</b>	1" (574600) - 1 1/4"	1	-
<b>F0001636</b>	1 1/2" (574008)	1	-
<b>59460</b>	1 1/2" - 2" - DN 50	1	-



Downstream check valve for backflow preventer 575 series.

Code			
<b>59628</b>	DN 65 (575006)	1	-
<b>59632</b>	DN 80 (575008) - DN 100 (575010)	1	-

BACKFLOW PREVENTERS WITH MULTIFUNCTION GEOMETRY



580

tech. broch. 01322

Backflow preventer with multifunction geometry. **BA type.** CR dezincification resistant alloy body. Threaded union connections. For linear installation on horizontal or vertical pipes. Complete with strainer at the inlet. Max. working pressure: 10 bar. Max. working temperature: 65 °C. **Certified to EN 12729 standard.**



Code

580004	DN 15	1/2" M	1	5
580040	DN 15 (Cartridge DN 20)	1/2" M	1	5
580050	DN 20	3/4" M	1	5
580060	DN 25	1" M	1	-
580070	DN 32	1 1/4" M	1	-

Discharge tundish

Thanks to the possibility of orienting the tundish, the same body can be used in three different configurations: installation on horizontal or vertical pipes or for special applications.

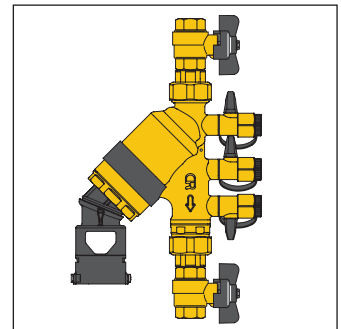
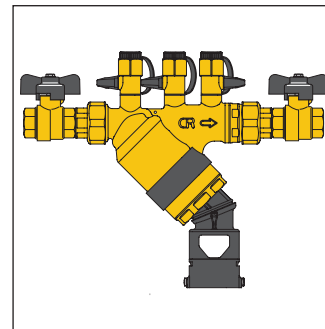

580

tech. broch. 01322



Backflow preventer with multifunction geometry. **BA type.** CR dezincification resistant alloy body. Complete with connection fitting to the tap at the inlet and hose connection at the outlet. For vertical installation. Complete with strainer at the inlet. Max. working pressure: 10 bar. Max. working temperature: 65 °C. **Certified to EN 12729 and Beschluss 4/2007 standard.**



Code

580104	DN 15	3/4" nut x 3/4" M	1	5
580150	DN 20	3/4" nut x 3/4" M	1	5

Self-contained cartridge

The self-contained cartridge comprises, all in one piece, the membrane, the upstream check valve, the discharge valve and the whole activation system. In case of maintenance, it can be easily extracted from the body without the aid of further sealing elements.



580

tech. broch. 01322



Backflow preventer with multifunction geometry. **BA type.** CR dezincification resistant alloy body. Complete with isolating valve at the inlet and hose connection at the outlet. For vertical installation. Complete with strainer at the inlet. Max. working pressure: 10 bar. Max. working temperature: 65 °C. **Certified to EN 12729 and W570-3 standard.**



Code

580240	DN 15 (Cartridge DN 20)	1/2" M x 3/4" M	1	5
580250	DN 20	3/4" M x 3/4" M	1	5

Application diagram code 580104/580150

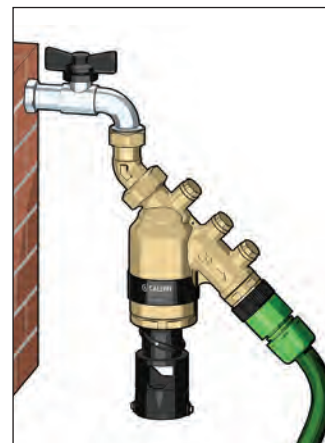

Application diagram code 580240/580250

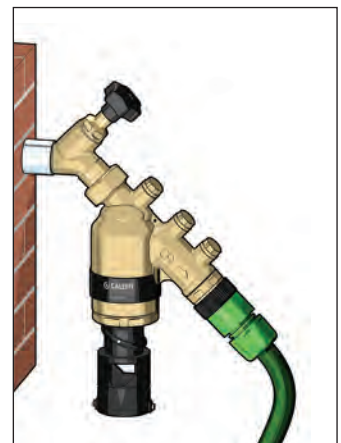

ANTI-POLLUTION CHECK VALVES WITH BUILT-IN SHUT-OFF VALVE



324

tech. broch. 01341

Anti-pollution check valve with built-in shut-off valve. **EA type.** Pressure test ports upstream and downstream. Replaceable check valve cartridge. **CR** dezincification resistant alloy body **"LOW LEAD"**. Medium: drinking water. Max. working pressure: 10 bar. Check valve minimum opening pressure ( $\Delta p$ ): 0,5 kPa. Max. working temperature: 65 °C. **Certified to EN 13959 and EN 13828 standards.** PATENT PENDING.



Code	DN internal check valve	Conn.		
324140	20	1/2" M	1	10
324150	20	3/4" M	1	10

Operating principle

The anti-pollution check valve with built-in shut-off valve is comprised of a valve body (1), a check valve (2), two test ports (3), one downstream for operation checks and one downstream for system pressure testing, a shut-off ball valve (4) with control lever (5). The check valve (2) delimits two distinct zones: one upstream or at the inlet (A), and one downstream or at the outlet (B).

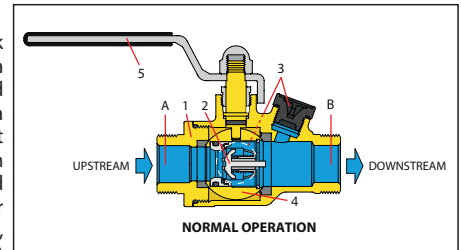

Operation check

To test the seal of the check valve, check that the valve closes each time the pressure in the upstream water supply so as to prevent water from the installation flowing back into the supply system:

- to maintain pressure in the installation in the absence of flow, close all shut-off valves and users downstream of the valve. Using the downstream test port, check that the pressure is greater than 0,5 bar;
- close the built-in shut-off valve, rotating it clockwise through 90° relative to the longitudinal position, and open the check valve test port. The flow should stop after the small amount of fluid contained in the valve body between the shut-off valve and pressure test port has drained off;
- if not, check the seal of the built-in shut-off valve: if this valve is sealing correctly but the flow from the test port continues, replace the check valve, as the flow can only be caused by imperfect sealing of the valve.



324

tech. broch. 01341

Anti-pollution check valve with built-in shut-off valve. **EA type.** Pressure test ports upstream and downstream. Replaceable check valve cartridge. **CR** dezincification resistant alloy body **"LOW LEAD"**. Medium: drinking water. Max. working pressure: 10 bar. Check valve minimum opening pressure ( $\Delta p$ ): 0,5 kPa. Max. working temperature: 65 °C. **Certified to EN 13959 and EN 13828 standards.** PATENT PENDING.



Code	DN internal check valve	Conn.		
324250	20	3/4" M x nut 3/4" F	1	10

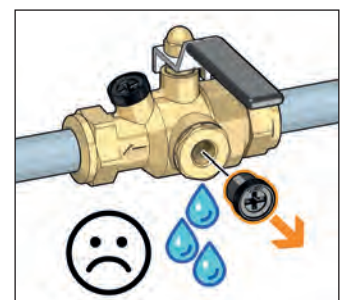
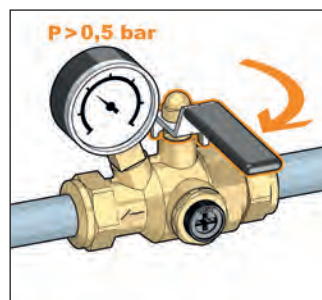

Replacement of the check valve

Thanks to the special patented design, all operation check and replacement operations can be carried out using just one shut-off valve:

- position the lever perpendicular to the valve body by raising it slightly and rotating it anti-clockwise through 90° relative to the longitudinal position;
- open the side cap;
- remove the snap ring;
- use pliers to remove the snap ring, taking care not to damage it. Carry out the maintenance operations, position the original or replacement check valve in its seat and refit by reversing the removal procedure.

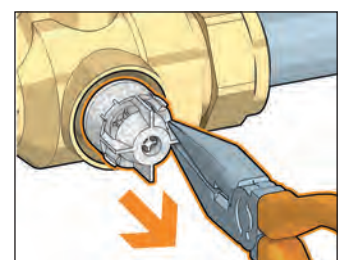
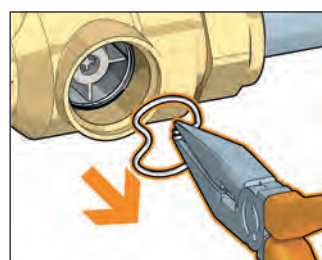
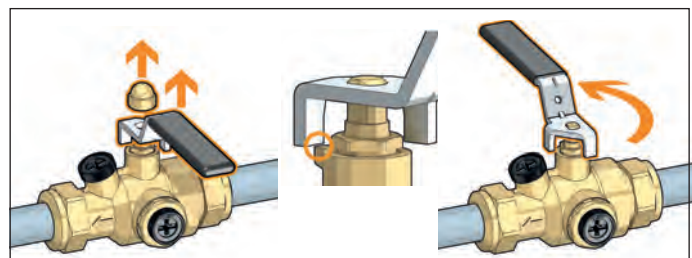

324

tech. broch. 01341

Anti-pollution check valve with built-in shut-off valve. **EA type.** Pressure test ports upstream and downstream. Replaceable check valve cartridge. **CR** dezincification resistant alloy body **"LOW LEAD"**. Medium: drinking water. Max. working pressure: 10 bar. Check valve minimum opening pressure ( $\Delta p$ ): 0,5 kPa. Max. working temperature: 65 °C. **Certified to EN 13959 and EN 13828 standards.** PATENT PENDING.



Code	DN internal check valve	Conn.		
324110	20	Ø 15	1	10
324120	20	Ø 22	1	10

Code			
F0002665	pressure gauge 0-10 bar	1	-

**BALL VALVE WITH BUILT-IN CHECK VALVE**



**3230 BALLSTOP**

tech. broch. 01021

Ball valve with built-in check valve.  
Brass body.  
Female connections.  
Butterfly handle.  
Max. working pressure: 16 bar.  
Temperature range: 5–90 °C.



Code			
323040	1/2"	10	–
323050	3/4"	10	–
323062	1"	10	–



**333 BALLSTOP**

tech. broch. 01021

Ball valve with built-in check valve.  
Brass body.  
Female - nut connection.  
Drilled tamper-proof safety nut.  
Butterfly handle.  
Max. working pressure: 16 bar.  
Temperature range: 5–90 °C.



Code			
333400	1/2" F x nut 3/4" F	10	–
333500	3/4" F x nut 3/4" F	10	–



**3230 BALLSTOP**

tech. broch. 01021

Ball valve with built-in check valve.  
Brass body.  
Female connections.  
Lever handle.  
Max. working pressure: 16 bar.  
Temperature range: 5–90 °C.



Code			
323060	1"	4	–
323070	1 1/4"	4	–
323080	1 1/2"	2	–
323090	2"	1	–



**334 BALLSTOP**

tech. broch. 01021

Ball valve with built-in check valve.  
Brass body.  
Male - nut connection.  
Drilled tamper-proof safety nut.  
Butterfly handle.  
Max. working pressure: 16 bar.  
Temperature range: 5–90 °C.



Code			
334400	1/2" M x nut 3/4" F	10	–
334500	3/4" M x nut 3/4" F	10	–



**332 BALLSTOP**

tech. broch. 01021

Ball valve with built-in check valve.  
Brass body.  
Male - female connections.  
Butterfly handle.  
Max. working pressure: 16 bar.  
Temperature range: 5–90 °C.



Code			
332400	1/2" M x 1/2" F	10	–

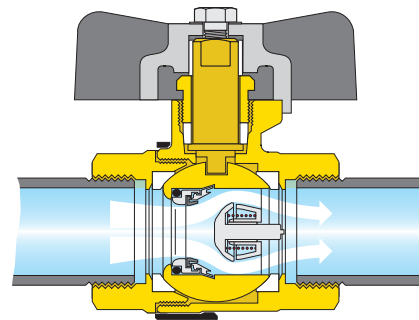

**BALLSTOP**  
TWO VALVES  
IN ONE

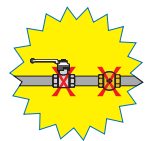

**SINGLE AND DOUBLE CHECK VALVES**



**3037 ROBOCHECK-1**

15 mm single check valve with compression ends.  
CR dezincification resistant alloy body.  
Chrome plated.  
Max. working pressure: 10 bar.  
Max. working temperature: 90 °C.



Code			
303715	Ø 15	10	100



**3038 ROBOCHECK-2**

15 mm controllable double check valve with compression ends.  
CR dezincification resistant alloy body.  
Chrome plated.  
Max. working pressure: 10 bar.  
Max. working temperature: 90 °C.



Code			
303815	Ø 15	10	100

ANTI-POLLUTION CHECK VALVES



**3045** tech. broch. 01005  
 Check valve. **EA type.**  
 Controllable. Brass body.  
 Female connections.  
 Max. working pressure: 10 bar.  
 Max. working temperature: 65 °C.  
**Certified to standard EN 13959.**



Code	Inside check device DN	Connections		
304540	1/2"		10	100
304550	3/4"		10	50
304560	1"		5	25
304570	1 1/4"		5	25
304580	1 1/2"		2	20
304590	2"		1	10



**3046**  
 Check valve. **EA type.**  
 Controllable. Brass body.  
 Nut - male connections.  
 Max. working pressure: 10 bar.  
 Max. working temperature: 65 °C.  
**Certified to standard EN 13959.**



Code	Inside check device DN	Connections		
304645	15	3/4" F x 3/4" M	10	100



**3046**  
**Compact check valve. EA type.**  
 Controllable. Brass body.  
 Nut - male connections.  
 Max. working pressure: 10 bar.  
 Max. working temperature: 65 °C.  
**Certified to standard EN 13959.**



Code	Inside check device DN	Connections		
304601	15	3/4" F x 3/4" M	10	100



**3046** tech. broch. 01005  
 Check valve. **EA type.**  
 Controllable. Brass body.  
 Nut - male connections.  
 Max. working pressure: 10 bar.  
 Max. working temperature: 65 °C.  
**Certified to standard EN 13959.**



Code	Inside check device DN	Connections		
304640	15	3/4" F x 3/4" M	10	100
304650	20	1" F x 1" M	10	50
304660*	25	1 1/4" F x 1 1/4" M	5	25
304670*	32	1 1/2" F x 1 1/2" M	4	20
304680*	40	2" F x 2" M	2	10

\* Without NF and SVGW certification



**3046**  
 Check valve. **EA type.**  
 Controllable. Brass body.  
 Nut - male connections.  
 Max. working pressure: 10 bar.  
 Max. working temperature: 65 °C.  
**Certified to standard EN 13959.**



Code	Inside check device DN	Connections		
304644	15	3/4" F nut x 3/4" M	1	50
304654	20	1" F nut x 1" M	1	50



**3047** tech. broch. 01005  
 Check valve. **EB type.**  
 Non controllable. Brass body.  
 Female connections.  
 Max. working pressure: 10 bar.  
 Max. working temperature: 65 °C.



Code	Connections		
304740	1/2"	10	100
304750	3/4"	10	50
304760	1"	5	25



**3048** tech. broch. 01005  
 Double check valve.  
 Controllable. Brass body.  
 Female connections.  
 Max. working pressure: 10 bar.  
 Max. working temperature: 65 °C.



Code	Connections		
304840	1/2"	1	50
304850	3/4"	1	50

**Double check valve 3048 series**

This double check valve can be used according to local regulations, instead of the backflow preventer when a low pressure valve, at the inlet from the public network, is present. The watertightness of the check valve, furthermore, can be verified by using the pressure test port on the valve body.

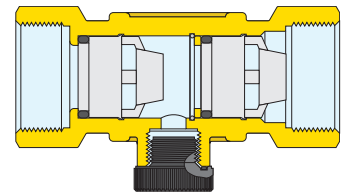

**3041** tech. broch. 01005  
 Ball valve with built-in certified check valve.  
 Controllable. Brass body.  
 Nut - male connections.  
 Max. working pressure: 10 bar.  
 Max. working temperature: 65 °C.



Code	Inside check device DN	Connections		
304140	15	3/4" F x 3/4" M	5	25



## BALANCING AND CONTROL DEVICES

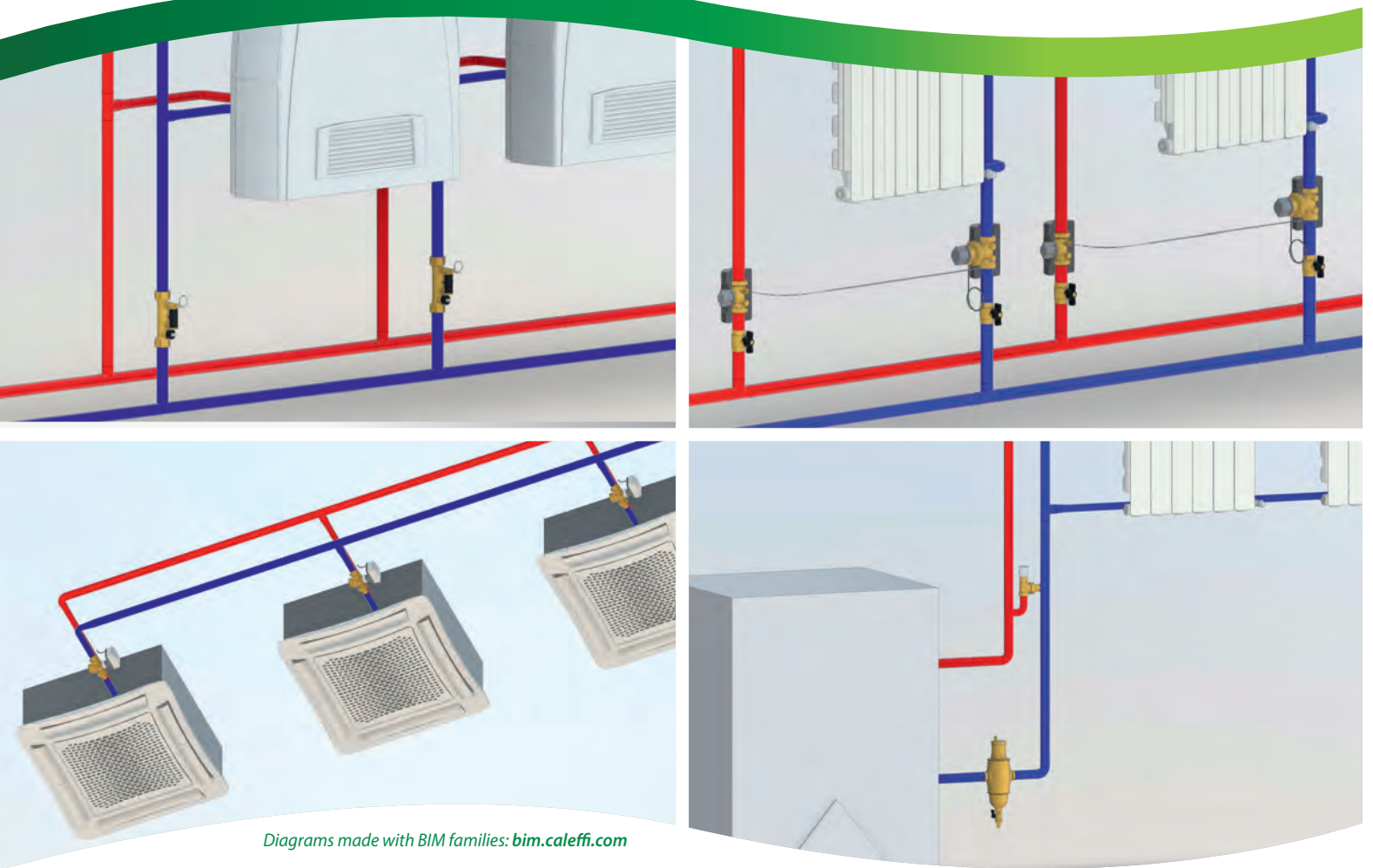

- Static balancing devices**
- Dynamic balancing and control devices**
- Differential pressure control devices**
- Regulating valves**



## BALANCING AND CONTROL DEVICES

Circuit balancing devices can be classified in accordance with their method of action and the type of control they perform in relation to the hydronic circuit.



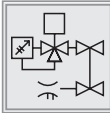
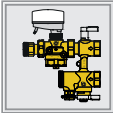
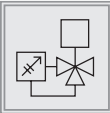
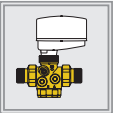

### Static balancing devices

- Manual balancing valve, with Venturi device	130 series		
- Manual balancing valve, with variable orifice	130 series		
- Balancing valve with flow meter	132 series		

### Dynamic balancing and control devices

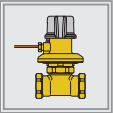
- Connection and regulation kit for HVAC terminal units	149 series		
- Pressure independent control valve (PICV)	145-146 series		
- Automatic flow rate regulator, fixed flow rate	127-128-121-126-120-125-103 series		

### Differential pressure control devices

- Differential pressure control valve	140 series		
- Shut-off and pre-regulation valve	142 series		
- Differential by-pass valve	519 series		

### Regulating valves

- Regulating valves	636 series		
- Temperature regulating valves	610-611-612 series		



## STATIC BALANCING DEVICES

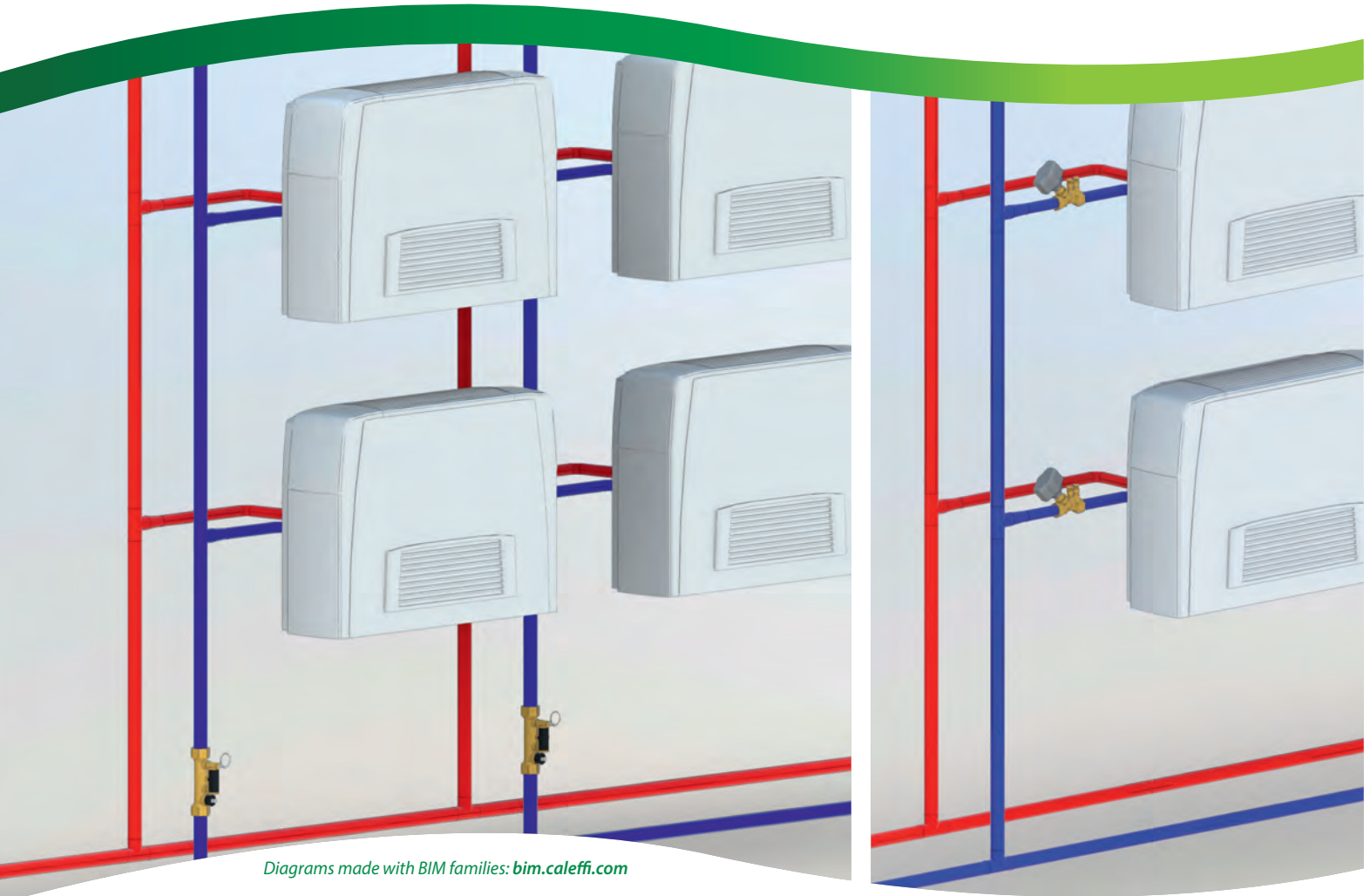

- Manual balancing valve**
- Manual balancing valve, with Venturi device**
- Manual balancing valve, with variable orifice**

BALANCING VALVES

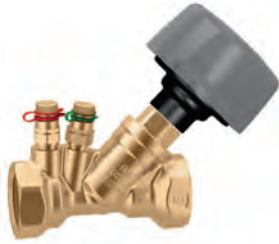

130

tech. broch. 01251

Balancing valve for hydraulic systems. Flow rate measurement with Venturi device. CR dezincification resistant alloy body, stainless steel obturator. Complete with pressure ports. Max. working pressure: 16 bar. Temperature range: -20–120 °C. Max. percentage of glycol: 50 %.



Code			
130400	1/2"	1	5
130500	3/4"	1	5
130600	1"	1	5
130700	1 1/4"	1	5
130800	1 1/2"	1	5
130900	2"	1	5



Pre-formed insulation for balancing valves with threaded connections 130 series. For heating and cooling system.

Code			
CBN130400	1/2"	1	–
CBN130500	3/4"	1	–
CBN130600	1"	1	–
CBN130700	1 1/4"	1	–
CBN130800	1 1/2"	1	–
CBN130900	2"	1	–



142

Balancing valve. CR dezincification resistant alloy body. Max. working pressure: 16 bar. Temperature range: -10–120 °C. Max. percentage of glycol: 50 %.

Code		Kv (m <sup>3</sup> /h)		
142340	1/2"	0,32–2,96	10	–
142345	1/2"	0,15–1,60	10	–
142350	3/4"	0,47–4,35	10	–

130

tech. broch. 01251

Balancing valve for hydraulic systems. Body: - DN 65–200: grey cast iron - DN 250 e 300: ductile cast iron Obturator: - DN 65–200: technopolymer - DN 250 e 300: ductile cast iron Complete with pressure ports.



Max. working pressure: 16 bar. Temperature range: DN 65–DN 300: -10–120 °C. Max. percentage of glycol: 50 %. Flanged connections PN 16. To be coupled with flat counterflanges EN 1092-1.

Code			
130063	DN 65	1	–
130083	DN 80	1	–
130103	DN 100	1	–
130123	DN 125	1	–
130153	DN 150	1	–
130203	DN 200	1	–
130253	DN 250	1	–
130303	DN 300	1	–

130

tech. broch. 01251

Electronic flow rate and differential pressure measuring station. Supplied complete with shut-off and connection fittings. Can be used for measuring the flow rate of balancing valves 130, 142 series and of the flow metering device 683 series. Suitable for Δp measurement of automatic flow rate regulators. Electric supply from battery. Bluetooth® transmission between Δp measuring station and remote control unit. Versions complete with remote control unit with Android® application for Smartphone and Tablet. Measurement range: 0–1000 kPa. Static Pmax: 1000 kPa.



Smart Balancing Caleffi Available app for smartphone. Download for your Android® mobile phone.

Code			
130006	complete with remote control unit, with Android® application	1	–
130005	without remote control unit, with Android® application	1	–

**BALANCING VALVE WITH FLOW METER**



**132**

tech. broch. 01149

Balancing valve with flow meter.  
Direct reading of flow rate.  
Brass valve body and flow meter.  
Ball valve for flow rate adjustment.  
Graduated scale flow meter with magnetic movement flow rate indicator.

**With insulation.**

Max. working pressure: 10 bar.  
Temperature range: -10–110 °C.  
Max. percentage of glycol: 50 %.  
PATENT.



Code	Flow rate range (l/min)		
132402	1/2" 2– 7	1	5
132512	3/4" 5– 13	1	5
132522	3/4" 7– 28	1	5
132602	1" 10– 40	1	5
132702	1 1/4" 20– 70	1	5
132802	1 1/2" 30–120	1	5
132902	2" 50–200	1	5



**132**

Balancing valve with flow meter.  
Direct reading of flow rate.  
Cast iron body.  
Brass flow meter.  
Characterized ball valve for flow rate adjustment.  
Graduated scale flow meter with magnetic movement flow rate indicator.  
Max. working pressure: 10 bar.  
Temperature range: -10–110 °C.  
Max. percentage of glycol: 50 %.  
Flanged connections PN 16.  
To be coupled with flat counterflanges EN 1092-1.  
PATENT.

Code	Flow rate range (m <sup>3</sup> /h)		
132060	DN 65 6–24	1	–
132080	DN 80 8–32	1	–
132100	DN 100 12–48	1	–

**Flow rate adjustment**

The flow rate is adjusted by carrying out the following operations:

1. With the aid of the indicator (1), mark the reference flow rate at which the valve has to be set.
2. Use the ring (2) to open the obturator that shuts off the flow of medium in the flow meter (3) under normal operating conditions.

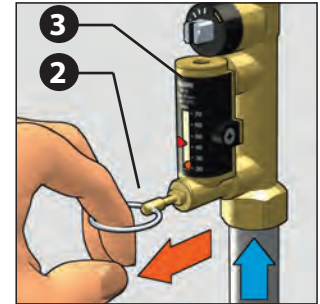
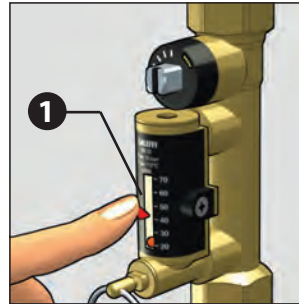

3. Keeping the obturator open, apply a wrench on the control stem of the valve (4) to adjust the flow rate. It is indicated by a metal ball (5) that runs inside a transparent guide (6) marked by a graduated scale in l/min.

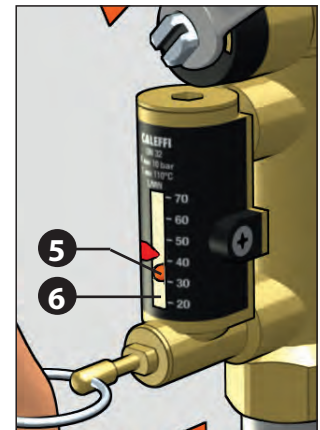
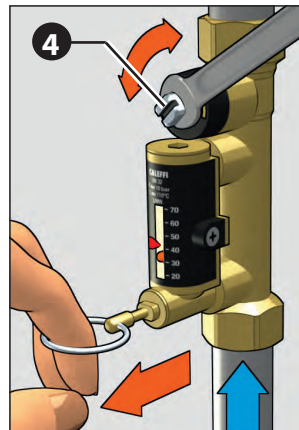

4. After completing the balancing, release the ring (2) of the flow meter obturator that, thanks to an internal spring, will automatically go back into the closed position.
5. After completing the balancing, the indicator (1) can be used to keep in memory the selected setting in case of future inspections.

**Complete opening and closing of the valve**

Complete opening of the valve

Complete closing of the valve

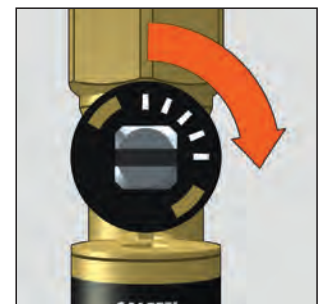
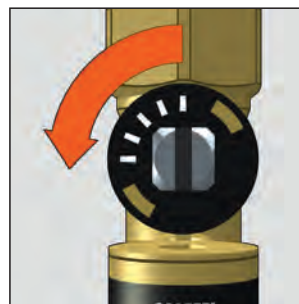



## DYNAMIC BALANCING AND CONTROL DEVICES

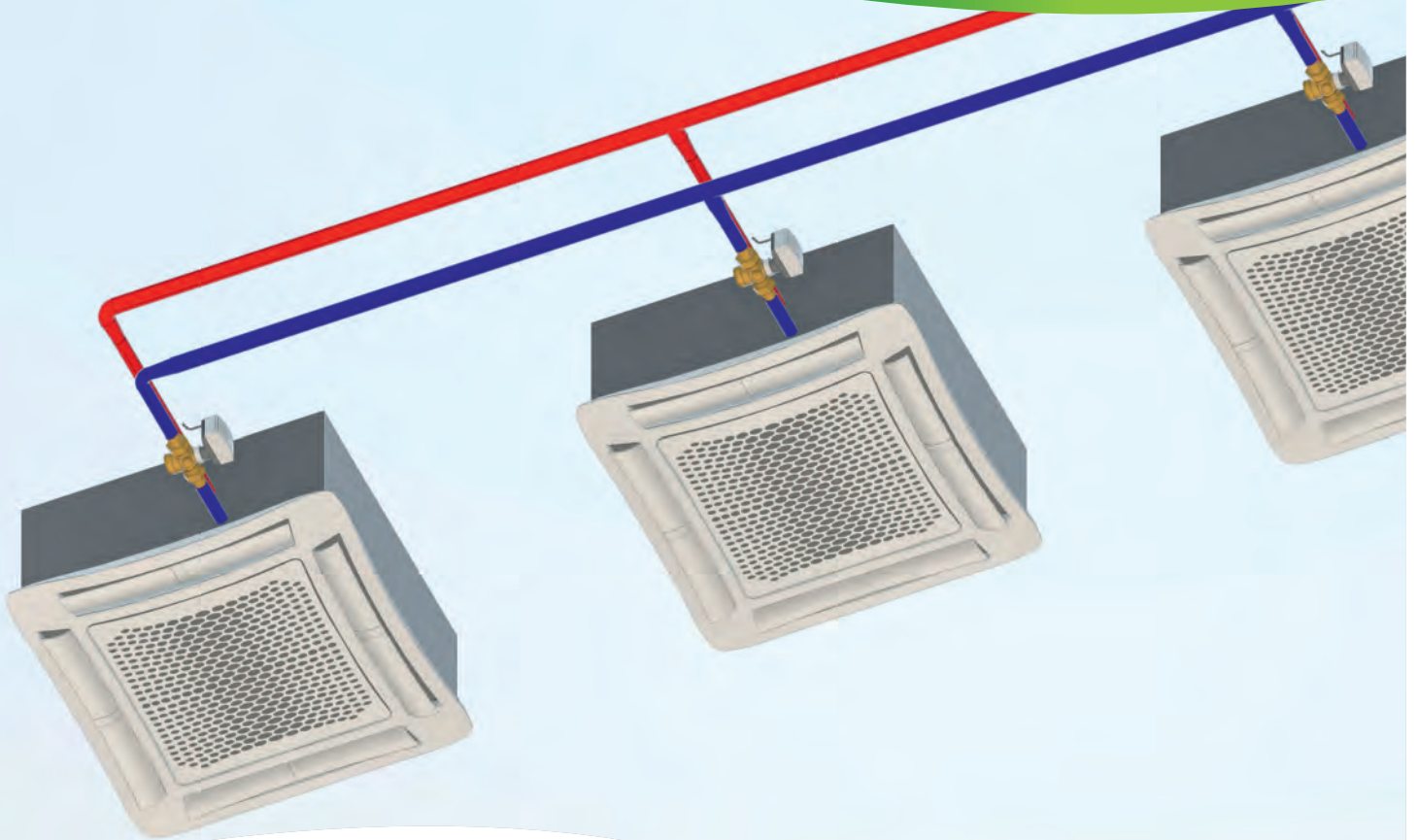

*Diagrams made with BIM families: [bim.caleffi.com](http://bim.caleffi.com)*

- Pressure independent control valve (PICV)**
- Connection and regulation kit for HVAC terminal units**
- Automatic flow rate regulator**
- Automatic flow rate regulator with stainless steel cartridge - flanged connections**

**PRESSURE INDEPENDENT CONTROL VALVE (PICV)**



**145 FLOWMATIC®**

tech. broch. 01262

Pressure independent control valve FLOWMATIC®. CR dezincification resistant alloy body. Male connections. Flow rate regulator in polymer with membrane in EPDM. Graduated scale indicator. Max. working pressure: 25 bar. Temperature range: -20–120 °C. Max. percentage of glycol: 50 %. Δp range: 25–400 kPa. With pressure test ports. **Fitted for 145 series actuator and 6565/6566 series thermo-electric actuator.**

Code	DN	Conn.	Flow rate range (m³/h)		
145437 H20	15	1/2"	0,02–0,20	1	10
145447 H20	15	3/4"	0,02–0,20	1	10
145447 H40	15	3/4"	0,08–0,40	1	10
145447 H80	15	3/4"	0,08–0,80	1	10
145557 H20	20	1"	0,02–0,20	1	10
145557 H40	20	1"	0,08–0,40	1	10
145557 H80	20	1"	0,08–0,80	1	10
145557 1H2	20	1"	0,12–1,20	1	10
145667 1H8	25	1 1/4"	0,18–1,80	1	10
145667 3H0	25	1 1/4"	0,30–3,00	1	10
145667 3H7	25	1 1/4"	0,37–3,70	1	10



Union with gasket.

Code			
145001	1/2" F x 3/8" M	1	–
145003	3/4" F x 1/2" M	1	–
145005	1" F x 3/4" M	1	–
145006	1" F x 1" M	1	–
145007	1 1/4" F x 1" M	1	–
145008	1 1/4" F x 1 1/4" M	1	–

**NEW**



Insulation for FLOWMATIC® 145 series.

Code	Use		
<b>CBN145437</b>	DN 15 - DN 20	1	–

**NEW**



Insulation for FLOWMATIC® 145 series.

Code	Use		
<b>CBN145667</b>	DN 25	1	–

**145 FLOWMATIC®**

tech. broch. 01262



Pressure independent control valve FLOWMATIC®. CR dezincification resistant alloy body. Male connections. Flow rate regulator in polymer with membrane in EPDM. Graduated scale indicator. Max. working pressure: 25 bar. Temperature range: -20–120 °C. Max. percentage of glycol: 50 %. Δp range: 25–400 kPa. Fitted for connection of pressure test ports. **Fitted for 145 series actuator and 6565/6566 series thermo-electric actuator.**

Code	DN	Conn.	Flow rate range (m³/h)		
145434 H20	15	1/2"	0,02–0,20	1	10
<b>145444 H20</b>	15	3/4"	0,02–0,20	1	10
145444 H40	15	3/4"	0,08–0,40	1	10
145444 H80	15	3/4"	0,08–0,80	1	10
145554 H20	20	1"	0,02–0,20	1	10
145554 H40	20	1"	0,08–0,40	1	10
145554 H80	20	1"	0,08–0,80	1	10
145554 1H2	20	1"	0,12–1,20	1	10
145664 1H8	25	1 1/4"	0,18–1,80	1	10
145664 3H0	25	1 1/4"	0,30–3,00	1	10
145664 3H7	25	1 1/4"	0,37–3,70	1	10

ACTUATORS FOR KITS AND CONTROL VALVES (PICV)

**145 FLOWMATIC®**

tech. broch. 01336



Proportional linear actuator for FLOWMATIC® 145 series control valve and 149 series kit.  
 Supply: 24 V (AC)/(DC).  
 Control signal: 0(2)–10 V, 0(4)–20 mA, 0–5 V, 5–10 V.  
 Feedback signal: 0–10 V.  
 Ambient temperature range: 0–50 °C.  
 Protection class: IP 54.  
 Connection: M 30 p.1,5.  
 Supply cable length: 2 m.



Code	Tension V		
145013	24	1	–

**6565**

tech. broch. 01336



Proportional thermo-electric actuator for FLOWMATIC® 145 series control valve and 149 series kit.  
**Quick-coupling installation, with a clip adapter.**  
 Normally closed.  
 Supply: 24 V (AC)/(DC).  
 Control signal: 0–10 V.  
 Feedback signal: 0–10 V.  
 Power consumption: 1,2 W.  
 Ambient temperature range: 0–60 °C.  
 Protection class: IP 54.  
 Connection: M 30 p.1,5.  
 Supply cable length: 1 m.



Code	Tension V	Control signal	Feedback signal		
656524	24	0–10 V	0–10 V	100	–

**NEW 145**

tech. broch. 01367



Proportional linear actuator for FLOWMATIC® 145 series control valve and 149 series kit.  
 Supply: 24 V (AC)/(DC).  
 Control signal: 2 points, 3 points, 0–10 V.  
 Feedback signal: 0–10 V.  
 With manual override.  
 Ambient temperature range: 0–50 °C.  
 Protection class: IP 54.  
 Connection: M 30 p.1,5.  
 Supply cable length: 1,5 m.



Code	Tension V		
145019	24	1	–

**6565/6566**

Thermo-electric actuator for FLOWMATIC® 145 series control valve and 149 series kit.  
**Quick-coupling installation, with a clip adapter.**  
 Supply: 230 V (AC) o 24 V (AC)/(DC).  
 Control signal: ON/OFF.  
 Power consumption: 1 W.  
 Ambient temperature range: 0–60 °C.  
 Protection class: IP 54.  
 Connection: M 30 p.1,5.  
 Supply cable length: 1 m.



Code	Tension V	Control signal		
656502	230	ON/OFF normally closed	100	–
656504	24	ON/OFF normally closed	100	–
656602	230	ON/OFF normally open	100	–
656604	24	ON/OFF normally open	100	–

**NEW 145**

tech. broch. 01367



Proportional linear actuator for FLOWMATIC® 145 series control valve and 149 series kit.  
 Supply: 24 V (AC)/(DC).  
 Control signal: 2 points, 0–10 V.  
 Feedback signal: 0–10 V.  
 With fail-safe function.  
 Ambient temperature range: 0–50 °C.  
 Protection class: IP 54.  
 Connection: M 30 p.1,5.  
 Supply cable length: 1,5 m.



Code	Tension V		
145018	24	1	–

**PRESSURE INDEPENDENT CONTROL VALVE (PICV)**



**145**

Pressure independent control valve.  
Cast iron body.  
Max. working pressure: 25 bar.  
Temperature range: -10-120 °C.  
Max. percentage of glycol: 50 %.  
Δp range: 30-600 kPa.  
With pressure test ports.

Code	DN	Conn.	Flow rate range (m³/h)		
145895	40	2" M	2,9- 9,3	1	-
145905	50	2 1/2" M	5,1-14,8	1	-

Union with gasket for cast iron 145 series.

Code			
145009	2"F x 11/2"M	1	-
145010	2 1/2"F x 2"M	1	-



**145**

Rotational proportional actuator for pressure independent control valve 145 series.  
Supply: 24 V (AC)/(DC).  
Control signal: 2-10 V.  
Feedback signal: 2-10 V.  
Ambient temperature range: -30-50 °C.  
Protection class: IP 54.  
Manual override.



Code	Voltage V	Control signal	Feedback signal	Use		
145017	24	2-10 V	2-10 V	DN 40 - DN 50	1	-



**146**

Manual actuator for 145895 e 145905 valves.

Code		
146001	1	-



**146**

Pressure independent control valve.  
Grey cast iron body.  
Max. working pressure: 16 bar.  
Temperature range: -10-120 °C.  
Max. percentage of glycol: 50 %.  
Δp range: 30-400 kPa.  
With pressure ports.  
Flanged connections PN 16.  
To be coupled with flat counterflanges EN 1092-1.

Code	DN	Flow rate range (m³/h)		
146060	65	6-26	1	-
146080	80	8-36	1	-
146100	100	16-82,5	1	-
146120	125	20-125	1	-
146150	150	27-160	1	-

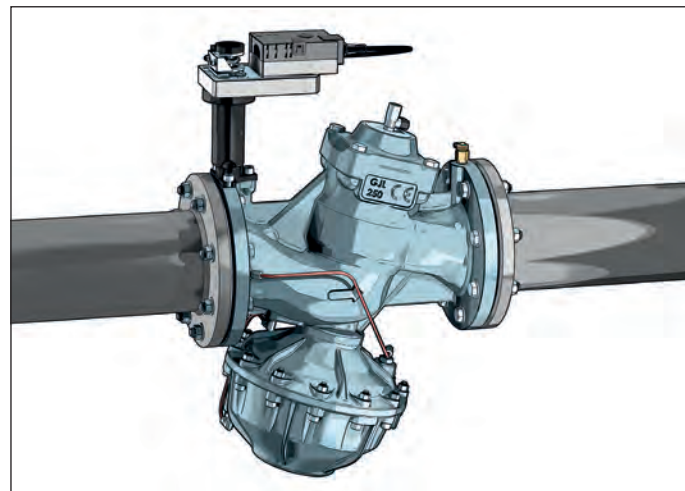

**146**

Manual actuator for 146 series regulating valve.

Code		
146000	1	-



**146**

Rotational proportional actuator for pressure independent control valve 146 series.  
Supply: 24 V (AC)/(DC).  
Control signal: 2-10 V.  
Feedback signal: 2-10 V.  
Ambient temperature range: -30-50 °C.  
Protection class: IP 54.  
Manual override.



Code	Voltage V	Control signal	Feedback signal	Use		
146025	24	2-10 V	2-10 V	DN 65 - DN 150	1	-



## CONNECTION AND REGULATION KIT FOR HVAC TERMINAL UNITS

### 149

tech. broch. 01336

Connection and regulation kit for HVAC terminal units.  
**CR** dezincification resistant alloy body.



- Complete with:
- pressure independent control valve,
  - three-way shut-off valve,
  - integrated by-pass,
  - Venturi device with pressure test ports (only in codes 149.00 ...),
  - filtering cartridge,
  - fill/drain cock.
  - pre-formed shell insulation.

Max. working pressure: 25 bar.  
 Temperature range: -10–120 °C.  
 Max. percentage of glycol: 50 %.  
 Δp range (PICV): 25–400 kPa.  
 Centre distance: **80 mm**.

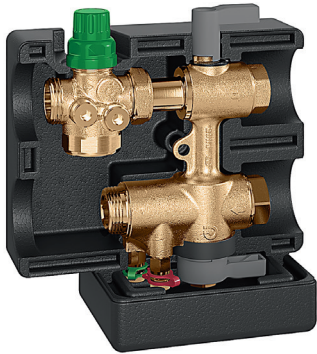
**Fitted for 145 series actuator and 6565/6566 series thermo-electric actuator.**  
 PATENT PENDING.





Optional drain cock for 149 series.

Code	Use			
<b>F0000680</b>	3/4" M x 3/4" F	DN 15	1	-
<b>F0000681</b>	1" M x 1" F	DN 20	1	-
<b>F0000682</b>	1 1/4" M x 1 1/4" F	DN 25	1	-



### 149

Stainless steel flexible hoses.  
 L = 300 mm.  
 PN 25





Code				
<b>149000 530</b>	3/4" F x 3/4" F	DN 16	1	-
<b>149000 630</b>	1" F x 1" F	DN 20	1	-
<b>149000 730</b>	1 1/4" F x 1 1/4" F	DN 25	1	-

#### With Venturi device

Code	DN	Kv Venturi (m³/h)	Flow rates range (m³/h)		
<b>149400 H10</b>	15	0,25	0,02–0,10	1	-
<b>149400 H20</b>	15	0,50	0,10–0,20	1	-
<b>149400 H40</b>	15	1,10	0,20–0,40	1	-
<b>149400 H80</b>	15	2,35	0,40–0,80	1	-
<b>149500 H10</b>	20	0,25	0,02–0,10	1	-
<b>149500 H20</b>	20	0,50	0,10–0,20	1	-
<b>149500 H40</b>	20	1,10	0,20–0,40	1	-
<b>149500 H80</b>	20	2,35	0,40–0,80	1	-
<b>149500 1H2</b>	20	5,00	0,80–1,20	1	-
<b>149600 1H8</b>	25	5,00	1,20–1,80	1	-
<b>149600 3H0</b>	25	9,60	1,80–3,00	1	-
<b>149600 3H7</b>	25	9,60	1,85–3,70	1	-

#### Without Venturi device

Code	DN	Flow rates range (m³/h)		
<b>149410 H20</b>	15	0,02–0,20	1	-
<b>149410 H40</b>	15	0,08–0,40	1	-
<b>149410 H80</b>	15	0,08–0,80	1	-
<b>149510 H20</b>	20	0,02–0,20	1	-
<b>149510 H40</b>	20	0,08–0,40	1	-
<b>149510 H80</b>	20	0,08–0,80	1	-
<b>149510 1H2</b>	20	0,12–1,20	1	-
<b>149610 1H8</b>	25	0,18–1,80	1	-
<b>149610 3H0</b>	25	0,30–3,00	1	-
<b>149610 3H7</b>	25	0,37–3,70	1	-

#### Application diagram of 149 series

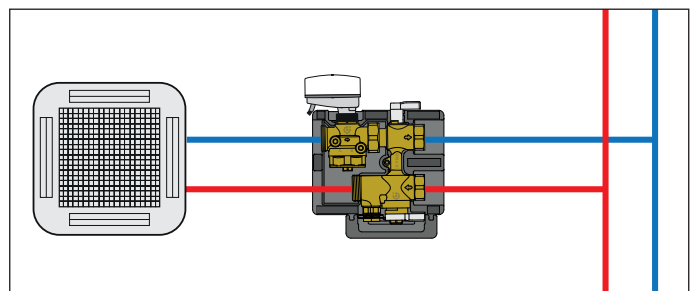

#### Characteristics components

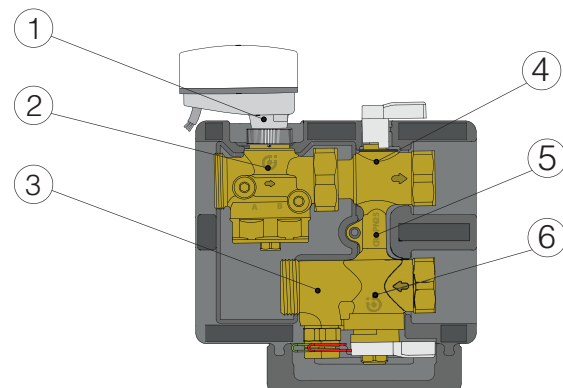

1. Actuator (optional)
2. Pressure independent control valve (PICV)
3. Venturi device for flow rate measurement with connections for pressure test ports (in 149.00 codes only)
4. Three-way shut-off valve
5. By-pass
6. Three-way shut-off valve with built-in strainer

CONNECTION AND REGULATION KIT FOR HVAC TERMINAL UNITS

Lavaggio in by-pass

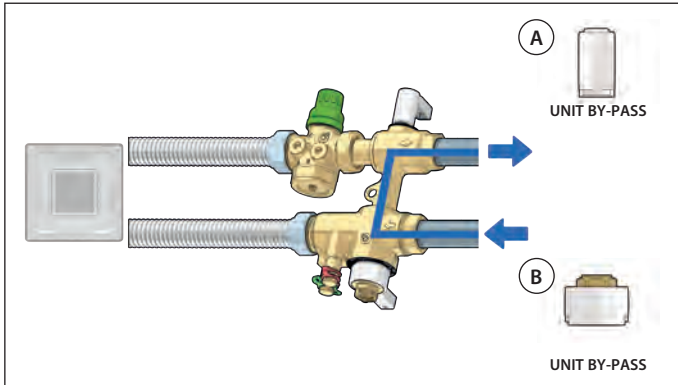

Normale funzionamento

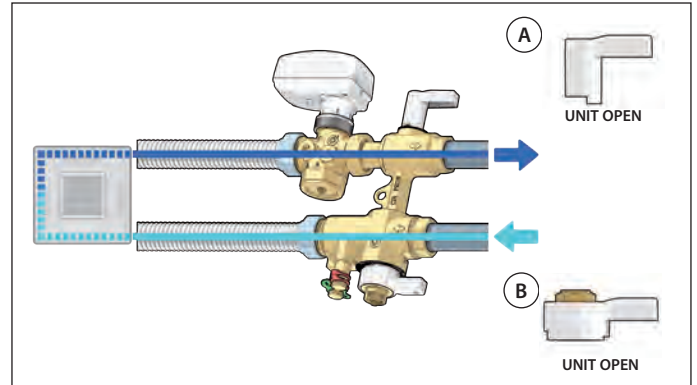

Lavaggio unità terminale

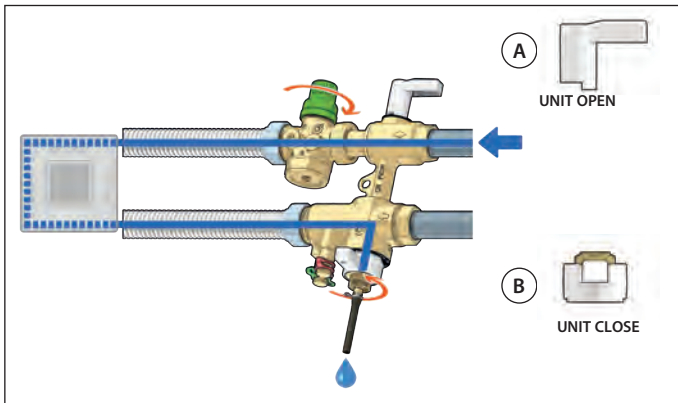

Pulizia filtro/ Isolare la linea

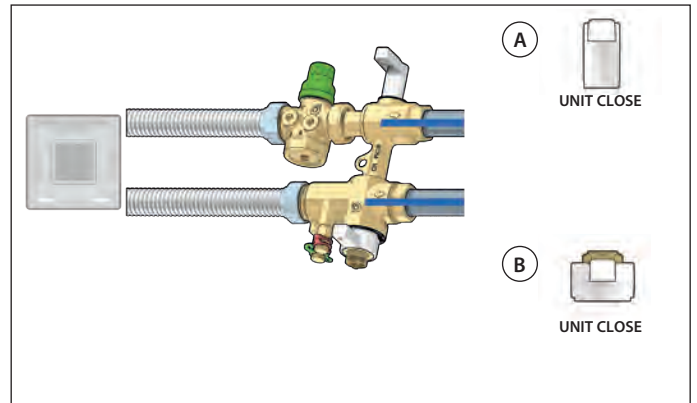

Installazione in controsoffitto a servizio di fancoil

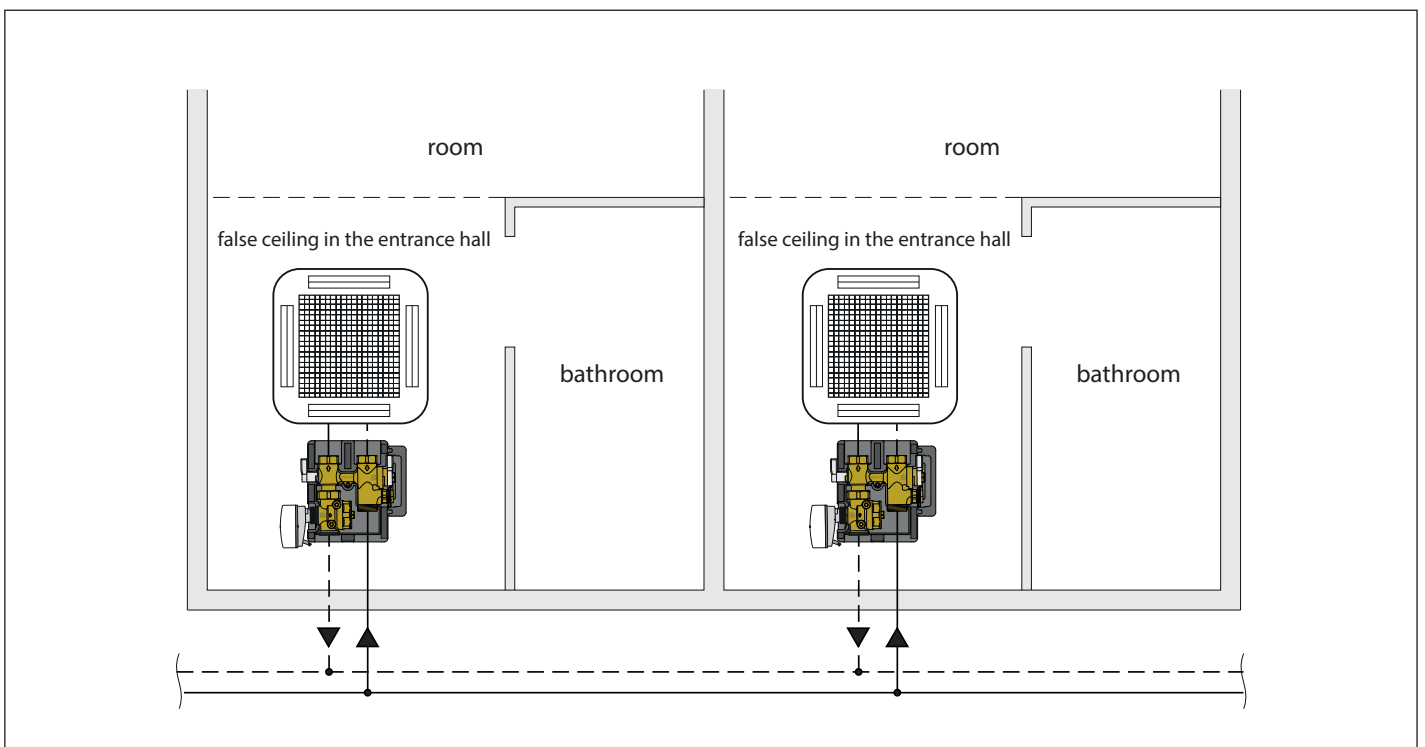

ACTUATORS FOR KITS AND CONTROL VALVES (PICV)

**145 FLOWMATIC®**

tech. broch. 01336



Proportional linear actuator for FLOWMATIC® 145 series control valve and 149 series kit.  
 Supply: 24 V (AC)/(DC).  
 Control signal: 0(2)–10 V, 0(4)–20 mA, 0–5 V, 5–10 V.  
 Feedback signal: 0–10 V.  
 Ambient temperature range: 0–50 °C.  
 Protection class: IP 54.  
 Connection: M 30 p.1,5.  
 Supply cable length: 2 m.



Code	Tension V		
145013	24	1	–

**6565**

tech. broch. 01336



Proportional thermo-electric actuator for FLOWMATIC® 145 series control valve and 149 series kit.  
**Quick-coupling installation, with a clip adapter.**  
 Normally closed.  
 Supply: 24 V (AC)/(DC).  
 Control signal: 0–10 V.  
 Feedback signal: 0–10 V.  
 Power consumption: 1,2 W.  
 Ambient temperature range: 0–60 °C.  
 Protection class: IP 54.  
 Connection: M 30 p.1,5.  
 Supply cable length: 1 m.



Code	Tension V	Control signal	Feedback signal		
656524	24	0–10 V	0–10 V	100	–

**NEW**

**145**

tech. broch. 01367



Proportional linear actuator for FLOWMATIC® 145 series control valve and 149 series kit.  
 Supply: 24 V (AC)/(DC).  
 Control signal: 2 points, 3 points, 0–10 V.  
 Feedback signal: 0–10 V.  
 With manual override.  
 Ambient temperature range: 0–50 °C.  
 Protection class: IP 54.  
 Connection: M 30 p.1,5.  
 Supply cable length: 1,5 m.



Code	Tension V		
145019	24	1	–

**6565/6566**

Thermo-electric actuator for FLOWMATIC® 145 series control valve and 149 series kit.  
**Quick-coupling installation, with a clip adapter.**  
 Supply: 230 V (AC) o 24 V (AC)/(DC).  
 Control signal: ON/OFF.  
 Power consumption: 1 W.  
 Ambient temperature range: 0–60 °C.  
 Protection class: IP 54.  
 Connection: M 30 p.1,5.  
 Supply cable length: 1 m.



Code	Tension V	Control signal		
656502	230	ON/OFF normally closed	100	–
656504	24	ON/OFF normally closed	100	–
656602	230	ON/OFF normally open	100	–
656604	24	ON/OFF normally open	100	–

**NEW**

**145**

tech. broch. 01367



Proportional linear actuator for FLOWMATIC® 145 series control valve and 149 series kit.  
 Supply: 24 V (AC)/(DC).  
 Control signal: 2 points, 0–10 V.  
 Feedback signal: 0–10 V.  
 With fail-safe function.  
 Ambient temperature range: 0–50 °C.  
 Protection class: IP 54.  
 Connection: M 30 p.1,5.  
 Supply cable length: 1,5 m.



Code	Tension V		
145018	24	1	–

CONNECTION AND REGULATION KITS FOR HVAC TERMINAL UNITS

149

tech. broch. 01349

Connection and regulation kit for HVAC terminal units.

CR dezincification resistant alloy body.

Complete with:

- pressure independent control valve,
- three-way shut-off valve,
- filtering cartridge,
- integrated by-pass,
- Venturi device with pressure test ports,
- fill/drain cock.

Max. working pressure: 25 bar.  
 Temperature range: -10-120 °C.  
 Max. percentage of glycol: 50 %.  
 Δp range (PICV): 25-400 kPa.  
 Centre distance: 40 mm.

Fitted for 145 series actuator and 6565/6566 series thermo-electric actuator.

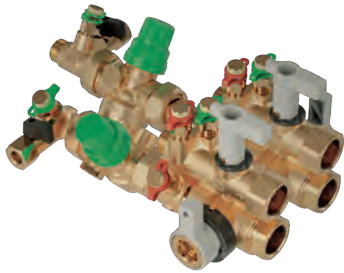



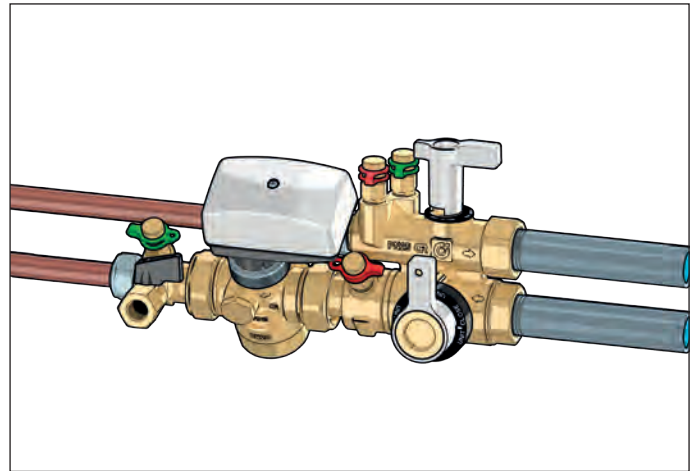

Single installation code 149500 ... 001

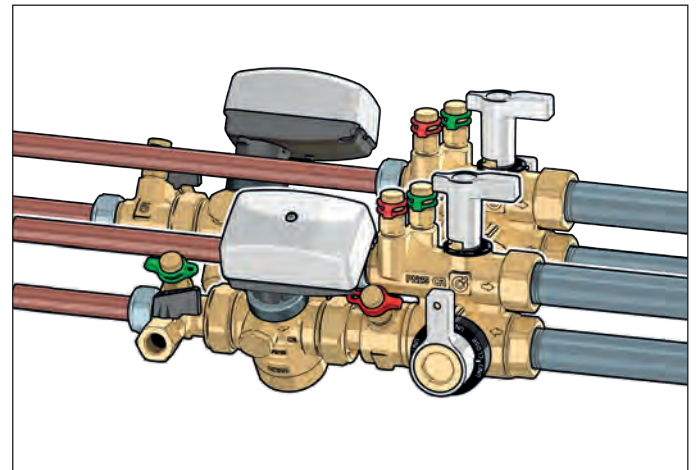

Double installation code 149500 ... 001 + code 149500 ... 002



Code	DN	Kv Venturi (m <sup>3</sup> /h)	Flow rates range (m <sup>3</sup> /h)		
149500 H08 001	20	0,15	0,02-0,08	1	-
149500 H20 001	20	0,50	0,08-0,20	1	-
149500 H40 001	20	1,10	0,20-0,40	1	-
149500 H80 001	20	2,25	0,40-0,80	1	-
149500 1H2 001	20	3,90	0,60-1,20	1	-

Code	DN	Kv Venturi (m <sup>3</sup> /h)	Flow rates range (m <sup>3</sup> /h)		
149500 H08 002	20	0,15	0,02-0,08	1	-
149500 H20 002	20	0,50	0,08-0,20	1	-
149500 H40 002	20	1,10	0,20-0,40	1	-
149500 H80 002	20	2,25	0,40-0,80	1	-
149500 1H2 002	20	3,90	0,60-1,20	1	-

## COMPACT AUTOMATIC FLOW RATE REGULATOR WITH HIGH RESISTANCE POLYMER CARTRIDGE



### 127 AUTOFLOW®

tech. broch. 01166

Compact automatic flow rate regulator.

Brass body.

AUTOFLOW® cartridge:

1/2"-11/4" in high resistance polymer,

1 1/2" - 2" in high resistance polymer and stainless steel.

Max. working pressure: 16 bar.

Temperature range: 0-100 °C.

Max. percentage of glycol: 50 %.

Flow rates: 0,02-0,06 m³/h - Δp range: 20-200 kPa - Accuracy: ± 15 %.

Flow rates: 0,085-11,0 m³/h - Δp range: 15-200 kPa - Accuracy: ± 10 % PATENT.

Code				
127141 ●●●	1/2"		1	-
127151 ●●●	3/4"		1	-
127161 ●●●	1"		1	-
127171 ●●●	1 1/4"		1	-
127181 ●●●	1 1/2"		1	-
127191 ●●●	2"		1	-

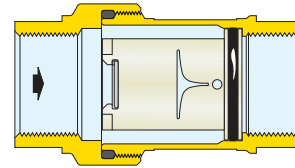

Code	Min. working Δp (kPa)	Δp range (kPa)	Flow rates (m³/h)
127141 ●●●	15	15-200 (20-200*)	0,02*; 0,04*; 0,06*; 0,085; 0,12; 0,15; 0,2; 0,25; 0,3; 0,35; 0,4; 0,5; 0,6; 0,7; 0,8; 0,9; 1,0; 1,2; 1,4
127151 ●●●	15	15-200 (20-200*)	0,02*; 0,04*; 0,06*; 0,085; 0,12; 0,15; 0,2; 0,25; 0,3; 0,35; 0,4; 0,5; 0,6; 0,7; 0,8; 0,9; 1,0; 1,2; 1,4; 1,6
127161 ●●●	15	15-200	0,5; 0,6; 0,7; 0,8; 0,9; 1,0; 1,2; 1,4; 1,6; 1,8; 2,0; 2,25; 2,5; 2,75; 3,0; 3,25; 3,5; 3,75; 4,0; 4,25; 4,5; 4,75; 5,0
127171 ●●●	15	15-200	0,5; 0,6; 0,7; 0,8; 0,9; 1,0; 1,2; 1,4; 1,6; 1,8; 2,0; 2,25; 2,5; 2,75; 3,0; 3,25; 3,5; 3,75; 4,0; 4,25; 4,5; 4,75; 5,0
127181 ●●●	15	15-200	4,5; 4,75; 5,0; 5,5; 6,0; 6,5; 7,0; 7,5; 8,0; 8,5; 9,0; 9,5; 10,0; 11,0
127191 ●●●	15	15-200	4,5; 4,75; 5,0; 5,5; 6,0; 6,5; 7,0; 7,5; 8,0; 8,5; 9,0; 9,5; 10,0; 11,0

## AUTOMATIC FLOW RATE REGULATOR WITH HIGH RESISTANCE POLYMER CARTRIDGE AND BALL VALVE



### 128 AUTOFLOW®

tech. broch. 01269

Compact automatic flow rate regulator.

Brass body.

AUTOFLOW® cartridge: in high resistance polymer.

Max. working pressure: 16 bar.

Temperature range: 0-100 °C.

Max. percentage of glycol: 50 %.

Flow rates: 0,02-0,06 m³/h - Δp range: 20-200 kPa - Accuracy: ± 15 %.

Flow rates: 0,085-5,0 m³/h - Δp range: 15-200 kPa - Accuracy: ± 10 %.

Code				
128141 ●●●	1/2" F		1	-
128151 ●●●	3/4" F		1	-
128161 ●●●	1" F		1	-
128171 ●●●	1 1/4" F		1	-

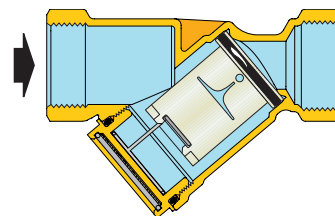

Insulation for Compact automatic flow rate regulator 128 series.

Code	Use		
CBN128141	128141-128151	1	-
CBN128161	128161-128171	1	-

Code	Kv (m³/h)	Min. working Δp (kPa)	Δp range (kPa)	Flow rates (m³/h)
128141 ●●●	6,69	15	15-200 (20-200*)	0,02*; 0,04*; 0,06*; 0,085; 0,12; 0,15; 0,2; 0,25; 0,3; 0,35; 0,4; 0,5; 0,6; 0,7; 0,8; 0,9; 1,0; 1,2
128151 ●●●	7,58	15	15-200 (20-200*)	0,02*; 0,04*; 0,06*; 0,085; 0,12; 0,15; 0,2; 0,25; 0,3; 0,35; 0,4; 0,5; 0,6; 0,7; 0,8; 0,9; 1,0; 1,2; 1,4
128161 ●●●	14,00	15	15-200	0,5; 0,6; 0,7; 0,8; 0,9; 1,0; 1,2; 1,4; 1,6; 1,8; 2,0; 2,2; 2,5; 2,7; 3,0; 3,2; 3,5; 3,7; 4,0; 4,2; 4,5; 4,7; 5,0
128171 ●●●	14,50	15	15-200	0,5; 0,6; 0,7; 0,8; 0,9; 1,0; 1,2; 1,4; 1,6; 1,8; 2,0; 2,2; 2,5; 2,7; 3,0; 3,2; 3,5; 3,7; 4,0; 4,2; 4,5; 4,7; 5,0

## AUTOMATIC FLOW RATE REGULATOR WITH HIGH RESISTANCE POLYMER CARTRIDGE



tech. broch. 01141

### 126 AUTOFLOW®

Automatic flow rate regulator.  
**CR** dezincification resistant alloy body.  
 AUTOFLOW® cartridge:  
 1/2"-11/4" in high resistance polymer,  
 1 1/2" - 2" in high resistance polymer and stainless steel.  
 Max. working pressure: 25 bar.  
 Temperature range: -20-100 °C.  
 Max. percentage of glycol: 50 %.  
 Δp range: 15-200 kPa.  
 Flow rates: 0,085-11,0 m³/h.  
 Accuracy: ± 10 %.

Fitted for connection of pressure ports and drain valve.  
 PATENT.

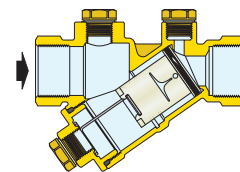

Code			
126141 ●●●	1/2"	1	-
126151 ●●●	3/4"	1	-
126161 ●●●	1"	1	-
126171 ●●●	1 1/4"	1	-
126181 ●●●	1 1/2"	1	-
126191 ●●●	2"	1	-

Code	Kv (m³/h)	Min. working Δp (kPa)	Δp range (kPa)	Flow rates (m³/h)
126141 ●●●	6,69	15	15-200	0,085; 0,12; 0,15; 0,2; 0,25; 0,3; 0,35; 0,4; 0,5; 0,6; 0,7; 0,8; 0,9; 1,0; 1,2
126151 ●●●	7,58	15	15-200	0,085; 0,12; 0,15; 0,2; 0,25; 0,3; 0,35; 0,4; 0,5; 0,6; 0,7; 0,8; 0,9; 1,0; 1,2; 1,4; 1,6
126161 ●●●	14,00	15	15-200	0,5; 0,6; 0,7; 0,8; 0,9; 1,0; 1,2; 1,4; 1,6; 1,8; 2,0; 2,25; 2,5; 2,75; 3,0; 3,25; 3,5; 3,75; 4,0; 4,25; 4,5; 4,75; 5,0
126171 ●●●	14,50	15	15-200	0,5; 0,6; 0,7; 0,8; 0,9; 1,0; 1,2; 1,4; 1,6; 1,8; 2,0; 2,25; 2,5; 2,75; 3,0; 3,25; 3,5; 3,75; 4,0; 4,25; 4,5; 4,75; 5,0
126181 ●●●	34,72	15	15-200	5,5; 6,0; 6,5; 7,0; 7,5; 8,0; 8,5; 9,0; 9,5; 10,0; 11,0
126191 ●●●	37,38	15	15-200	5,5; 6,0; 6,5; 7,0; 7,5; 8,0; 8,5; 9,0; 9,5; 10,0; 11,0

## AUTOMATIC FLOW RATE REGULATOR WITH HIGH RESISTANCE POLYMER CARTRIDGE AND BALL VALVE



tech. broch. 01141

### 121 AUTOFLOW®

Combination of automatic flow rate regulator and ball valve.  
**CR** dezincification resistant alloy body.  
 AUTOFLOW® cartridge:  
 1/2"-11/4" in high resistance polymer,  
 1 1/2" - 2" in high resistance polymer and stainless steel.  
 Max. working pressure: 25 bar.  
 Temperature range: -20-100 °C.  
 Max. percentage of glycol: 50 %.  
 Δp range: 15-200 kPa.  
 Flow rates: 0,085-11,0 m³/h.  
 Accuracy: ± 10 %.

Fitted for connection of pressure ports and drain valve.  
 PATENT.

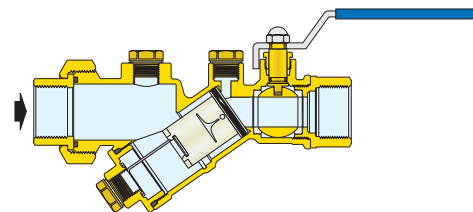

Code			
121141 ●●●	1/2"	1	-
121151 ●●●	3/4"	1	-
121161 ●●●	1"	1	-
121171 ●●●	1 1/4"	1	-
121181 ●●●	1 1/2"	1	-
121191 ●●●	2"	1	-

Code	Kv (m³/h)	Min. working Δp (kPa)	Δp range (kPa)	Flow rates (m³/h)
121141 ●●●	6,90	15	15-200	0,085; 0,12; 0,15; 0,2; 0,25; 0,3; 0,35; 0,4; 0,5; 0,6; 0,7; 0,8; 0,9; 1,0; 1,2
121151 ●●●	7,73	15	15-200	0,085; 0,12; 0,15; 0,2; 0,25; 0,3; 0,35; 0,4; 0,5; 0,6; 0,7; 0,8; 0,9; 1,0; 1,2; 1,4; 1,6
121161 ●●●	18,00	15	15-200	0,5; 0,6; 0,7; 0,8; 0,9; 1,0; 1,2; 1,4; 1,6; 1,8; 2,0; 2,25; 2,5; 2,75; 3,0; 3,25; 3,5; 3,75; 4,0; 4,25; 4,5; 4,75; 5,0
121171 ●●●	18,50	15	15-200	0,5; 0,6; 0,7; 0,8; 0,9; 1,0; 1,2; 1,4; 1,6; 1,8; 2,0; 2,25; 2,5; 2,75; 3,0; 3,25; 3,5; 3,75; 4,0; 4,25; 4,5; 4,75; 5,0
121181 ●●●	47,24	15	15-200	5,5; 6,0; 6,5; 7,0; 7,5; 8,0; 8,5; 9,0; 9,5; 10,0; 11,0
121191 ●●●	48,89	15	15-200	5,5; 6,0; 6,5; 7,0; 7,5; 8,0; 8,5; 9,0; 9,5; 10,0; 11,0

## Method of coding AUTOFLOW® 121 - 126 - 127 - 128 series

For correct identification of the device, fill in the form indicating: series, size, flow rate and Δp range.

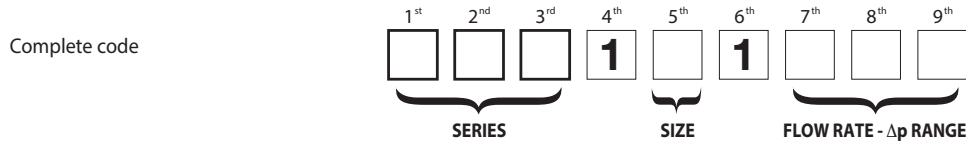

### SERIES

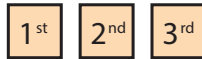

The first three digits indicate the series

121	AUTOFLOW® regulator and ball valve
126	AUTOFLOW® regulator
127	AUTOFLOW® compact regulator
128	AUTOFLOW® compact regulator

### SIZE



The fifth digit indicates the size

Size	1/2"	3/4"	1"	1 1/4"	1 1/2"	2"
Digit	4	5	6	7	8	9

### FLOW RATE - Δp RANGE

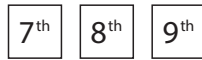

The last three digits indicate the available flow rate

Δp range 20–200 kPa					
m <sup>3</sup> /h	digit	m <sup>3</sup> /h	digit	m <sup>3</sup> /h	digit
0,02	M02	0,04	M04	0,06	M06

Δp range 15–200 kPa											
m <sup>3</sup> /h	digit	m <sup>3</sup> /h	digit	m <sup>3</sup> /h	digit	m <sup>3</sup> /h	digit	m <sup>3</sup> /h	digit	m <sup>3</sup> /h	digit
0,085	M08	0,40	M40	1,20	1M2	2,75	2M7	4,50	4M5	7,50	7M5
0,12	M12	0,50	M50	1,40	1M4	3,00	3M0	4,75	4M7	8,00	8M0
0,15	M15	0,60	M60	1,60	1M6	3,25	3M2	5,00	5M0	8,50	8M5
0,20	M20	0,70	M70	1,80	1M8	3,50	3M5	5,50	5M5	9,00	9M0
0,25	M25	0,80	M80	2,00	2M0	3,75	3M7	6,00	6M0	9,50	9M5
0,30	M30	0,90	M90	2,25	2M2	4,00	4M0	6,50	6M5	10,0	10M
0,35	M35	1,00	1M0	2,50	2M5	4,25	4M2	7,00	7M0	11,0	11M

### Minimum differential pressure required

This is given by the sum of two values:

1. the minimum working Δp of the AUTOFLOW® cartridge;
2. the Δp required for the nominal flow rate to pass through the valve body. This value can be determined on the basis of the values of Kv shown above referring to the valve body.

Pump head H = Δp<sub>circuit</sub> + Δp<sub>required</sub>

## SPARE POLYMER CARTRIDGES. For 127 series.



For 1/2" - 3/4" bodies

Code	Flow rate (m <sup>3</sup> /h)
02M02 XXG	0,020
02M04 XXG	0,040
02M06 XXG	0,060
02M08 XXG	0,085
02M12 XXG	0,12
02M15 XXG	0,15
02M20 XXG	0,20
02M25 XXG	0,25
02M30 XXG	0,30
02M35 XXG	0,35
02M40 XXG	0,40
02M50 XXG	0,50
02M60 XXG	0,60
02M70 XXG	0,70
02M80 XXG	0,80
02M90 XXG	0,90
021M0 XXG	1,00
021M2 XXG	1,20
021M4 XXG	1,40
021M6 XXG	1,60



For 1" - 1 1/4" bodies, with adapter

Code	Flow rate (m <sup>3</sup> /h)
02M50 XXH	0,50
02M60 XXH	0,60
02M70 XXH	0,70
02M80 XXH	0,80
02M90 XXH	0,90
021M0 XXH	1,00
021M2 XXH	1,20
021M4 XXH	1,40
021M6 XXH	1,60



For 1" - 1 1/4" bodies

Code	Flow rate (m <sup>3</sup> /h)
041M8 XXH	1,80
042M0 XXH	2,00
042M2 XXH	2,25
042M5 XXH	2,50
042M7 XXH	2,75
043M0 XXH	3,00
043M2 XXH	3,25
043M5 XXH	3,50
043M7 XXH	3,75
044M0 XXH	4,00
044M2 XXH	4,25
044M5 XXH	4,50
044M7 XXH	4,75
045M0 XXH	5,00



For 1 1/2" - 2" bodies, with adapter

Code	Flow rate (m <sup>3</sup> /h)
044M5 XXI	4,50
044M7 XXI	4,75
045M0 XXI	5,00



For 1 1/2" - 2" bodies

Code	Flow rate (m <sup>3</sup> /h)
055M5 XXI	5,50
056M0 XXI	6,00
056M5 XXI	6,50
057M0 XXI	7,00
057M5 XXI	7,50
058M0 XXI	8,00
058M5 XXI	8,50
059M0 XXI	9,00
059M5 XXI	9,50
0510M XXI	10,0
0511M XXI	11,0

Spare AUTOFLOW® cartridge complete with label for fixing to the body of the AUTOFLOW® device.

**SPARE POLYMER CARTRIDGES. For 128 series.**



For 1/2" - 3/4" bodies

Code	Flow rate (m <sup>3</sup> /h)
02M02 XXL	0,02
02M04 XXL	0,04
02M06 XXL	0,06
02M08 XXL	0,085
02M12 XXL	0,12
02M15 XXL	0,15
02M20 XXL	0,20
02M25 XXL	0,25
02M30 XXL	0,30
02M35 XXL	0,35
02M40 XXL	0,40
02M50 XXL	0,50
02M60 XXL	0,60
02M70 XXL	0,70
02M80 XXL	0,80
02M90 XXL	0,90
021M0 XXL	1,00
021M2 XXL	1,20
021M4 XXL	1,40



For 1" - 1 1/4" bodies, with adapter

Code	Flow rate (m <sup>3</sup> /h)
02M50 XXM	0,50
02M60 XXM	0,60
02M70 XXM	0,70
02M80 XXM	0,80
02M90 XXM	0,90
021M0 XXM	1,00
021M2 XXM	1,20
021M4 XXM	1,40
021M6 XXM	1,60



For 1" - 1 1/4" bodies

Code	Flow rate (m <sup>3</sup> /h)
041M8 XXM	1,80
042M0 XXM	2,00
042M2 XXM	2,25
042M5 XXM	2,50
042M7 XXM	2,75
043M0 XXM	3,00
043M2 XXM	3,25
043M5 XXM	3,50
043M7 XXM	3,75
044M0 XXM	4,00
044M2 XXM	4,25
044M5 XXM	4,50
044M7 XXM	4,75
045M0 XXM	5,00

Spare AUTOFLOW® cartridge complete with metal tag and metal chain for fixing to the body of the AUTOFLOW® device.

**SPARE POLYMER CARTRIDGES. For 121 - 126 series.**



For 1/2" - 3/4" bodies

Code	Flow rate (m <sup>3</sup> /h)
02M08 XXX	0,085
02M12 XXX	0,12
02M15 XXX	0,15
02M20 XXX	0,20
02M25 XXX	0,25
02M30 XXX	0,30
02M35 XXX	0,35
02M40 XXX	0,40
02M50 XXX	0,50
02M60 XXX	0,60
02M70 XXX	0,70
02M80 XXX	0,80
02M90 XXX	0,90
021M0 XXX	1,00
021M2 XXX	1,20
021M4 XXX	1,40
021M6 XXX	1,60



For 1" - 1 1/4" bodies, with adapter

Code	Flow rate (m <sup>3</sup> /h)
02M50 XXC	0,50
02M60 XXC	0,60
02M70 XXC	0,70
02M80 XXC	0,80
02M90 XXC	0,90
021M0 XXC	1,00
021M2 XXC	1,20
021M4 XXC	1,40
021M6 XXC	1,60



For 1" - 1 1/4" bodies

Code	Flow rate (m <sup>3</sup> /h)
041M8 XXC	1,80
042M0 XXC	2,00
042M2 XXC	2,25
042M5 XXC	2,50
042M7 XXC	2,75
043M0 XXC	3,00
043M2 XXC	3,25
043M5 XXC	3,50
043M7 XXC	3,75
044M0 XXC	4,00
044M2 XXC	4,25
044M5 XXC	4,50
044M7 XXC	4,75
045M0 XXC	5,00



For 1 1/2" - 2" bodies

Code	Flow rate (m <sup>3</sup> /h)
055M5 XXD	5,50
056M0 XXD	6,00
056M5 XXD	6,50
057M0 XXD	7,00
057M5 XXD	7,50
058M0 XXD	8,00
058M5 XXD	8,50
059M0 XXD	9,00
059M5 XXD	9,50
0510M XXD	10,0
0511M XXD	11,0

**NOTE:** When ordering, give the full code of the AUTOFLOW® device into which the cartridge is to be fitted (code shown on the metal plate supplied with every AUTOFLOW® device).

Spare AUTOFLOW® cartridge complete with metal tag for fixing to the body of the AUTOFLOW® device.



## AUTOMATIC FLOW RATE REGULATOR WITH STAINLESS STEEL CARTRIDGE AND BALL VALVE

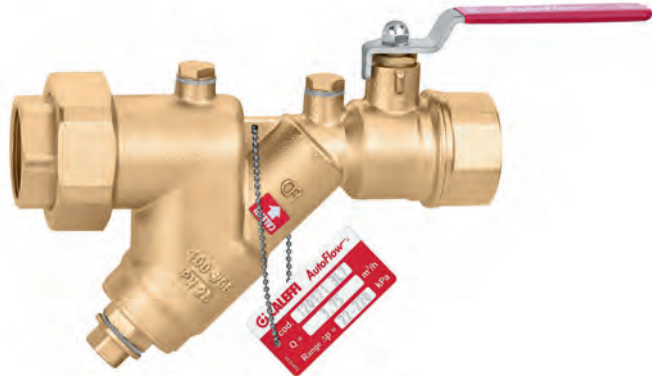

### 120 AUTOFLOW®

tech. broch. 01041

Combination of automatic flow rate regulator and ball valve.  
**CR** dezincification resistant alloy body.  
 Stainless steel AUTOFLOW® cartridge.  
 Max. working pressure: 25 bar.  
 Temperature range: 0–110 °C.  
 Max. percentage of glycol: 50 %.  
 Δp range: 10–95 kPa; 22–210 kPa; 40–390 kPa.  
 Flow rates: 0,12–15,5 m<sup>3</sup>/h.  
 Accuracy: ± 5 %.

Fitted for connection of pressure ports and drain valve.

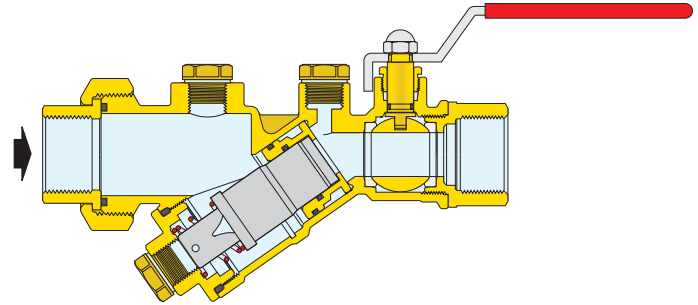

Code			
120141 ●●●	1/2"	1	–
120151 ●●●	3/4"	1	–
120161 ●●●	1"	1	–
120171 ●●●	1 1/4"	1	–
120181 ●●●	1 1/2"	1	–
120191 ●●●	2"	1	–

Code	Kv (m <sup>3</sup> /h)	Min. working Δp (kPa)	Δp range (kPa)	Flow rates (m <sup>3</sup> /h)
120141 ●●●	6,90	10	10–95	0,3; 0,45; 0,5; 0,6; 0,7; 0,8; 0,9; 1,0
120151 ●●●	7,73	10	10–95	0,3; 0,45; 0,5; 0,6; 0,7; 0,8; 0,9; 1,0
120161 ●●●	17,04	10	10–95	0,7; 0,8; 0,9; 1,0
120171 ●●●	17,74	10	10–95	0,7; 0,8; 0,9; 1,0
120181 ●●●	47,24	10	10–95	2,75; 3,0; 3,25; 3,5; 3,75; 4,25; 5,0; 7,0;
120191 ●●●	48,89	10	10–95	2,75; 3,0; 3,25; 3,5; 3,75; 4,25; 5,0; 7,0;

Code	Kv (m <sup>3</sup> /h)	Min. working Δp (kPa)	Δp range (kPa)	Flow rates (m <sup>3</sup> /h)
120141 ●●●	6,90	22	22–210	0,12; 0,15; 0,2; 0,25; 0,35; 0,4; 0,6; 0,7; 0,8; 0,9; 1,2; 1,4; 1,6; 1,8
120151 ●●●	7,73	22	22–210	0,12; 0,15; 0,2; 0,25; 0,35; 0,4; 0,6; 0,7; 0,8; 0,9; 1,2; 1,4; 1,6; 1,8
120161 ●●●	17,04	22	22–210	1,0; 1,2; 1,4; 1,6; 1,8; 2,0; 2,25; 2,5; 2,75; 3,0; 3,25; 3,5; 3,75; 4,0; 4,25
120171 ●●●	17,74	22	22–210	1,0; 1,2; 1,4; 1,6; 1,8; 2,0; 2,25; 2,5; 2,75; 3,0; 3,25; 3,5; 3,75; 4,0; 4,25
120181 ●●●	47,24	22	22–210	4,0; 4,5; 5,5; 6,0; 6,5; 7,5; 8,0; 8,5; 9,0; 9,5; 10,0; 11,0
120191 ●●●	48,89	22	22–210	4,0; 4,5; 5,5; 6,0; 6,5; 7,5; 8,0; 8,5; 9,0; 9,5; 10,0; 11,0

Code	Kv (m <sup>3</sup> /h)	Min. working Δp (kPa)	Δp range (kPa)	Flow rates (m <sup>3</sup> /h)
120141 ●●●	6,90	40	40–390	0,25; 0,35; 0,45; 0,7; 0,9; 1,1; 1,4; 1,6; 1,8; 2,1; 2,25; 2,5; 2,75
120151 ●●●	7,73	40	40–390	0,25; 0,35; 0,45; 0,7; 0,9; 1,1; 1,4; 1,6; 1,8; 2,1; 2,25; 2,5; 2,75
120161 ●●●	17,04	40	40–390	1,6; 1,8; 2,1; 2,25; 2,5; 2,75; 3,0; 3,25; 3,5; 3,75; 4,0; 4,25; 4,5; 5,0; 5,5; 6,0
120171 ●●●	17,74	40	40–390	1,6; 1,8; 2,1; 2,25; 2,5; 2,75; 3,0; 3,25; 3,5; 3,75; 4,0; 4,25; 4,5; 5,0; 5,5; 6,0
120181 ●●●	47,24	40	40–390	3,0; 3,25; 3,5; 3,75; 4,0; 4,25; 4,5; 6,5; 7,0; 7,5; 8,0; 8,5; 9,0; 10,0; 11,0; 12,0; 13,0; 14,5; 15,5
120191 ●●●	48,89	40	40–390	3,0; 3,25; 3,5; 3,75; 4,0; 4,25; 4,5; 6,5; 7,0; 7,5; 8,0; 8,5; 9,0; 10,0; 11,0; 12,0; 13,0; 14,5; 15,5

●●● For code completion see method of coding on page 257

#### Minimum differential pressure required

This is given by the sum of two values:

1. the minimum working Δp of the AUTOFLOW® cartridge;
2. the Δp required for the nominal flow rate to pass through the valve body. This value can be determined on the basis of the values of Kv shown above referring to the valve body.

$$\text{Pump head } H = \Delta p_{\text{circuit}} + \Delta p_{\text{require}}$$

## AUTOMATIC FLOW RATE REGULATOR WITH STAINLESS STEEL CARTRIDGE



### 125 AUTOFLOW®

tech. broch. 01041

Automatic flow rate regulator.  
 CR dezincification resistant alloy body.  
 Stainless steel AUTOFLOW® cartridge.  
 Max. working pressure: 25 bar.  
 Temperature range: -20–110 °C.  
 Max. percentage of glycol: 50 %.  
 Δp range: 10–95 kPa; 22–210 kPa; 40–390 kPa.  
 Flow rates: 0,12–22 m³/h.  
 Accuracy: ± 5 %.

Fitted for connection of pressure ports and drain valve.

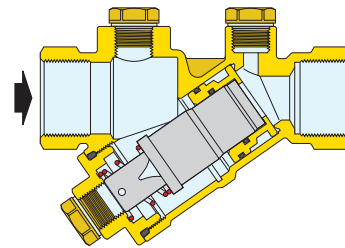

Code			
125141 ●●●	1/2"	1	–
125151 ●●●	3/4"	1	–
125161 ●●●	1"	1	–
125171 ●●●	1 1/4"	1	–
125181 ●●●	1 1/2"	1	–
125191 ●●●	2"	1	–
125101 ●●●	2 1/2"	1	–

Code	Kv (m³/h)	Min. working Δp (kPa)	Δp range (kPa)	Flow rates (m³/h)
125141 ●●●	6,69	10	10–95	0,3; 0,45; 0,5; 0,6; 0,7; 0,8; 0,9; 1,0
125151 ●●●	7,58	10	10–95	0,3; 0,45; 0,5; 0,6; 0,7; 0,8; 0,9; 1,0
125161 ●●●	13,42	10	10–95	0,7; 0,8; 0,9; 1,0
125171 ●●●	13,26	10	10–95	0,7; 0,8; 0,9; 1,0
125181 ●●●	34,72	10	10–95	2,75; 3,0; 3,25; 3,5; 3,75; 4,25; 5,0; 7,0;
125191 ●●●	37,38	10	10–95	2,75; 3,0; 3,25; 3,5; 3,75; 4,25; 5,0; 7,0;

Code	Kv (m³/h)	Min. working Δp (kPa)	Δp range (kPa)	Flow rates (m³/h)
125141 ●●●	6,69	22	22–210	0,12; 0,15; 0,2; 0,25; 0,35; 0,4; 0,6; 0,7; 0,8; 0,9; 1,2; 1,4; 1,6; 1,8
125151 ●●●	7,58	22	22–210	0,12; 0,15; 0,2; 0,25; 0,35; 0,4; 0,6; 0,7; 0,8; 0,9; 1,2; 1,4; 1,6; 1,8
125161 ●●●	13,42	22	22–210	1,0; 1,2; 1,4; 1,6; 1,8; 2,0; 2,25; 2,5; 2,75; 3,0; 3,25; 3,5; 3,75; 4,0; 4,25
125171 ●●●	13,26	22	22–210	1,0; 1,2; 1,4; 1,6; 1,8; 2,0; 2,25; 2,5; 2,75; 3,0; 3,25; 3,5; 3,75; 4,0; 4,25
125181 ●●●	34,72	22	22–210	4,0; 4,5; 5,5; 6,0; 6,5; 7,5; 8,0; 8,5; 9,0; 9,5; 10,0; 11,0
125191 ●●●	37,38	22	22–210	4,0; 4,5; 5,5; 6,0; 6,5; 7,5; 8,0; 8,5; 9,0; 9,5; 10,0; 11,0
125101 ●●●	75,82	22	22–210	9,0; 9,5; 10,0; 11,0; 12,0; 13,5; 14,5; 15,5; 16,5; 17,0

Code	Kv (m³/h)	Min. working Δp (kPa)	Δp range (kPa)	Flow rates (m³/h)
125141 ●●●	6,69	40	40–390	0,25; 0,35; 0,45; 0,7; 0,9; 1,1; 1,4; 1,6; 1,8; 2,1; 2,25; 2,5; 2,75
125151 ●●●	7,58	40	40–390	0,25; 0,35; 0,45; 0,7; 0,9; 1,1; 1,4; 1,6; 1,8; 2,1; 2,25; 2,5; 2,75
125161 ●●●	13,42	40	40–390	2,5; 2,75; 3,0; 3,25; 3,5; 3,75; 4,0; 4,25; 4,5; 5,0; 5,5; 6,0
125171 ●●●	13,26	40	40–390	2,5; 2,75; 3,0; 3,25; 3,5; 3,75; 4,0; 4,25; 4,5; 5,0; 5,5; 6,0
125181 ●●●	34,72	40	40–390	3,0; 3,25; 3,5; 3,75; 4,0; 4,25; 4,5; 6,5; 7,0; 7,5; 8,0; 8,5; 9,0; 10,0; 11,0; 12,0; 13,0; 14,5; 15,5
125191 ●●●	37,38	40	40–390	3,0; 3,25; 3,5; 3,75; 4,0; 4,25; 4,5; 6,5; 7,0; 7,5; 8,0; 8,5; 9,0; 10,0; 11,0; 12,0; 13,0; 14,5; 15,5
125101 ●●●	75,82	40	40–390	6,5; 7,0; 7,5; 8,0; 8,5; 9,0; 11,0; 18,0; 19,0; 20,0; 21,0; 22,0;

●●● For code completion see method of coding on page 257

#### Minimum differential pressure required

This is given by the sum of two values:

1. the minimum working Δp of the AUTOFLOW® cartridge;
2. the Δp required for the nominal flow rate to pass through the valve body. This value can be determined on the basis of the values of Kv shown above referring to the valve body.

$$\text{Pump head } H = \Delta p_{\text{circuit}} + \Delta p_{\text{require}}$$

## Method of coding AUTOFLOW® 120 - 125 series

For correct identification of the device, fill in the form indicating: series, size, flow rate and Δp range.

Complete code

1 <sup>st</sup>	2 <sup>nd</sup>	3 <sup>rd</sup>	4 <sup>th</sup> <b>1</b>	5 <sup>th</sup>	6 <sup>th</sup> <b>1</b>	7 <sup>th</sup>	8 <sup>th</sup>	9 <sup>th</sup>
SERIES			SIZE	FLOW RATE AND Δp RANGE				

### SERIES

1<sup>st</sup> 2<sup>nd</sup> 3<sup>rd</sup> The first three digits indicate the series:

120	AUTOFLOW® regulator and ball valve
125	AUTOFLOW® regulator

### SIZE

5<sup>th</sup> The fifth digit indicates the size:

Size	1/2"	3/4"	1"	1 1/4"	1 1/2"	2"	2 1/2"
Digit	4	5	6	7	8	9	0

### FLOW RATE AND Δp RANGE

7<sup>th</sup> 8<sup>th</sup> 9<sup>th</sup> The last three digits indicate the available flow rates.

Δp range 10–95 kPa					
m³/h	digit	m³/h	digit	m³/h	digit
0,30	S30	0,70	S70	2,75	2S7
0,45	S45	0,80	S80	3,00	3S0
0,50	S50	0,90	S90	3,25	3S2
0,60	S60	1,00	1S0	3,50	3S5
				3,75	3S7
				4,25	4S2
				5,00	5S0
				7,00	7S0

Δp range 22–210 kPa							
m³/h	digit	m³/h	digit	m³/h	digit	m³/h	digit
0,12	L12	0,70	L70	1,80	1L8	3,50	3L5
0,15	L15	0,80	L80	2,00	2L0	6,50	6L5
0,20	L20	0,90	L90	2,25	2L2	7,50	7L5
0,25	L25	1,00	1L0	2,50	2L5	8,00	8L0
0,35	L35	1,20	1L2	2,75	2L7	8,50	8L5
0,40	L40	1,40	1L4	3,00	3L0	9,00	9L0
0,60	L60	1,60	1L6	3,25	3L2	9,50	9L5
				3,50	3L5	10,0	10L
				4,00	4L0	11,0	11L
				4,25	4L2	12,0	12L
				4,50	4L5	13,5	13L
				5,00	5L0	14,5	14L
				5,50	5L5	15,5	15L
				6,00	6L0	16,5	16L
				6,50	6L5	17,0	17L

Δp range 40–390 kPa									
m³/h	digit	m³/h	digit	m³/h	digit	m³/h	digit	m³/h	digit
0,25	H25	1,40	1H4	2,75	2H7	4,25	4H2	7,00	7H0
0,35	H35	1,60	1H6	3,00	3H0	4,50	4H5	7,50	7H5
0,45	H45	1,80	1H8	3,25	3H2	5,00	5H0	8,00	8H0
0,70	H70	2,10	2H1	3,50	3H5	5,50	5H5	8,50	8H5
0,90	H90	2,25	2H2	3,75	3H7	6,00	6H0	9,00	9H0
1,10	1H1	2,50	2H5	4,00	4H0	6,50	6H5	9,50	9H5
						7,00	7H0	10,0	10H
						7,50	7H5	11,0	11H
						8,00	8H0	12,0	12H
						8,50	8H5	13,0	13H
						9,00	9H0	14,5	14H
						9,50	9H5	15,5	15H
						10,0	10H	16,5	16H
						10,0	10H	18,0	18H
								19,0	19H
								20,0	20H
								21,0	21H
								22,0	22H

SPARE STAINLESS STEEL CARTRIDGES



Spare AUTOFLOW® cartridge complete with metal tag and metal chain for fixing to the body of the AUTOFLOW® device.  
Available in different models depending on the flow rate.  
The different colours identify the available models.

**NOTE:** When ordering, give the full code of the AUTOFLOW® device into which the cartridge is to be fitted (code shown on the metal plate supplied with every AUTOFLOW® device).

**Δp range  
10–95 kPa**

For 1/2" - 3/4" bodies		For 1" bodies	
Code	Flow rate (m³/h)	Code	Flow rate (m³/h)
03S30 XXX	0,30	04S70 XXF	0,70
03S45 XXX	0,45	04S80 XXF	0,80
03S50 XXX	0,50	04S90 XXF	0,90
03S60 XXX	0,60	041S0 XXF	1,00
03S70 XXX	0,70		
03S80 XXX	0,80		
03S90 XXX	0,90		
031S0 XXX	1,00		

For 1 1/2" - 2" bodies

Code	Flow rate (m³/h)
052S7 XXX	2,75
053S0 XXX	3,00
053S2 XXX	3,25
053S5 XXX	3,50
053S7 XXX	3,75
054S2 XXX	4,25
055S0 XXX	5,00
057S0 XXX	7,00

**Δp range  
22–210 kPa**

For 1/2" - 3/4" bodies		For 1" - 1 1/4" bodies	
Code	Flow rate (m³/h)	Code	Flow rate (m³/h)
03L12 XXX	0,12	041L0 XXF	1,00
03L15 XXX	0,15	041L2 XXF	1,20
03L20 XXX	0,20	041L4 XXF	1,40
03L25 XXX	0,25	041L6 XXF	1,60
03L35 XXX	0,35	041L8 XXF	1,80
03L40 XXX	0,40	042L0 XXF	2,00
03L60 XXX	0,60	042L2 XXF	2,25
03L70 XXX	0,70	042L5 XXF	2,50
03L80 XXX	0,80	042L7 XXF	2,75
03L90 XXX	0,90	043L0 XXF	3,00
031L2 XXX	1,20	043L2 XXF	3,25
031L4 XXX	1,40	043L5 XXF	3,50
031L6 XXX	1,60	043L7 XXF	3,75
031L8 XXX	1,80	044L0 XXF	4,00
		044L2 XXF	4,25

For 1 1/2" - 2" bodies

Code	Flow rate (m³/h)
054L0 XXX	4,00
054L5 XXX	4,50
055L5 XXX	5,50
056L0 XXX	6,00
056L5 XXX	6,50
057L5 XXX	7,50
058L0 XXX	8,00
058L5 XXX	8,50
059L0 XXX	9,00
059L5 XXX	9,50
0510L XXX	10,00
0511L XXX	11,00

For 2 1/2" bodies

Code	Flow rate (m³/h)
069L0 XXF	9,00
069L5 XXF	9,50
0610L XXF	10,00
0611L XXF	11,00
0612L XXF	12,00
0613L XXF	13,00
0614L XXF	14,00
0615L XXF	15,00
0616L XXF	16,00
0617L XXF	17,00

**Δp range  
40–390 kPa**

For 1/2" - 3/4" bodies		For 1" - 1 1/4" bodies	
Code	Flow rate (m³/h)	Code	Flow rate (m³/h)
03H25 XXX	0,25	042H5 XXF	2,50
03H35 XXX	0,35	042H7 XXF	2,75
03H45 XXX	0,45	043H0 XXF	3,00
03H70 XXX	0,70	043H2 XXF	3,25
03H90 XXX	0,90	043H5 XXF	3,50
031H1 XXX	1,10	043H7 XXF	3,75
031H4 XXX	1,40	044H0 XXF	4,00
031H6 XXX	1,60	044H2 XXF	4,25
031H8 XXX	1,80	044H5 XXF	4,50
032H2 XXX	2,25	045H0 XXF	5,00
032H5 XXX	2,50	045H5 XXF	5,50
032H7 XXX	2,75	046H0 XXF	6,00

For 1 1/2" - 2" bodies

Code	Flow rate (m³/h)
043H0 XXX	3,00
043H2 XXX	3,25
043H5 XXX	3,50
043H7 XXX	3,75
044H0 XXX	4,00
044H2 XXX	4,25
044H5 XXX	4,50
056H5 XXX	6,50
057H0 XXX	7,00
057H5 XXX	7,50
058H0 XXX	8,00
058H5 XXX	8,50
059H0 XXX	9,00
0510H XXX	10,00
0511H XXX	11,00
0512H XXX	12,00
0513H XXX	13,00
0514H XXX	14,50
0515H XXX	15,50

For 2 1/2" bodies

Code	Flow rate (m³/h)
066H5 XXX	6,50
067H0 XXX	7,00
057H5 XXX	7,50
058H0 XXX	8,00
058H5 XXX	8,50
059H0 XXX	9,00
0511H XXX	11,00

**AUTOMATIC FLOW REGULATOR WITH STAINLESS STEEL CARTRIDGE**

**103 AUTOFLOW®**

tech. broch. 01041

Automatic flow rate regulator, flanged version.  
 Cast iron body. Stainless steel AUTOFLOW® cartridge.  
 Max. working pressure: 16 bar.  
 Temperature range: -20–110°C.  
 Max. percentage of glycol: 50 %.  
 Δp range: 22–210 kPa; 40–390 kPa; 55–210 kPa.  
 Flow rates: 9–4400 m³/h.  
 Accuracy: ± 5 %.

Supplied with flat counterflanges EN 1092-1 PN 16, rods, gasket and quick-fit pressure test ports.

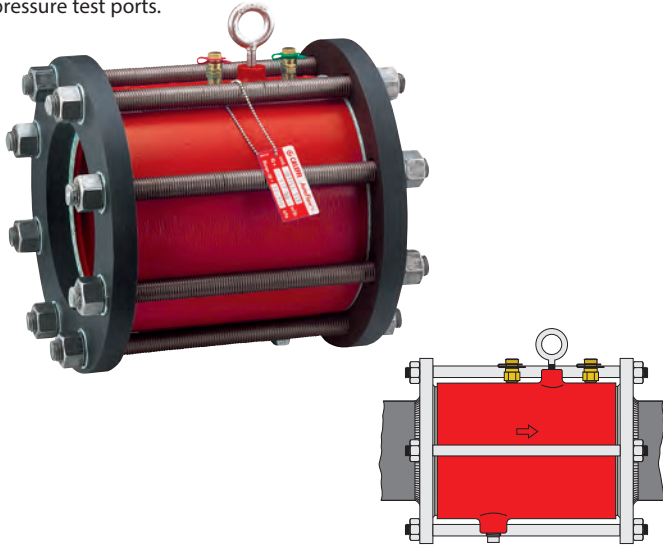

**Minimum differential pressure required**

This is equal to the min. working Δp of the AUTOFLOW® cartridge (22, 40 or 55 kPa).  
 Pump head  $H = \Delta p_{\text{circuit}} + \Delta p_{\text{require}}$

Code	DN	Min. working (kPa)	Flow rates (m³/h)	Δp range (kPa)		
103111 ●●●	65	22	9– 17	22–210	1	–
103113 ●●●	65	40	18– 23	40–390	1	–
103114 ●●●	65	55	25– 36	55–210	1	–
103121 ●●●	80	22	9– 17	22–210	1	–
103123 ●●●	80	40	18– 23	40–390	1	–
103124 ●●●	80	55	25– 36	55–210	1	–
103231 ●●●	100**	22	18– 34	22–210	1	–
103233 ●●●	100**	40	23– 45	40–390	1	–
103234 ●●●	100**	55	50– 73	55–210	1	–
103141 ●●●	125	22	18– 34	22–210	1	–
103143 ●●●	125	40	23– 45	40–390	1	–
103144 ●●●	125	55	50– 73	55–210	1	–
103151 ●●●	150	22	40– 68	22–210	1	–
103153 ●●●	150	40	40– 91	40–390	1	–
103154 ●●●	150	55	92–145	55–210	1	–
103161 ●●●	200*	22	80–119	22–210	1	–
103163 ●●●	200*	40	80–159	40–390	1	–
103164 ●●●	200*	55	160–255	55–210	1	–
103171 ●●●	250*	22	110–187	22–210	1	–
103173 ●●●	250*	40	110–250	40–390	1	–
103174 ●●●	250*	55	251–400	55–210	1	–
103181 ●●●	300*	22	150–255	22–210	1	–
103183 ●●●	300*	40	150–341	40–390	1	–
103184 ●●●	300*	55	342–545	55–210	1	–

\* Supplied with ANSI 150 flanges.

\*\* Supplied with flanges EN 1092-1 PN 25.

They are available on request in sizes DN 350 to DN 1000, with flow rates up to 4400 m³/h.

To identify AUTOFLOW® devices and their codes correctly, contact Caleffi technical support in advance.

**Method of coding AUTOFLOW® 103 series**

To identify AUTOFLOW® devices and their codes correctly, contact Caleffi technical support in advance.

For correct identification of the device, fill in the form indicating: size, Δp range and the flow rate.

Complete code

1 <sup>st</sup>	2 <sup>nd</sup>	3 <sup>rd</sup>	4 <sup>th</sup>	5 <sup>th</sup>	6 <sup>th</sup>	7 <sup>th</sup>	8 <sup>th</sup>	9 <sup>th</sup>
1	0	3	1					
Series			(*)	SIZE	Δp RANGE	FLOW RATE		

(\*) 4<sup>th</sup> for codes 103231, 103233, 103234

DN	100
Digit	2

SIZE 5<sup>th</sup> The fifth figure indicates the size:

DN	65	80	100	125	150	200	250	300
Digit	1	2	3	4	5	6	7	8

Δp RANGE 6<sup>th</sup> The sixth figure indicates the differential pressure range (Δp range):

kPa	22–210	40–390	55–210
Digit	1	3	4

FLOW RATE 7<sup>th</sup> 8<sup>th</sup> 9<sup>th</sup> The last three digits indicate the flow rate values.



## DIFFERENTIAL PRESSURE CONTROL DEVICES

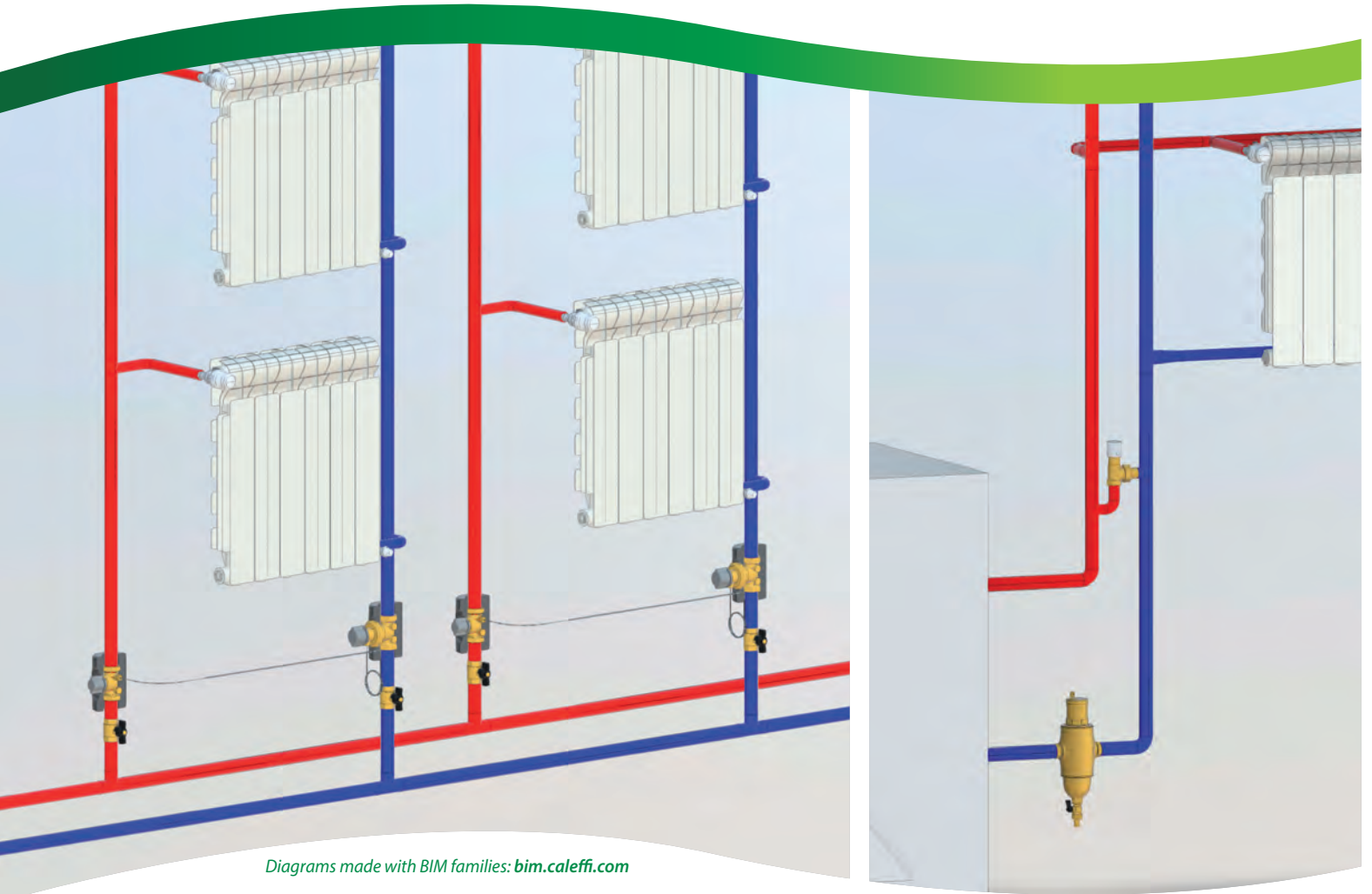

*Diagrams made with BIM families: [bim.caleffi.com](http://bim.caleffi.com)*

**Differential pressure control valve**  
**Differential by-pass valve**  
**Measuring and control accessories**

DIFFERENTIAL PRESSURE CONTROL VALVE (DPCV)





140

tech. broch. 01250

Differential pressure control valve (DPCV).  
 CR dezincification resistant alloy body.  
 Complete with capillary pipe for connection to the valve on the flow pipe.  
**With insulation.**  
 Max. working pressure: 16 bar.  
 Temperature range: -10–120 °C.  
 Max. percentage of glycol: 50 %.  
 Length of capillary pipe Ø 3 mm: 1,5 m.



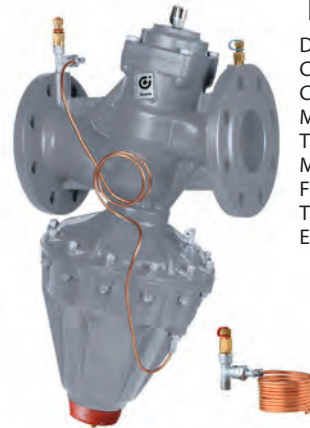

Code	Differential pressure adjustable set (mbar)			
140340	1/2" 50–300		1	5
140440	1/2" 250–600		1	5
140350	3/4" 50–300		1	5
140450	3/4" 250–600		1	5
140360	1" 50–300		1	5
140460	1" 250–600		1	5
140342	1/2" 50–300 without insulation		1	5
140442	1/2" 250–600 without insulation		1	5
140352	3/4" 50–300 without insulation		1	5
140452	3/4" 250–600 without insulation		1	5
140362	1" 50–300 without insulation		1	5
140462	1" 250–600 without insulation		1	5



140

Differential pressure control valve (DPCV).  
 Cast iron body.  
 Complete with pressure ports.  
 Max. working pressure: 16 bar.  
 Temperature range: -10–120 °C.  
 Max. percentage of glycol: 50 %.  
 Flanged connections PN 16.  
 To be coupled with flat counterflanges EN 1092-1.

Code	Differential pressure adjustable set (mbar)			
140506	DN 65 200–800		1	–
140606	DN 65 800–1600		1	–
140508	DN 80 200–800		1	–
140608	DN 80 800–1600		1	–
140510	DN 100 200–800		1	–
140610	DN 100 800–1600		1	–
140512	DN 125 200–800		1	–
140515	DN 150 200–800		1	–





140

tech. broch. 01250

Differential pressure control valve (DPCV).  
 CR dezincification resistant alloy body.  
 Complete with capillary pipe for connection to the valve on the flow pipe.  
**With insulation.**  
 Max. working pressure: 10 bar.  
 Temperature range: -10–120 °C.  
 Max. percentage of glycol: 50 %.  
 Length of capillary pipe Ø 3 mm: 1,5 m.





Code	Differential pressure adjustable set (mbar)			
140370	1 1/4" 50–300		1	–
140470	1 1/4" 250–600		1	–
140380	1 1/2" 50–300		1	–
140480	1 1/2" 250–600		1	–
140372	1 1/4" 50–300 without insulation		1	–
140472	1 1/4" 250–600 without insulation		1	–
140382	1 1/2" 50–300 without insulation		1	–
140482	1 1/2" 250–600 without insulation		1	–
140392	2" 50–300 without insulation		1	–
140492	2" 250–600 without insulation		1	–



142

tech. broch. 01250

Shut-off and pre-regulation valve.  
 CR dezincification resistant alloy body.  
 Complete with pressure test ports for connection of capillary pipe.  
**With insulation.**  
 Max. working pressure: 16 bar.  
 Temperature range: -10–120 °C.  
 Max. percentage of glycol: 50 %.



Code				
142140	1/2"		1	5
142150	3/4"		1	5
142160	1"		1	10
142240	1/2" without insulation		1	10
142250	3/4" without insulation		1	10
142260	1" without insulation		1	10



142

tech. broch. 01250

Shut-off and pre-regulation valve.  
 CR dezincification resistant alloy body.  
 Complete with pressure test ports for connection of capillary pipe.  
**With insulation.**  
 Max. working pressure: 16 bar.  
 Temperature range: -10–120 °C.  
 Max. percentage of glycol: 50 %.

Code				
142170	1 1/4"		1	–
142180	1 1/2"		1	–
142270	1 1/4" without insulation		1	5
142280	1 1/2" without insulation		1	5
142290	2" without insulation		1	–



DIFFERENTIAL BY-PASS VALVES



519

tech. broch. 01007

Differential by-pass valve, adjustable with graduated scale. Max. working pressure: 10 bar. Temperature range: 0–110 °C. Max. percentage of glycol: 30 %.



Threaded connections

Code		Setting range m w.g.		
519500	3/4"	1–6	1	50
519504	3/4"	10–40	1	50
519700	1 1/4"	1–6	1	10
519703	1 1/4"	5–25	1	10

Compression ends

Code		Setting range m w.g.		
519002	Ø 22	1–6	1	50



518

tech. broch. 01007

Differential by-pass valve, adjustable with graduated scale. Max. working pressure: 10 bar. Temperature range: 0–100 °C. Max. percentage of glycol: 30 %.

Code		Setting range m w.g.		
518015	3/4"	1–6	1	25



518

tech. broch. 1410

Differential by-pass valve, adjustable with graduated scale. Max. working pressure: 10 bar. Temperature range: 0–100 °C. Max. percentage of glycol: 30 %.

Threaded connections

Code		Setting range m w.g.		
518500	3/4"	1–6	1	50

Compression ends

Code		Setting range m w.g.		
518002	Ø 22	1–6	1	50

MEASURING STATION

130

tech. broch. 01251

Electronic flow rate and differential pressure measuring station. Supplied complete with shut-off and connection fittings. Can be used for measuring the flow rate of balancing valves 130, 142 series and of the flow metering device 683 series. Suitable for  $\Delta p$  measurement of automatic flow rate regulators. Electric supply from battery. Bluetooth® transmission between  $\Delta p$  measuring station and remote control unit. Versions complete with remote control unit with Android® application for Smartphone and Tablet. Measurement range: 0–1000 kPa. Static Pmax: 1000 kPa.



Smart Balancing Caleffi  
Available app for smartphone.  
Download for your Android® mobile phone.

Code			
130006	complete with remote control unit, with Android® application	1	–
130005	without remote control unit, with Android® application	1	–

Transmission via Bluetooth® to the terminal with Android® application

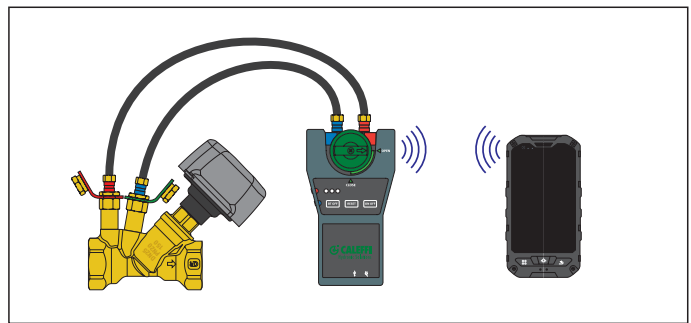

Transmission via Bluetooth® to Smartphone/Tablet with Android® application

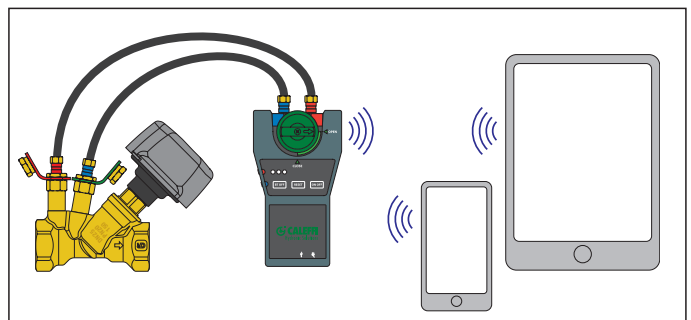

MEASURING AND CONTROL ACCESSORIES



100

tech. broch. 01041

Pair of fast-plug pressure/temperature test ports. Their special construction allows rapid and accurate measurements while ensuring leaktightness.

Can be used for:

- checking the working range of AUTOFLOW®;
- checking the clog degree of strainers;
- checking the heat output of the terminals.

Cap cover facing available in:

- - **Red** for upstream pressure test port.
- - **Green** for downstream pressure test port.

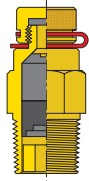

Brass body.  
EPDM seals.  
Max. working pressure: 30 bar.  
Temperature range: -5-130 °C.

Code

100000 1/4"



1 100



538

tech. broch. 01041

Drain cock with hose connection and cap.  
Max. working pressure: 10 bar.  
Max. working temperature: 110 °C.



Code

538201 1/4" M



1 -

538400 1/2" M

1 100



140

Tee for pressure test ports.

Code

140002 1/4"



1 -



538

Manual shut-off cock.  
Brass body.  
Seals in non-asbestos fibre.  
Max. working pressure: 16 bar.  
Temperature range: -10-120 °C.

Code

538203 1/4"



1 -



100

tech. broch. 01041

Pair of fittings with fast-plug syringe for connection of pressure ports to measuring instruments.  
1/4" female threaded connection.  
Max. working pressure: 10 bar.  
Max. working temperature: 110 °C.

Code

100010 1/4"



1 -

# REGULATING VALVES

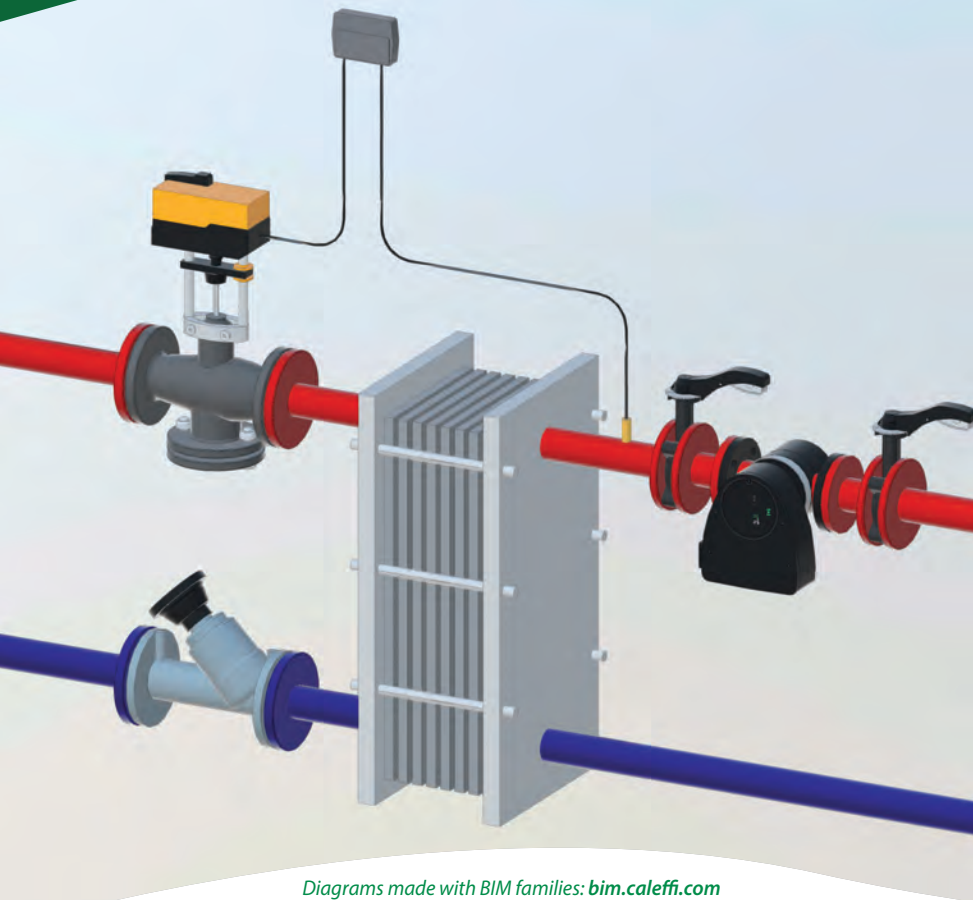

Diagrams made with BIM families: [bim.caleffi.com](http://bim.caleffi.com)

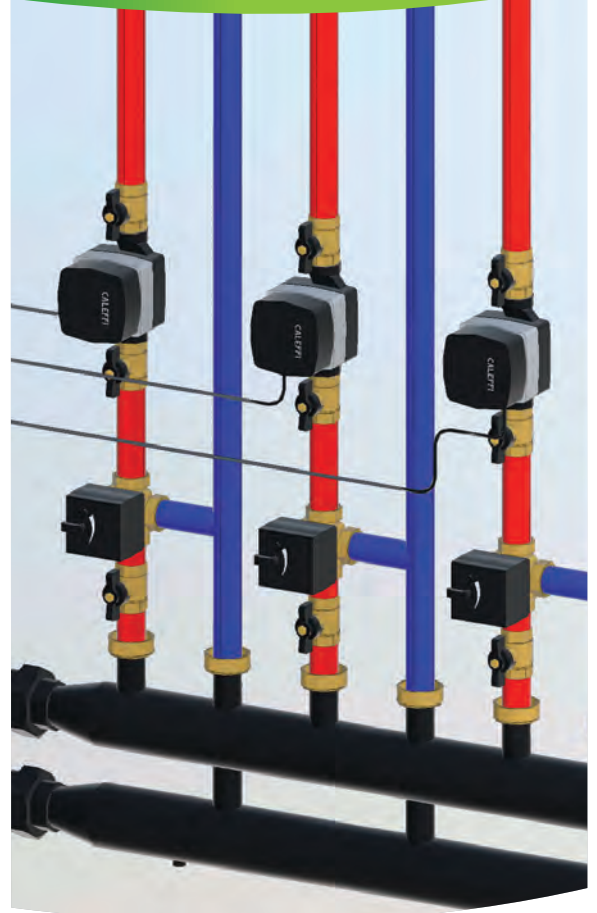

- Regulating valves**
- Butterfly valve**
- Mixing valves**
- Actuators for mixing valves**
- Motorised mixing valves**
- Actuators**
- Temperature regulators**

REGULATING VALVES



636

tech. broch. 01354

Two-way regulating globe valve, threaded. Female union connections. **CR** dezincification resistant alloy body. PN 16. Equipercantage regulation. Max. working pressure: 16 bar. Temperature range: 0–100 °C.

Code	DN	Conn.	Kv (m <sup>3</sup> /h)		
636400	15	1/2"	4	1	–
636500	20	3/4"	6,3	1	–
636600	25	1"	10	1	–
636700	32	1 1/4"	16	1	–
636800	40	1 1/2"	22	1	–
636900	50	2"	28	1	–

Application diagram of threaded two-way regulating valve

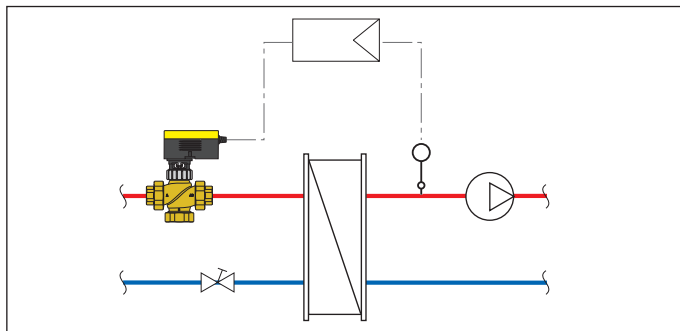

636

tech. broch. 01354

Three-way regulating globe valve, threaded. Female union connections. **CR** dezincification resistant alloy body. PN 16. Equipercantage/linear regulation. Max. working pressure: 16 bar. Temperature range: 0–100 °C.

Code	DN	Conn.	Kv (m <sup>3</sup> /h)		
636410	15	1/2"	4	1	–
636510	20	3/4"	6,3	1	–
636610	25	1"	10	1	–
636710	32	1 1/4"	16	1	–
636810	40	1 1/2"	22	1	–
636910	50	2"	28	1	–

Application diagram of threaded three-way regulating valve

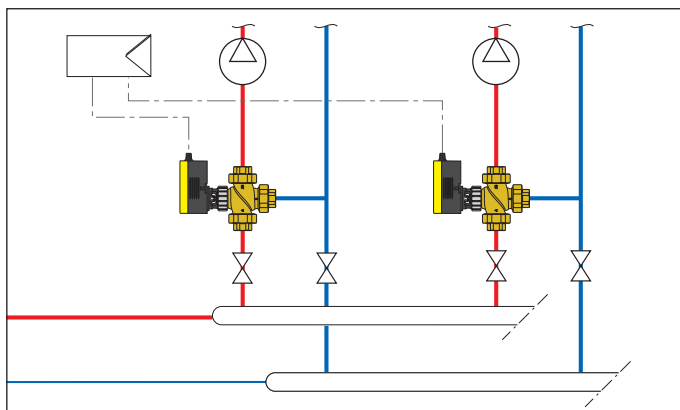

636

tech. broch. 01354

Actuator for threaded regulating valves 636 series. Supply: **24 V**. Control signal: **2 points, 3 points, 0–10 V**. Power consumption: 8,5 VA. Protection class: IP 54. Operating time: 35 s, 60 s, 120 s. Ambient temperature range: -10–55 °C.



Code	Tension V	Nominal force (N)		
636004	24	250	1	–



636

tech. broch. 01354

Actuator for threaded regulating valves 636 series. Supply: **230 V**. Control signal: **2 points, 3 points**. Power consumption: 4 VA. Protection class: IP 54. Operating time: 120 s. Ambient temperature range: -10–55 °C.



Code	Tension V	Nominal force (N)		
636002	230	500	1	–



636

tech. broch. 01354

Actuator for threaded regulating valves 636 series. Supply: **24 V**. Control signal: **2 points, 3 points, 0–10 V**. Power consumption: 8,7 VA. Protection class: IP 54. Operating time: 60 s, 120 s. Ambient temperature range: -10–55 °C.



Code	Tension V	Nominal force (N)		
636014	24	500	1	–

Max. Δp table: actuator + threaded valve body 636 series

Code body valve	Actuator code 636004	Actuator code 636002	Actuator code 636014
6364.0	4 bar	6 bar	6 bar
6365.0	4 bar	5 bar	5 bar
6366.0	4 bar	4 bar	4 bar
6367.0	3 bar	3,5 bar	3,5 bar
6368.0	1,9 bar	3 bar	3 bar
6369.0	1 bar	2,4 bar	2,4 bar

REGULATING VALVES



636

tech. broch. 01354

Two/three-way regulating globe valve, flanged.  
 Grey cast iron body.  
 Flanged connections. PN 16.  
 To be coupled with flat counterflanges EN 1092-1.  
 Equipercantage regulation (two-way).  
 Equipercantage/linear regulation (three-way).  
 Max. working pressure: 16 bar.  
 Temperature range: 0–100 °C.  
**The valve can be transformed into a three-way valve by opening the central third port.**

Code		Kv (m <sup>3</sup> /h)		
636060	DN 65	63	1	-
636080	DN 80	100	1	-
636100	DN 100	160	1	-
636120	DN 125	220	1	-
636150	DN 150	320	1	-

Application diagram of flanged two-way regulating valve

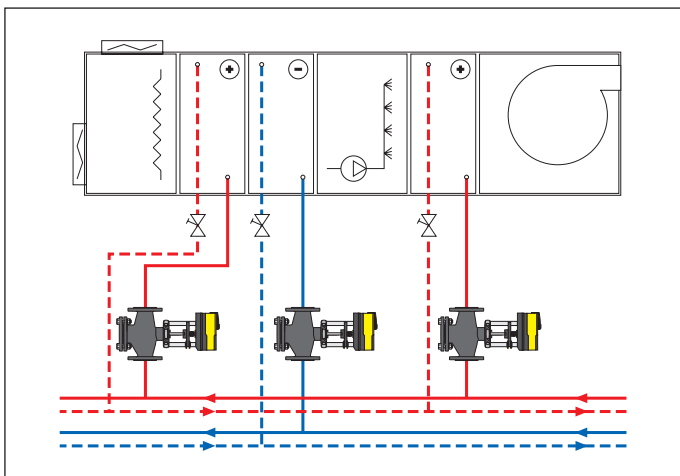

Application diagram of flanged three-way regulating valve

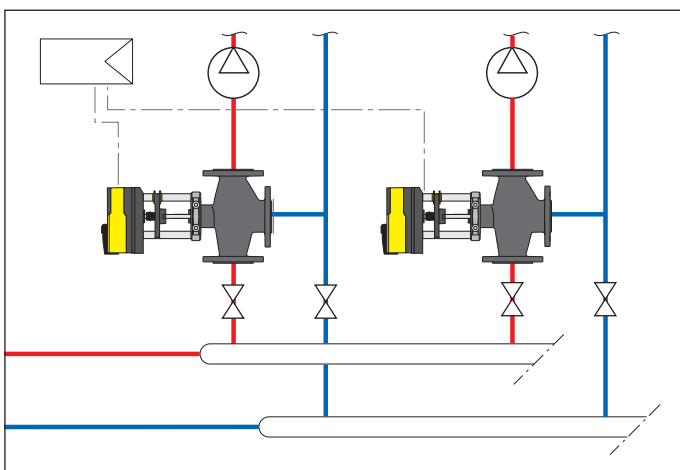

636

tech. broch. 01354

Actuator for flanged regulating valves 636 series. codes 636060 and 636080.  
 Supply: **24 V**.  
 Control signal: **2 points, 3 points, 0–10 V**.  
 Power consumption: 3,5 VA.  
 Protection class: IP 54.  
 Operating time: 80 s / 120 s.  
 Ambient temperature range: -10–55 °C.



Code	Tension V	Nominal force (N)		
636024	24	1.000	1	-



636

tech. broch. 01354

Actuator for flanged regulating valves 636 series.  
 Supply: **24 V**.  
 Control signal: **2 points, 3 points, 0–10 V**.  
 Power consumption: 20 VA.  
 Protection class: IP 66.  
 Operating time:  
 40 s / 80 s / 120 s (DN 65–DN 80),  
 80 s / 160 s / 240 s (DN 100–DN 150).  
 Ambient temperature range: -10–55 °C.



Code	Tension V	Nominal force (N)		
636034	24	2.500	1	-

Max. Δp table: actuator + flanged valve body 636 series

Code body valve	Actuator code 636024	Actuator code 636034
636060	2,5 bar	3 bar
636080	1,5 bar	3 bar
636100	-	2 bar
636125	-	1,5 bar
636150	-	1 bar

BUTTERFLY VALVE



639

tech. broch. 01380

Butterfly valve, LUG type.  
Grey cast iron body.  
Flanged connections. PN 10/16.  
To be coupled with flat counterflanges  
PN 10/16 - EN 1092-1.  
Max. working pressure: 16 bar.  
Working temperature range: -20–120 °C.



639

tech. broch. 01380

Butterfly valve, WAFER type.  
Grey cast iron body.  
Flanged connections. PN 6/10/16.  
To be coupled with flat counterflanges  
PN 6/10/16 - EN 1092-1.  
Max. working pressure: 16 bar.  
Working temperature range: -20–120 °C.

Code		Kv (m³/h)		
639040	DN 40	65	1	-
639050	DN 50	100	1	-
639060	DN 65	170	1	-
639080	DN 80	260	1	-
639100	DN 100	520	1	-
639120	DN 125	880	1	-
639150	DN 150	1400	1	-

Code		Kv (m³/h)		
639041	DN 40	65	1	-
639051	DN 50	100	1	-
639061	DN 65	170	1	-
639081	DN 80	260	1	-
639101	DN 100	520	1	-
639121	DN 125	880	1	-
639151	DN 150	1400	1	-

639

tech. broch. 01380

Actuator for butterfly valve 639 series  
DN 40 - DN 125.  
Supply: 230 V (AC) o 24 V (DC).  
Control signal: **ON/OFF, 3 points.**  
Protection class: IP 54.  
Operating time (90° rotation): 150 s.



Δp max: 3 bar.  
Δp max closure: 12 bar.  
Ambient temperature range: -30–50 °C.  
Warehouse storage temperature range:  
-40–80 °C.  
**Compatible with auxiliary microswitch  
code 639900.**

Code	Use	Voltage V		
639902	DN 40–DN 65	230	1	-
639912	DN 80	230	1	-
639922	DN 100	230	1	-
639932	DN 125	230	1	-
639904	DN 40–DN 65	24	1	-
639914	DN 80	24	1	-
639924	DN 100	24	1	-
639934	DN 125	24	1	-

639

tech. broch. 01380



Actuator for butterfly valve 639 series  
DN 150  
Supply: 230 V (AC) o 24 V (DC).  
**With auxiliary 2 microswitches.**  
Adjustable points of intervention.  
Microswitch contact rating:  
1 mA...3 (0.5) A - 250 V (AC).  
Control signal: **ON/OFF, 3 points.**  
Protection class: IP 66/67.  
Operating time (90° rotation): 30–120 s.  
Δp max: 3 bar.  
Δp max closure: 12 bar.  
Ambient temperature range: -30–50 °C.  
Warehouse storage temperature range: -40–80 °C.

Code	Use	Voltage V		
639942	DN 150	230	1	-

639

tech. broch. 01380



Auxiliary microswitches for 639 series actuators DN  
40–DN 125.  
Adjustable points of intervention.  
Microswitch contact rating:  
1 mA...3 (0.5) A - 250 V (AC),  
1 mA...0.5 (0.2) A - 110 V (DC).  
Ambient temperature range: -30–50 °C.  
Warehouse storage temperature range: -40–80 °C.

Code	Use		
639900	DN 40–DN 125	1	-



639

tech. broch. 01380

Manual lever  
for 639 series butterfly valves.

Code	Use		
639000	DN 40–DN 100	1	-
639001	DN 125–DN 150	1	-

MIXING VALVES



610

tech. broch. 01353

Three-way sector mixing valve, threaded connections. Brass body. PN 10. Max. working pressure: 10 bar. Max. Δp: 1 bar. Temperature range: 5–110 °C. **Factory configuration: boiler inlet on the RH connection.**

Code		Kv (m³/h)		
610400	Rp 1/2"	4	1	–
610500	Rp 3/4"	6,3	1	–
610600	Rp 1"	10	1	–
610700	Rp 1 1/4"	15	1	–
610800	Rp 1 1/2"	25	1	–
610900	Rp 2"	40	1	–

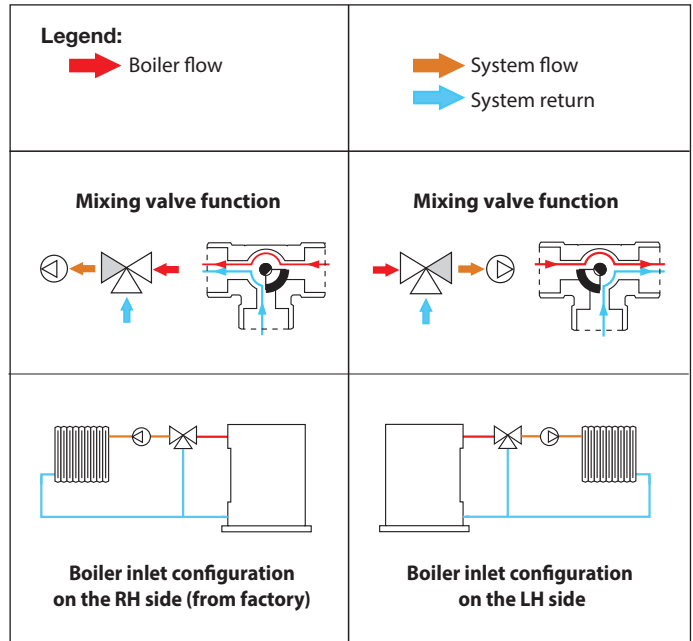
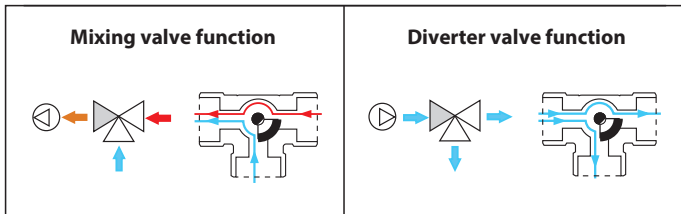

ACTUATORS FOR MIXING VALVES



6370

tech. broch. 01353

Actuator for mixing valves codes 610.00 from 1/2" to 2". Supply: 230 V - 50 Hz. Control signal: 3 points. Power consumption: 3 VA. Protection class: IP 44. Rotation 90°. Operating time: 150 s. Ambient temperature range: 0–55 °C. Storage temperature range: -10–70 °C. Supply cable length: 1,5 m.



Code	Tension V	Actuator torque (N·m)		
637042	230	5	1	–

Wiring diagram

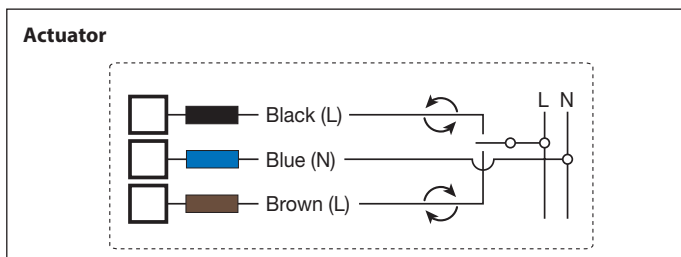

6370

tech. broch. 01353

Actuator for mixing valves codes 610.00 from 1/2" to 2". Supply: 24 V. Control signal: 0(2)–10 V, 0(4)–20 mA, 0–5 V, 5–10 V. Power consumption: 2 W. Protection class: IP 44. Rotation 90°. Operating time: 75 s. Ambient temperature range: 0–55 °C. Storage temperature range: -10–70 °C. Supply cable length: 1,5 m.



Code	Tension V	Actuator torque (N·m)		
637044	24	5	1	–

Wiring diagram

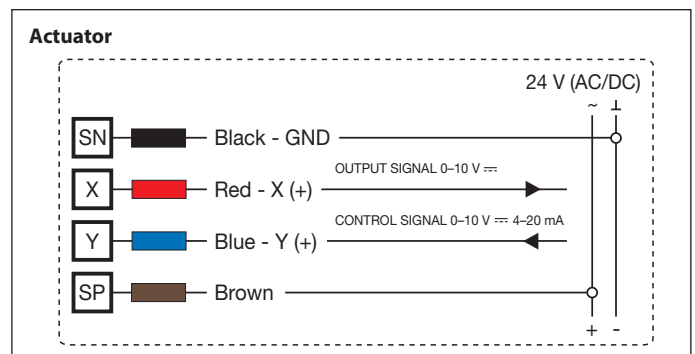

MIXING VALVES





610

tech. broch. 01169

Three-way butterfly mixing valve.  
Threaded connections.  
Max. working pressure: 6 bar.  
Temperature range: 2–110 °C.

**Factory configuration:**  
boiler inlet on the RH connection.

Code		Kv (m³/h)		
610005	3/4"	7,5	1	–
610006	1"	11,9	1	–
610007	1 1/4"	16,8	1	–
610008	1 1/2"	30	1	–
610009	2"	45	1	–
610020	2 1/2"	72	1	–





610

tech. broch. 01169

Three-way butterfly mixing valve.  
Body PN 6.  
Flanged connections.  
To be coupled with  
flat counterflanges EN 1092-1.  
Max. working pressure: 6 bar.  
Temperature range: 2–110 °C.

**Factory configuration:**  
boiler inlet on the RH connection.

Code		Kv (m³/h)		
610050	DN 50 (2")	45	1	–
610060	DN 65 (2 1/2")	72	1	–
610080	DN 80 (3")	140	1	–
610100	DN 100 (4")	183	1	–
610120	DN 125 (5")	340	1	–





611

tech. broch. 01169

Four-way butterfly mixing valve.  
Threaded connections.  
Max. working pressure: 6 bar.  
Temperature range: 2–110 °C.

**Factory configuration:**  
boiler inlet on the RH connection.

Code		Kv (m³/h)		
611005	3/4"	7,8	1	–
611006	1"	12,3	1	–
611007	1 1/4"	18,5	1	–
611008	1 1/2"	30	1	–
611009	2"	53	1	–
611020	2 1/2"	80	1	–





611

tech. broch. 01169

Four-way butterfly mixing valve.  
Body PN 6.  
Flanged connections.  
To be coupled with  
flat counterflanges EN 1092-1.  
Max. working pressure: 6 bar.  
Temperature range: 2–110 °C.

**Factory configuration:**  
boiler inlet on the RH connection.

Code		Kv (m³/h)		
611050	DN 50 (2")	53	1	–
611060	DN 65 (2 1/2")	80	1	–
611080	DN 80 (3")	140	1	–
611100	DN 100 (4")	230	1	–
611120	DN 125 (5")	410	1	–

Mixing valve - actuator coupling table

	GENERATOR INLET	VALVE OPENING	ACTUATOR
Three-way butterfly 610 series, 3/4" - 1 1/2"	Right	Counter clockwise rotation	638032
	Left	Clockwise rotation	638002
Three-way butterfly 610 series, 2" - 2 1/2" DN 50 - DN 125	Right	Counter clockwise rotation	638022
	Left	Clockwise rotation	638022
Four-way butterfly 611 series, 3/4" - 1 1/2"	Right	Counter clockwise rotation	638032
	Left	Clockwise rotation	638002
Four-way butterfly 611 series, 2" - 2 1/2" DN 50 - DN 125	Right	Counter clockwise rotation	638022
	Left	Clockwise rotation	638022
612 series sector, 3/4" - 1 1/2"	Right	Clockwise rotation	638002
	Left	Counter clockwise rotation	638032
612 series sector, 2" - 2 1/2" DN 50 - DN 125	Right	Clockwise rotation	638022
	Left	Counter clockwise rotation	638022



SECTOR MIXING VALVE

612

tech. broch. 01169

Three-way sector mixing valve. Threaded connections. Max. working pressure: 6 bar. Temperature range: 2–110 °C.

**Heavy series.**

**Factory configuration:** boiler inlet on the RH connection.

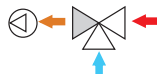

Code		Kv (m <sup>3</sup> /h)		
612005	3/4"	7,2	1	–
612006	1"	11,9	1	–
612007	1 1/4"	16,5	1	–
612008	1 1/2"	30	1	–
612009	2"	42	1	–
612020	2 1/2"	62	1	–

NEW

612

tech. broch. 01169

Three-way sector mixing valve. Threaded connections. Max. working pressure: 6 bar. Temperature range: 2–110 °C.

**Heavy series.**

**Factory configuration:** boiler inlet on the LH connection.

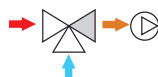

Code		Kv (m <sup>3</sup> /h)		
612035	3/4"	7,2	1	–
612036	1"	11,9	1	–
612037	1 1/4"	16,5	1	–
612038	1 1/2"	30	1	–
612039	2"	42	1	–
612031	2 1/2"	62	1	–

612

tech. broch. 01169

Three-way sector mixing valve. Body PN 6. Flanged connections. To be coupled with flat counterflanges EN 1092-1. Max. working pressure: 6 bar. Temperature range: 2–110 °C.

**Heavy series.**

**Factory configuration:** boiler inlet on the RH connection.



Code		Kv (m <sup>3</sup> /h)		
612050	DN 50 (2")	42	1	–
612060	DN 65 (2 1/2")	62	1	–
612080	DN 80 (3")	123	1	–
612100	DN 100 (4")	172	1	–
612120	DN 125 (5")	340	1	–

ACTUATORS

NEW

638

tech. broch. 01169

Actuator for mixing valves from 3/4" to 1 1/2". With auxiliary microswitch. Supply: 230 V (AC). Power consumption: 6 VA. Auxiliary microswitch contact rating: 6 (2) A - 230 V (AC). Protection class: IP 65. Operating time: 50 s (90° rotation). With adapter.



CE

Clockwise rotation

Code	Supply voltage V	Actuator torque (N·m)		
638002	230	15	1	–

NEW

638

Actuator for mixing valves from 3/4" to 1 1/2". With auxiliary microswitch. Supply: 230 V (AC). Power consumption: 6 VA. Auxiliary microswitch contact rating: 6 (2) A - 230 V (AC). Protection class: IP 65. Operating time: 50 s (90° rotation). With adapter.



CE

Counter clockwise rotation

Code	Supply voltage V	Actuator torque (N·m)		
638032	230	15	1	–

NEW

638

tech. broch. 01169

Actuator for mixing valves from 2" to 5". With double auxiliary microswitches. Supply: 230 V or 24 V - 50 Hz. Power consumption: 10 VA. Auxiliary microswitch contact rating: 6 (2) A - 230 V (AC). Protection class: IP 65. Operating time: 50 s (90° rotation). With adapter.



CE

Code	Supply voltage V	Actuator torque (N·m)		
638022	230 / 24	35	1	–

TEMPERATURE REGULATORS



161

Digital regulator with synoptic diagram for **heating and cooling** complete with immersion flow probes with pocket and Pt1000 Ø 6 mm return probe (pocket to be chosen according to the pipe, see accessories).  
Optional outside compensated probe.  
Temperature adjustment range: 5–95 °C.  
Supply: 230 V - 50/60 Hz.  
Control signal: 3-point, 0–10 V.  
Protection class: IP 20 / EN 60529.  
Probe cable length: 1,5 m.



Code

161010



1 -



161

Remote regulator.  
Functions:  
- translation of regulation curves from +15 K to -15 K  
- max. temperature  
- position OFF.

Code

161005



1 -

Accessories for regulator code 161010.

Code

- 161012 Pt1000 contact probe for pipes Ø 6 mm, cable L 2,5 m
- 161013 immersion pocket for Pt1000 probe 1/2" M, 60 mm
- 161014 immersion pocket for Pt1000 probe 1/2" M, 100 mm
- 161015 Pt1000 probe Ø 6 mm - L 20 mm, cable L 1,5 m
- 161006 Pt1000 probe Ø 6 mm - L 45 mm, cable L 2,5 m



161

Outside temperature probe.

Code

161002



1 -



1520

Digital temperature controller for **heating and cooling**.  
Complete with flow probe, outside probe and max. relative humidity probe.  
Supply: 230 V - 50/60 Hz.  
Power consumption: 5,5 VA.  
Protection class: IP 40.



Code

152021 1 channel



1 -



161

Pressure switch with preconnected pin.  
Working range: 0,5–10 bar.  
Max. working temperature: 100 °C.  
Cable length: 1 m.

Code

161003



1 -



161

Dew point detector.  
Working range: 30–100 RH %.

Code

161004



1 -



1520

Outside compensated digital temperature regulator for **heating**.  
Complete with contact flow probe and outside probe.  
Adjustment range: 20–90 °C.  
Supply: 230 V - 50/60 Hz.  
Control signal: 3-point.  
Protection class: IP 40.



Code

- 152001 1 channel
- 152002 2 channels
- 152003 3 channels



1 -  
1 -  
1 -

## FITTINGS

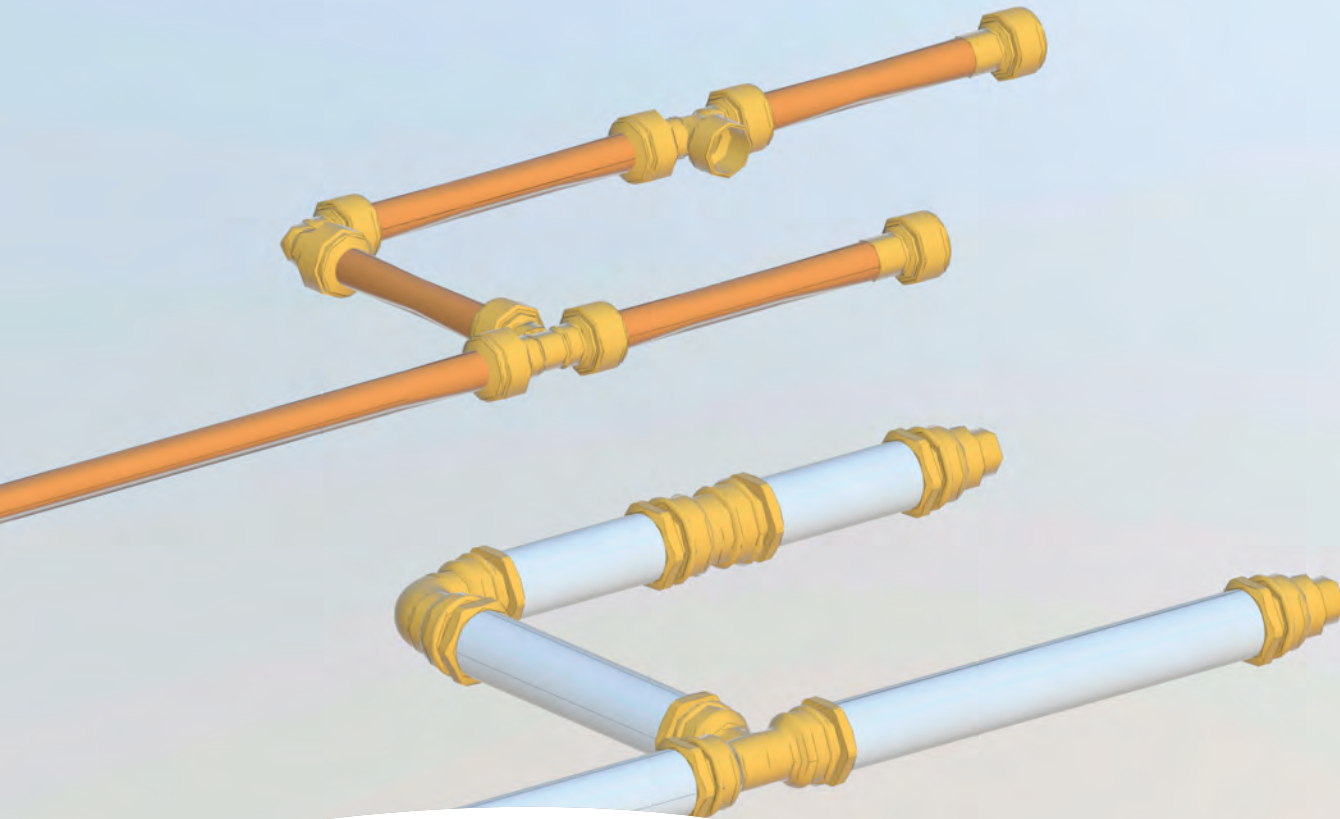

*Diagrams made with BIM families: [bim.caleffi.com](http://bim.caleffi.com)*

- Three-piece union fittings**
- Fittings for polyethylene pipes (PE-X)**
- Mechanical fittings with O-Ring seal**
- DECA-fittings for polyethylene pipes**
- Dezincification resistant alloy fittings for polyethylene pipes**
- DECA-fittings for steel pipes**

THREE-PIECE UNION FITTINGS

**for gas and hydrocarbons - EN 549 standard**

**for hydraulic and domestic water systems - EN 681.1 standard**

Fittings highlighted in yellow are supplied with two O-Rings: yellow to be used for gas and fluid hydrocarbons - black to be used for hydraulic systems.

To be used for gas systems with power output up to 35 kW, according to UNI 7129-2015 standard only.



**588**

Three-piece straight union fitting. PN 16.  
**For gas and fluid hydrocarbons:**  
 yellow O-Ring according to EN 549 standard.  
 Temperature range: -20–100 °C.  
**For hydraulic and domestic water systems:**  
 black O-Ring according to EN 681.1 standard.  
 Max. working pressure: 16 bar.  
 Temperature range: -25–120 °C.



**5881**

Three-piece elbow union fitting. PN 16.  
**For gas and fluid hydrocarbons:**  
 yellow O-Ring according to EN 549 standard.  
 Temperature range: -20–100 °C.  
**For hydraulic and domestic water systems:**  
 black O-Ring according to EN 681.1 standard.  
 Max. working pressure: 16 bar.  
 Temperature range: -25–120 °C.

Code				
588030	3/8" F	x M with union	1	50
588040	1/2" F	x M with union	1	50
588050	3/4" F	x M with union	1	25
588060	1" F	x M with union	1	20
588070	1 1/4" F	x M with union	1	10
588080	1 1/2" F	x M with union	1	-
588090	2" F	x M with union	1	-

Code				
588130	3/8" F	x M with union	1	50
588140	1/2" F	x M with union	1	25
588150	3/4" F	x M with union	1	25
588160	1" F	x M with union	1	15
588170	1 1/4" F	x M with union	1	10



**588**

Three-piece straight union fitting. PN 16.  
 Chrome plated.  
**For hydraulic and domestic water systems:**  
 black O-Ring according to EN 681.1 standard.  
 Max. working pressure: 16 bar.  
 Temperature range: -25–120 °C.



**5881**

Three-piece elbow union fitting. PN 16.  
 Chrome plated.  
**For hydraulic and domestic water systems:**  
 black O-Ring according to EN 681.1 standard.  
 Max. working pressure: 16 bar.  
 Temperature range: -25–120 °C.

Code				
588031	3/8" F	x M with union	1	50
588041	1/2" F	x M with union	1	50
588051	3/4" F	x M with union	1	25
588061	1" F	x M with union	1	20
588071	1 1/4" F	x M with union	1	10
588081	1 1/2" F	x M with union	1	-
588091	2" F	x M with union	1	-

Code				
588131	3/8" F	x M with union	1	50
588141	1/2" F	x M with union	1	25
588151	3/4" F	x M with union	1	25
588161	1" F	x M with union	1	15
588171	1 1/4" F	x M with union	1	10

UNIONS



Flat seat union with gasket.

Code		
R59787	3/4" F	x 1/2" M
R59788	1" F	x 3/4" M
R59789	1 1/4" F	x 1" M
R59485	1 1/2" F	x 1 1/4" M
R59581	2" F	x 1 1/2" M
R59487	2 1/2" F	x 2" M

O-Ring seal

The hydraulic tightness between the two fitting components is a tapered type with O-Ring. This allows to screw the fitting up smoothly with a full safety warranty.

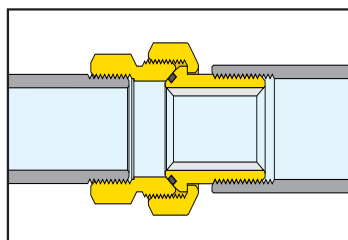

**FITTINGS FOR POLYETHYLENE PIPES (PE-X)**



**930**

Male elbow fitting with wall connection. Fitted for coupling with fittings 347, 438 and 680 series for water use.

Code			
<b>930418</b>	1/2" F x 23 p.1,5 M	5	-



**944**

Male elbow fitting.

Code			
<b>944400</b>	1/2" M x 23 p.1,5	50	-
<b>943550</b>	3/4" M x 3/4"	50	-



**940**

Male fitting.

Code			
<b>940300</b>	3/8" M x 23 p.1,5	50	-
<b>940400</b>	1/2" M x 23 p.1,5	50	-
<b>940450</b>	1/2" M x 3/4"	50	-
<b>940500</b>	3/4" M x 23 p.1,5	50	-



**945**

Female elbow fitting.

Code			
<b>945400</b>	1/2" F x 23 p.1,5	50	-
<b>945550</b>	3/4" F x 3/4"	50	-



**941**

Female fitting.

Code			
<b>941300</b>	3/8" F x 23 p.1,5	50	-
<b>941400</b>	1/2" F x 23 p.1,5	50	-
<b>941450</b>	1/2" F x 3/4"	50	-
<b>941500</b>	3/4" F x 23 p.1,5	50	-
<b>941550</b>	3/4" F x 3/4"	50	-
<b>941560</b>	3/4" F x 1"	50	-



**946**

Tee piece.

Code			
<b>946000</b>	23 p.1,5 x 23 p.1,5 x 23 p.1,5	50	-
<b>946500</b>	3/4" x 3/4" x 3/4"	25	-



**942**

Sleeve.

Code			
<b>942000</b>	23 p.1,5 x 23 p.1,5	50	-
<b>942550</b>	3/4" x 3/4"	50	-
<b>942560</b>	3/4" x 1"	50	-



**947**

Side male tee piece.

Code			
<b>947400</b>	1/2" M x 23 p.1,5 x 23 p.1,5	50	-
<b>947500</b>	3/4" M x 3/4" x 3/4" (use <b>946500</b> )	50	-



**943**

Elbow fitting.

Code			
<b>943000</b>	23 p.1,5 x 23 p.1,5	50	-
<b>943550</b>	3/4" x 3/4"	50	-



**948**

Central male tee piece.

Code			
<b>948400</b>	23 p.1,5 x 1/2" M x 23 p.1,5	50	-
<b>946500</b>	3/4" x 3/4" M x 3/4"	50	-

**MECHANICAL FITTINGS WITH O-RING SEAL**

according to EN 1254-2 and EN 1254-4 standards

**0** for gas and fluid hydrocarbons - EN 549 standard (not including gasoline)

**0** for hydraulic and domestic water systems - EN 681.1 standard

Fittings highlighted in yellow are supplied with two O-Rings: yellow to be used for gas and fluid hydrocarbons - black to be used for hydraulic systems



**900**  
Female fitting. For annealed copper, hard copper, brass, mild steel and stainless steel pipes. Double O-Ring. According to EN 1254-4 standard.  
**For gas and fluid hydrocarbons:** yellow O-Ring according to EN 549 standard. Temperature range: -20–100 °C.  
**For hydraulic and domestic water systems:** black O-Ring according to EN 681.1 standard. Max. working pressure: 16 bar. Temperature range: -25–120 °C.



**904**  
Male fitting. For annealed copper, hard copper, brass, mild steel and stainless steel pipes. Double O-Ring. According to EN 1254-4 standard.  
**For gas and fluid hydrocarbons:** yellow O-Ring according to EN 549 standard. Temperature range: -20–100 °C.  
**For hydraulic and domestic water systems:** black O-Ring according to EN 681.1 standard. Max. working pressure: 16 bar. Temperature range: -25–120 °C.

Code			
900308	3/8" F - Ø 8	50	-
900310	3/8" F - Ø 10	50	-
900312	3/8" F - Ø 12	50	-
900314	3/8" F - Ø 14	50	-
900410	1/2" F - Ø 10	50	-
900412	1/2" F - Ø 12	50	-
900414	1/2" F - Ø 14	50	-
900415	1/2" F - Ø 15	50	-
900416	1/2" F - Ø 16	50	-
900418	1/2" F - Ø 18	25	-
900516	3/4" F - Ø 16	50	-
900518	3/4" F - Ø 18	25	-
900522	3/4" F - Ø 22	25	-
900622	1" F - Ø 22	25	-
900628*	1" F - Ø 28	25	-

\* To be used only with water and non-dangerous glycol solutions

Code			
904308	3/8" M - Ø 8	50	-
904310	3/8" M - Ø 10	50	-
904312	3/8" M - Ø 12	50	-
904314	3/8" M - Ø 14	50	-
904410	1/2" M - Ø 10	50	-
904412	1/2" M - Ø 12	50	-
904414	1/2" M - Ø 14	50	-
904415	1/2" M - Ø 15	50	-
904416	1/2" M - Ø 16	50	-
904418	1/2" M - Ø 18	25	-
904514	3/4" M - Ø 14	50	-
904516	3/4" M - Ø 16	50	-
904518	3/4" M - Ø 18	25	-
904522	3/4" M - Ø 22	25	-
904618	1" M - Ø 18	25	-
904622	1" M - Ø 22	25	-
904628 *	1" M - Ø 28	10	-

\* To be used only with water and non-dangerous glycol solutions



**903**  
Coupling sleeve. For annealed copper, hard copper, brass, mild steel and stainless steel pipes. According to EN 1254-2 standard.

**For hydraulic and domestic water systems:** black O-Ring according to EN 681.1 standard. Max. working pressure: 16 bar. Temperature range: -25–120 °C.

Code			
903008	Ø 8	50	-
903010	Ø 10	50	-
903012	Ø 12	50	-
903014	Ø 14	50	-
903015	Ø 15	50	-
903016	Ø 16	50	-
903018	Ø 18	25	-
903022	Ø 22	25	-



**9050**  
Elbow fitting. For annealed copper, hard copper, brass, mild steel and stainless steel pipes. According to EN 1254-2 standard.

**For hydraulic and domestic water systems:** black O-Ring according to EN 681.1 standard. Max. working pressure: 16 bar. Temperature range: -25–120°C.

Code			
905010	Ø 10	25	-
905012	Ø 12	25	-
905014	Ø 14	25	-
905015	Ø 15	25	-
905016	Ø 16	25	-
905018	Ø 18	25	-
905022	Ø 22	25	-

MECHANICAL FITTINGS WITH O-RING SEAL

9057

Male elbow fitting. For annealed copper, hard copper, brass, mild steel and stainless steel pipes. Double O-Ring. According to EN 1254-4 standard.



**For gas and fluid hydrocarbons:**  
yellow O-Ring according to EN 549 standard.  
Temperature range: -20–100 °C.  
**For hydraulic and domestic water systems:**  
black O-Ring according to EN 681.1 standard.  
Max. working pressure: 16 bar.  
Temperature range: -25–120 °C.

Code			
905730	3/8" M - Ø 10	25	-
905732	3/8" M - Ø 12	25	-
905740	1/2" M - Ø 10	25	-
905742	1/2" M - Ø 12	25	-
905744	1/2" M - Ø 14	25	-
905745	1/2" M - Ø 15	25	-
905746	1/2" M - Ø 16	25	-
905748	1/2" M - Ø 18	25	-
905756	3/4" M - Ø 16	25	-
905758	3/4" M - Ø 18	25	-
905752	3/4" M - Ø 22	25	-

9060



Tee fitting. For annealed copper, hard copper, brass, mild steel and stainless steel pipes.

According to EN 1254-2 standard.

**For hydraulic and domestic water systems:**  
black O-Ring according to EN 681.1 standard.  
Max. working pressure: 16 bar.  
Temperature range: -25–120 °C.

Code			
906010	Ø 10	25	-
906012	Ø 12	25	-
906014	Ø 14	25	-
906015	Ø 15	25	-
906016	Ø 16	25	-
906018	Ø 18	25	-
906022	Ø 22	20	-

9058

Female elbow fitting. For annealed copper, hard copper, brass, mild steel and stainless steel pipes. Double O-Ring. According to EN 1254-4 standard.



**For gas and fluid hydrocarbons:**  
yellow O-Ring according to EN 549 standard.  
Temperature range: -20–100 °C.  
**For hydraulic and domestic water systems:**  
black O-Ring according to EN 681.1 standard.  
Max. working pressure: 16 bar.  
Temperature range: -25–120 °C.

Code			
905830	3/8" F - Ø 10	25	-
905832	3/8" F - Ø 12	25	-
905840	1/2" F - Ø 10	25	-
905842	1/2" F - Ø 12	25	-
905844	1/2" F - Ø 14	25	-
905845	1/2" F - Ø 15	25	-
905846	1/2" F - Ø 16	25	-
905848	1/2" F - Ø 18	25	-
905856	3/4" F - Ø 16	25	-
905858	3/4" F - Ø 18	25	-
905852	3/4" F - Ø 22	25	-

9067

Male tee fitting. For annealed copper, hard copper, brass, mild steel and stainless steel pipes. According to EN 1254-4 standard.

**For hydraulic and domestic water systems:**  
black O-Ring according to EN 681.1 standard.  
Max. working pressure: 16 bar.  
Temperature range: -25–120 °C.



Code			
906740	1/2" M - Ø 10	25	-
906742	1/2" M - Ø 12	25	-
906744	1/2" M - Ø 14	25	-
906745	1/2" M - Ø 15	25	-
906746	1/2" M - Ø 16	25	-
906758	3/4" M - Ø 18	25	-
906752	3/4" M - Ø 22	20	-

9068

Female tee fitting. For annealed copper, hard copper, brass, mild steel and stainless steel pipes. According to EN 1254-4 standard.

**For hydraulic and domestic water systems:**  
black O-Ring according to EN 681.1 standard.  
Max. working pressure: 16 bar.  
Temperature range: -25–120 °C.



Code			
906830	3/8" F - Ø 10	25	-
906832	3/8" F - Ø 12	25	-
906840	1/2" F - Ø 10	25	-
906842	1/2" F - Ø 12	25	-
906844	1/2" F - Ø 14	25	-
906845	1/2" F - Ø 15	25	-
906846	1/2" F - Ø 16	25	-
906858	3/4" F - Ø 18	25	-
906852	3/4" F - Ø 22	20	-

930



Elbow fitting with wall connection. For annealed copper, hard copper, brass, mild steel and stainless steel pipes. According to EN 1254-4 standard. With double O-Ring.

**For gas and fluid hydrocarbons:**  
yellow O-Ring according to EN 549 standard.  
Temperature range: -20–100 °C.  
**For hydraulic and domestic water systems:**  
black O-Ring according to EN 681.1 standard.  
Max. working pressure: 16 bar.  
Temperature range: -25–120 °C.

Code			
930412	1/2" F - Ø 12	25	-
930414	1/2" F - Ø 14	25	-
930416	1/2" F - Ø 16	25	-

## SPARE PARTS FOR MECHANICAL FITTINGS WITH O-RING SEAL



Spare O-Ring.  
For 900, 903, 904, 9050, 9057, 9058, 9060, 9067, 9068, 930, 910, 913 and 914 series mechanical fittings.  
For hydraulic systems and for human consumption.

Code

<b>R97020</b>	Ø 8
<b>R97022*</b>	Ø 10
<b>R97021</b>	Ø 10
<b>R97023</b>	Ø 12
<b>R97024</b>	Ø 14
<b>R47037</b>	Ø 15
<b>R97025</b>	Ø 16
<b>R97026</b>	Ø 18
<b>R97027</b>	Ø 22

\* Only for fittings 900310, 903010, 904310, 910310, 913010 and 914310.



Spare O-Ring.  
For 900, 904, 910310 9057, 9058, 930 series mechanical fittings  
For gas and liquid fuel systems (not including gasoline).

Code

<b>R97012</b>	Ø 10
<b>R97013*</b>	Ø 10
<b>R97014</b>	Ø 12
<b>R97015</b>	Ø 14
<b>R97016</b>	Ø 15
<b>R97017</b>	Ø 16
<b>R97018</b>	Ø 18
<b>R97019</b>	Ø 22

\* Only for fittings 900310, 904310, 905730 and 905830.



Spare locking ring.  
For 900, 903, 904, 9050, 9057, 9058, 9060, 9067, 9068, 930, 910, 913 and 914 series mechanical fittings.

Code

<b>R91236</b>	Ø 8
<b>R91237*</b>	Ø 10
<b>R91238</b>	Ø 10
<b>R91239</b>	Ø 12
<b>R41423</b>	Ø 14
<b>R41424</b>	Ø 15
<b>R91240</b>	Ø 16
<b>R41448</b>	Ø 18
<b>R91235</b>	Ø 22
<b>R91241</b>	Ø 28

\* Only for fittings 900310, 903010, 904310, 910310, 913010 and 914310.

## MECHANICAL FITTINGS WITH O-RING SEAL

### 910



Female fitting. Chrome plated.  
For annealed copper, hard copper, brass, mild steel and stainless steel pipes.  
According to EN 1254-4 standard.  
**For hydraulic and domestic water systems:**  
black O-Ring according to EN 681.1 standard.  
Max. working pressure: 16 bar.  
Temperature range: -25–120 °C.

Code

<b>910310</b>	3/8" F - Ø 10	50	–
<b>910312</b>	3/8" F - Ø 12	50	–
<b>910314</b>	3/8" F - Ø 14	50	–
<b>910410</b>	1/2" F - Ø 10	50	–
<b>910412</b>	1/2" F - Ø 12	50	–
<b>910414</b>	1/2" F - Ø 14	50	–
<b>910415</b>	1/2" F - Ø 15	50	–



### 914



Male fitting. Chrome plated.  
For annealed copper, hard copper, brass, mild steel and stainless steel pipes.  
According to EN 1254-4 standard.  
**For hydraulic and domestic water systems:**  
black O-Ring according to EN 681.1 standard.  
Max. working pressure: 16 bar.  
Temperature range: -25–120 °C.

Code

<b>914310</b>	3/8" M - Ø 10	50	–
<b>914312</b>	3/8" M - Ø 12	50	–
<b>914314</b>	3/8" M - Ø 14	50	–
<b>914410</b>	1/2" M - Ø 10	50	–
<b>914412</b>	1/2" M - Ø 12	50	–
<b>914414</b>	1/2" M - Ø 14	50	–
<b>914415</b>	1/2" M - Ø 15	50	–



### 913

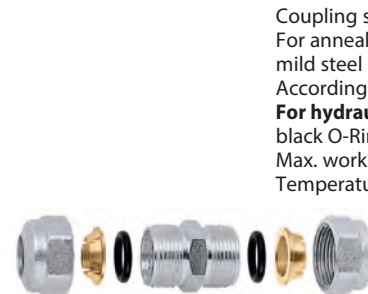

Coupling sleeve. Chrome plated.  
For annealed copper, hard copper, brass, mild steel and stainless steel pipes.  
According to EN 1254-2 standard.  
**For hydraulic and domestic water systems:**  
black O-Ring according to EN 681.1 standard.  
Max. working pressure: 16 bar.  
Temperature range: -25–120 °C.

Code

<b>913010</b>	Ø 10	50	–
<b>913012</b>	Ø 12	50	–
<b>913014</b>	Ø 14	50	–



Mechanical fittings with O-Ring seal are not suitable for use with fuel added with RME (Rape Methyl Ester).



DECA-FITTINGS FOR POLYETHYLENE PIPES



860

tech. broch. 01037

Female fitting.  
In brass.  
For polyethylene pipes.  
Max. working pressure: 16 bar.  
Max. working temperature: 40 °C.



Code			
860420	Ø 20 x 1/2" F	12	60
860421*	Ø 21 x 1/2" F	12	60
860525	Ø 25 x 3/4" F	10	50
860527*	Ø 27 x 3/4" F	10	50
860625	Ø 25 x 1" F	10	60
860632	Ø 32 x 1" F	10	50
860634*	Ø 34 x 1" F	10	50
860740	Ø 40 x 1 1/4" F	10	50
860850	Ø 50 x 1 1/2" F	5	25
860963	Ø 63 x 2" F	8	-

\* Without DVGW and SVGW certifications



861

tech. broch. 01037

Male fitting.  
In brass.  
For polyethylene pipes.  
Max. working pressure: 16 bar.  
Max. working temperature: 40 °C.



Code			
861420	Ø 20 x 1/2" M	12	60
861421*	Ø 21 x 1/2" M	12	60
861525	Ø 25 x 3/4" M	10	50
861527*	Ø 27 x 3/4" M	10	50
861625	Ø 25 x 1" M	10	60
861632	Ø 32 x 1" M	10	50
861634*	Ø 34 x 1" M	10	50
861740	Ø 40 x 1 1/4" M	10	50
861850	Ø 50 x 1 1/2" M	5	25
861963	Ø 63 x 2" M	8	-

\* Without DVGW and SVGW certifications



860

tech. broch. 01037

Female fitting.  
In cast iron.  
Stainless steel rods.  
For polyethylene pipes.  
Max. working pressure: 10 bar.  
Max. working temperature: 40 °C.

Code			
860075	Ø 75 x 2 1/2" F	1	-
860090	Ø 90 x 3" F	1	-
860110	Ø 110 x 4" F	1	-



861

tech. broch. 01037

Male fitting.  
In cast iron.  
Stainless steel rods.  
For polyethylene pipes.  
Max. working pressure: 10 bar.  
Max. working temperature: 40 °C.

Code			
861075	Ø 75 x 2 1/2" M	1	-
861090	Ø 90 x 3" M	1	-
861110	Ø 110 x 4" M	1	-



875

tech. broch. 01037

Reduced female fitting.  
In brass.  
For polyethylene pipes.  
Max. working pressure: 16 bar.  
Max. working temperature: 40 °C.



Code			
875425	Ø 25 x 1/2" F	10	50
875532	Ø 32 x 3/4" F	10	50
875640	Ø 40 x 1" F	10	50



876

tech. broch. 01037

Female fitting with union.  
In brass.  
For polyethylene pipes.  
Max. working pressure: 16 bar.  
Max. working temperature: 40 °C.



Code			
876520	Ø 20 x 3/4"	15	75
876525	Ø 25 x 3/4"	12	60
876625	Ø 25 x 1"	12	60
876632	Ø 32 x 1"	10	50

DECA-FITTINGS FOR POLYETHYLENE PIPES



862

tech. broch. 01037

Reduced male fitting.  
In brass.  
For polyethylene pipes.  
Max. working pressure: 16 bar.  
Max. working temperature: 40 °C.



Code			
862320	Ø 20 x 3/8" M	12	60
862425	Ø 25 x 1/2" M	10	50
862532	Ø 32 x 3/4" M	10	50
862640	Ø 40 x 1" M	10	50
862750	Ø 50 x 1 1/4" M	5	25
862863	Ø 63 x 1 1/2" M	8	-



863

tech. broch. 01037

Sleeve fitting.  
In cast iron.  
Stainless steel rods.  
For polyethylene pipes.  
Max. working pressure: 10 bar.  
Max. working temperature: 40 °C.

Code			
863075	Ø 75	1	-
863090	Ø 90	1	-
863110	Ø 110	1	-
863125	Ø 125	1	-



888

tech. broch. 01037

Flanged fitting,  
PN 10 EN 1092-1 series.  
In cast iron.  
Stainless steel rods.  
For polyethylene pipes.  
Max. working pressure: 10 bar.  
Max. working temperature: 40 °C.

Code			
888075	Ø 75 x DN 65	1	-
888090	Ø 90 x DN 80	1	-
888110	Ø 110 x DN 100	1	-
888125	Ø 125 x DN 100	1	-



864

tech. broch. 01037

Tee fitting.  
In brass.  
For polyethylene pipes.  
Max. working pressure: 16 bar.  
Max. working temperature: 40 °C.



Code			
864020	Ø 20	10	50
864021*	Ø 21	10	50
864025	Ø 25	10	50
864027*	Ø 27	5	25
864032	Ø 32	5	25
864034*	Ø 34	4	20
864040	Ø 40	5	-
864050	Ø 50	5	-
864063	Ø 63	5	-

\* Without DVGW and SVGW certifications



863

tech. broch. 01037

Sleeve fitting.  
In brass.  
For polyethylene pipes.  
Max. working pressure: 16 bar.  
Max. working temperature: 40 °C.



Code			
863020	Ø 20	15	75
863021*	Ø 21	15	75
863025	Ø 25	12	60
863027*	Ø 27	10	50
863032	Ø 32	10	50
863034*	Ø 34	5	25
863040	Ø 40	5	25
863050	Ø 50	5	25
863063	Ø 63	6	-

\* Without DVGW and SVGW certifications



865

tech. broch. 01037

Reduced male-female tee fitting.  
In brass.  
For polyethylene pipes.  
Max. working pressure: 16 bar.  
Max. working temperature: 40 °C.



Code			
865420	Ø 20 x 1/2" M x 3/8" F	10	50
865525	Ø 25 x 3/4" M x 1/2" F	10	50
865632	Ø 32 x 1" M x 3/4" F	5	25
865740	Ø 40 x 1 1/4" M x 1" F	5	-
865850	Ø 50 x 1 1/2" M x 1 1/4" F	5	-
865963	Ø 63 x 2" M x 1 1/2" F	5	-

DECA-FITTINGS FOR POLYETHYLENE PIPES



866

tech. broch. 01037

Elbow fitting.  
In brass.  
For polyethylene pipes.  
Max. working pressure: 16 bar.  
Max. working temperature: 40 °C.



Code			
866020	Ø 20	10	50
866025	Ø 25	10	50
866032	Ø 32	5	25
866040	Ø 40	4	20
866050	Ø 50	3	15
866063	Ø 63	5	-



869

tech. broch. 01037

Female elbow fitting  
with wall connections.  
In brass.  
For polyethylene pipes.  
Max. working pressure: 16 bar.  
Max. working temperature: 40 °C.



Code			
869420	Ø 20 x 1/2" F	5	25
869425	Ø 25 x 1/2" F	4	20
869525	Ø 25 x 3/4" F	4	20



867

tech. broch. 01037

Male elbow fitting.  
In brass.  
For polyethylene pipes.  
Max. working pressure: 16 bar.  
Max. working temperature: 40 °C.



Code			
867420	Ø 20 x 1/2" M	10	50
867525	Ø 25 x 3/4" M	10	50
867632	Ø 32 x 1" M	10	50
867740	Ø 40 x 1 1/4" M	4	20
867850	Ø 50 x 1 1/2" M	4	20
867963	Ø 63 x 2" M	5	-



870

tech. broch. 01037

Long sleeve fitting.  
Can be used for pipe repairs.  
In brass.  
For polyethylene pipes.

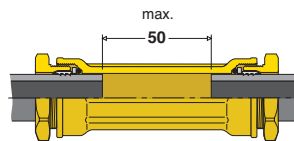

Allows pipe repairs  
with a maximum distance of 50 mm  
between pipe ends.

Max. working pressure: 16 bar.  
Max. working temperature: 40 °C.



Code			
870025	Ø 25	10	50
870032	Ø 32	5	25
870040	Ø 40	4	20
870050	Ø 50	3	15



868

tech. broch. 01037

Female elbow fitting.  
In brass.  
For polyethylene pipes.  
Max. working pressure: 16 bar.  
Max. working temperature: 40 °C.



Code			
868420	Ø 20 x 1/2" F	10	50
868525	Ø 25 x 3/4" F	10	50
868632	Ø 32 x 1" F	10	50
868740	Ø 40 x 1 1/4" F	4	20
868850	Ø 50 x 1 1/2" F	4	20
868963	Ø 63 x 2" F	5	-



871

tech. broch. 01037

Fitting with ball valve.  
In brass.  
For polyethylene pipes.  
Max. working pressure: 16 bar.  
Max. working temperature: 40 °C.



Code			
871425	Ø 25 x 1/2" F	10	50
871525	Ø 25 x 3/4" F	5	25
871532	Ø 32 x 3/4" F	5	25

**DEZINCIFICATION RESISTANT ALLOY FITTINGS FOR POLYETHYLENE PIPES**



**960**

Female fitting.  
In **CR** dezincification resistant alloy.  
For polyethylene pipes.  
Max. working pressure: 16 bar.  
Max. working temperature: 40 °C.

Code



<b>960420</b>	Ø 20 x 1/2" F	12	60
<b>960525</b>	Ø 25 x 3/4" F	10	50
<b>960625</b>	Ø 25 x 1" F	10	60
<b>960632</b>	Ø 32 x 1" F	10	50
<b>960740</b>	Ø 40 x 1 1/4" F	6	30
<b>960850</b>	Ø 50 x 1 1/2" F	5	20
<b>960963</b>	Ø 63 x 2" F	8	-



**962**

Reduced male fitting.  
In **CR** dezincification resistant alloy.  
For polyethylene pipes.  
Max. working pressure: 16 bar.  
Max. working temperature: 40 °C.

Code



<b>962532</b>	Ø 32 x 3/4" M	10	50
<b>962640</b>	Ø 40 x 1" M	6	30



**975**

Reduced female fitting.  
In **CR** dezincification resistant alloy.  
For polyethylene pipes.  
Max. working pressure: 16 bar.  
Max. working temperature: 40 °C.

Code



<b>975532</b>	Ø 32 x 3/4" F	10	50
<b>975640</b>	Ø 40 x 1" F	6	30
<b>975732</b>	Ø 32 x 1 1/4" F	6	30
<b>975750</b>	Ø 50 x 1 1/4" F	5	20



**963**

Sleeve fitting.  
In **CR** dezincification resistant alloy.  
For polyethylene pipes.  
Max. working pressure: 16 bar.  
Max. working temperature: 40 °C.

Code



<b>963020</b>	Ø 20	15	75
<b>963025</b>	Ø 25	12	60
<b>963032</b>	Ø 32	10	50
<b>963040</b>	Ø 40	5	20
<b>963050</b>	Ø 50	6	-
<b>963063</b>	Ø 63	5	-



**961**

Male fitting.  
In **CR** dezincification resistant alloy.  
For polyethylene pipes.  
Max. working pressure: 16 bar.  
Max. working temperature: 40 °C.

Code



<b>961420</b>	Ø 20 x 1/2" M	12	60
<b>961520</b>	Ø 20 x 3/4" M	12	60
<b>961525</b>	Ø 25 x 3/4" M	10	50
<b>961625</b>	Ø 25 x 1" M	10	60
<b>961632</b>	Ø 32 x 1" M	10	50
<b>961732</b>	Ø 32 x 1 1/4" M	10	50
<b>961740</b>	Ø 40 x 1 1/4" M	6	30
<b>961840</b>	Ø 40 x 1 1/2" M	6	30
<b>961850</b>	Ø 50 x 1 1/2" M	5	20
<b>961950</b>	Ø 50 x 2" M	5	20
<b>961963</b>	Ø 63 x 2" M	8	-



**964**

Tee fitting.  
In **CR** dezincification resistant alloy.  
For polyethylene pipes.  
Max. working pressure: 16 bar.  
Max. working temperature: 40 °C.

Code



<b>964020</b>	Ø 20	10	50
<b>964025</b>	Ø 25	10	50
<b>964032</b>	Ø 32	5	25
<b>964040</b>	Ø 40	5	-
<b>964050</b>	Ø 50	5	-

**DEZINCIFICATION RESISTANT ALLOY FITTINGS FOR POLYETHYLENE PIPES**



**966**

Elbow fitting.  
In **CR** dezincification resistant alloy.  
For polyethylene pipes.  
Max. working pressure: 16 bar.  
Max. working temperature: 40 °C.

Code			
<b>966025</b>	Ø 25	10	50
<b>966032</b>	Ø 32	5	25
<b>966040</b>	Ø 40	3	15



**970**

Long sleeve fitting.  
In **CR** dezincification resistant alloy.  
For polyethylene pipes.

Allows pipe repairs with a maximum distance of 50 mm between pipe ends.

Max. working pressure: 16 bar.  
Max. working temperature: 40 °C.

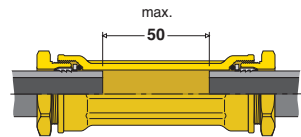

Code			
<b>970032</b>	Ø 32	5	25
<b>970040</b>	Ø 40	5	-
<b>970050</b>	Ø 50	4	-



**967**

Male elbow fitting.  
In **CR** dezincification resistant alloy.  
For polyethylene pipes.  
Max. working pressure: 16 bar.  
Max. working temperature: 40 °C.

Code			
<b>967632</b>	Ø 32 x 1" M	10	50



**986**

Reduction kit.

Code			
<b>986032</b>	from Ø 32 to Ø 25	12	60
<b>986043</b>	from Ø 40 to Ø 32	10	50
<b>986053</b>	from Ø 50 to Ø 32	6	30
<b>986054</b>	from Ø 50 to Ø 40	6	30



**968**

Female elbow fitting.  
In **CR** dezincification resistant alloy.  
For polyethylene pipes.  
Max. working pressure: 16 bar.  
Max. working temperature: 40 °C.

Code			
<b>968632</b>	Ø 32 x 1" F	10	50
<b>968740</b>	Ø 40 x 1 1/4" F	4	20



**980**

Kit.

Code			
<b>980025</b>	Ø 25	100	-
<b>980032</b>	Ø 32	100	-
<b>980040</b>	Ø 40	50	-
<b>980050</b>	Ø 50	50	-
<b>980063</b>	Ø 63	50	-

DECA-FITTINGS FOR STEEL PIPES

Steel series

For steel pipes with nominal outer diameters for gas threading. Stainless steel pipe clenching ring.



890

Female fitting. In brass.  
For steel pipe.  
Max. working pressure: 16 bar.  
Max. working temperature: 40 °C.



Code				
890421	Ø 21 x 1/2" F	12	60	
890527	Ø 27 x 3/4" F	10	50	
890634	Ø 34 x 1" F	10	50	



891

Male fitting. In brass.  
For steel pipe.  
Max. working pressure: 16 bar.  
Max. working temperature: 40 °C.



Code				
891421	Ø 21 x 1/2" M	12	60	
891527	Ø 27 x 3/4" M	10	50	
891634	Ø 34 x 1" M	10	50	



893

Sleeve fitting. In brass.  
For steel pipe.  
Without internal stop to be used as joint repair sleeve.

Can be used for pipe repair with a maximum distance of 15 mm between pipe ends.

Max. working pressure: 16 bar.  
Max. working temperature: 40 °C.

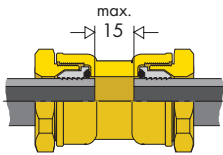

Code				
893021	Ø 21	15	75	
893027	Ø 27	10	50	
893034	Ø 34	5	25	



894

Tee fitting. In brass.  
For steel pipe.  
Max. working pressure: 16 bar.  
Max. working temperature: 40 °C.



Code				
894021	Ø 21	10	50	
894027	Ø 27	5	25	
894034	Ø 34	4	20	

Example of use on steel pipes

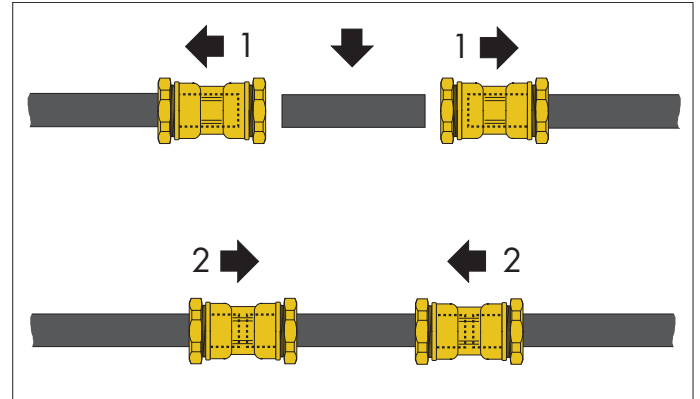

Example of repair with the insertion of a supplementary sleeve.

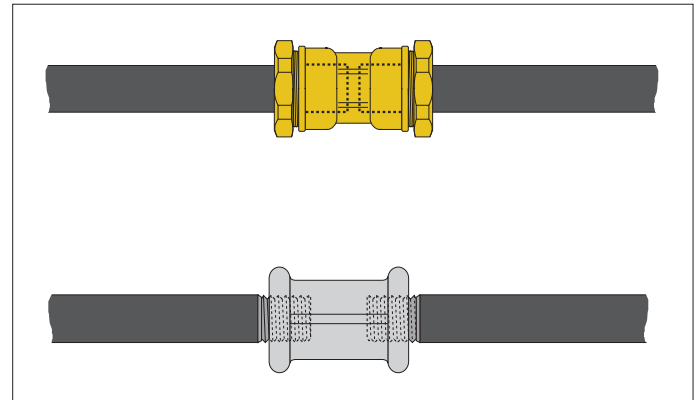

In order to avoid corrosion, which is typical when traditional threaded sleeves are used (see diagram in grey colour), the application of the **Steel series fittings** (see diagram in yellow colour) allows piping to keep the complete galvanisation.

The traditional sleeve in fact does not cover the entire threaded part which is therefore subjected to high corrosion since it features no galvanisation and is weakened on the diameter.

**ACCESSORIES AND SPARE PARTS FOR DECA-FITTINGS**



**886**  
Reduction kit.



Code			
<b>886022</b>	from Ø 25 to Ø 20	1	-
<b>886032</b>	from Ø 32 to Ø 25	1	-
<b>886043</b>	from Ø 40 to Ø 32	1	-
<b>886054</b>	from Ø 50 to Ø 40	1	-
<b>886065</b>	from Ø 63 to Ø 50	1	-



**887**  
Pipe stiffener.



PN 10 series

Code			
<b>887120</b>	20 x 2	10	-
<b>887223</b>	25 x 2,3	10	-
<b>887330</b>	32 x 3	10	-
<b>887437</b>	40 x 3,7	5	-
<b>887546</b>	50 x 4,6	5	-
<b>887658</b>	63 x 5,8	5	-

For REHAU pipes

Code			
<b>887128</b>	20 x 2,8	10	-
<b>887235</b>	25 x 3,5	10	-

S 5 PN 4 series

Code			
<b>887130</b>	20 x 3	10	-
<b>887230</b>	25 x 3	10	-
<b>887330</b>	32 x 3	10	-
<b>887437</b>	40 x 3,7	5	-
<b>887546</b>	50 x 4,6	5	-
<b>887658</b>	63 x 5,8	5	-

S 8 PN 2,5-4 series

Code			
<b>887430</b>	40 x 3	5	-
<b>887530</b>	50 x 3	5	-
<b>887636</b>	63 x 3,6	5	-



**877**  
Pipe clenching ring.

Code			
<b>877020</b>	Ø 20 brass	1	-
<b>877021</b>	Ø 21 brass	1	-
<b>877121</b>	Ø 21 stainless steel	1	-
<b>877025</b>	Ø 25 brass	1	-
<b>877027</b>	Ø 27 brass	1	-
<b>877127</b>	Ø 27 stainless steel	1	-
<b>877032</b>	Ø 32 brass	1	-
<b>877034</b>	Ø 34 brass	1	-
<b>877134</b>	Ø 34 stainless steel	1	-
<b>877040</b>	Ø 40 brass	1	-
<b>877050</b>	Ø 50 brass	1	-
<b>877063</b>	Ø 63 brass	1	-



**878**  
Brass washer.

Code			
<b>878020</b>	Ø 20	1	-
<b>878021</b>	Ø 21	1	-
<b>878025</b>	Ø 25	1	-
<b>878027</b>	Ø 27	1	-
<b>878032</b>	Ø 32	1	-
<b>878034</b>	Ø 34	1	-
<b>878040</b>	Ø 40	1	-
<b>878050</b>	Ø 50	1	-
<b>878063</b>	Ø 63	1	-



**879**  
O-Ring.

Code			
<b>879020</b>	Ø 20	1	-
<b>879021</b>	Ø 21	1	-
<b>879025</b>	Ø 25	1	-
<b>879027</b>	Ø 27	1	-
<b>879032</b>	Ø 32	1	-
<b>879034</b>	Ø 34	1	-
<b>879040</b>	Ø 40	1	-
<b>879050</b>	Ø 50	1	-
<b>879063</b>	Ø 63	1	-





## GAS SAFETY

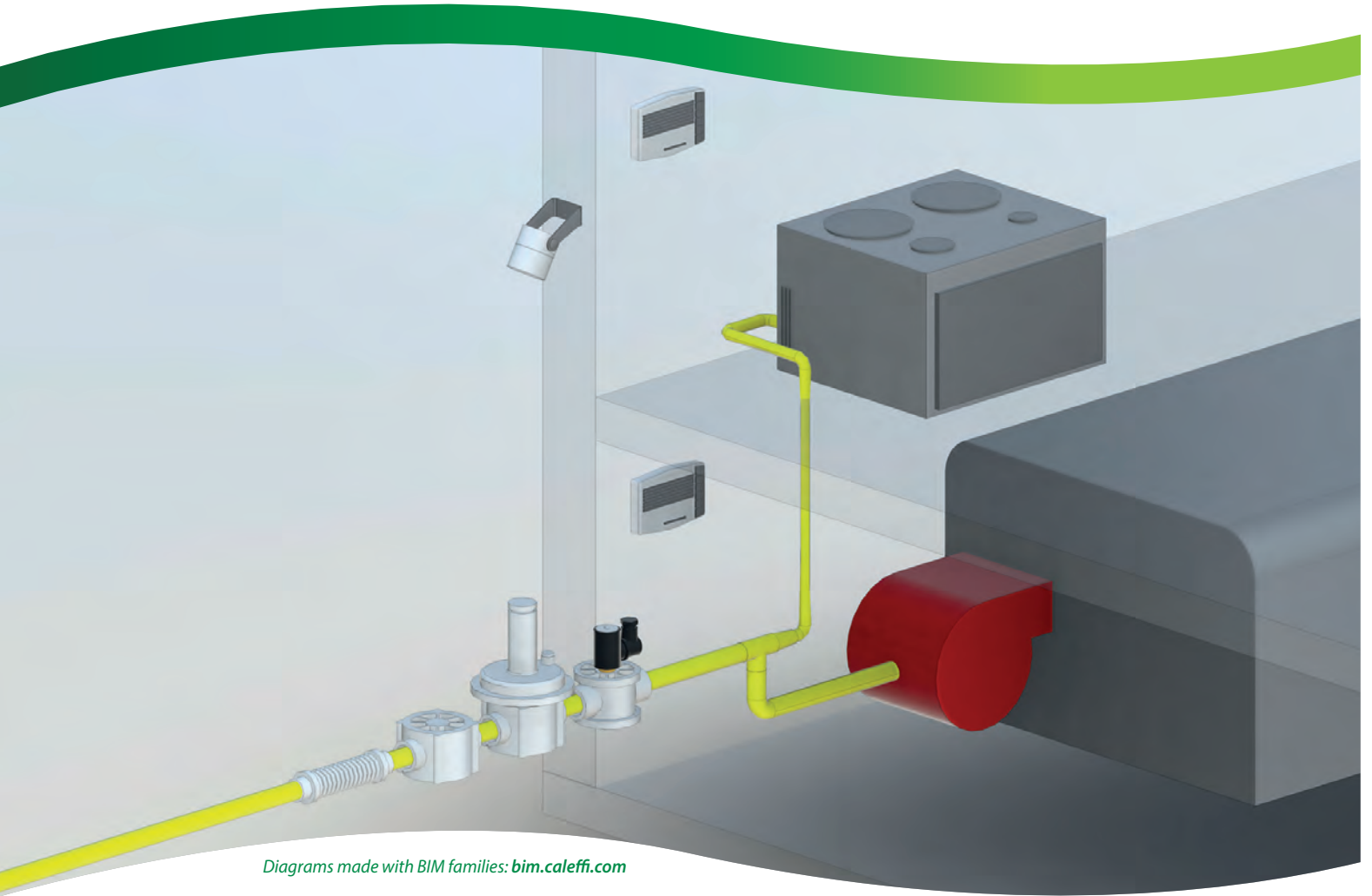

*Diagrams made with BIM families: [bim.caleffi.com](http://bim.caleffi.com)*

- Gas filters**
- Gas pressure filter regulators**
- Gas pressure regulators**
- Antivibration extendible joints for gas systems**
- Pressure gauge for gas**
- Solenoid valves for gas**
- Gas detectors**

**GAS FILTERS**



**847**

Compact gas filter.  
Max. pressure: 2 bar.  
Filtration:  $\varnothing \geq 50 \mu\text{m}$ .  
Filtration class: G 2 (to EN 779).



Code

Code	Size	Green Box	Yellow Box
847004	1/2"	1	-
847005	3/4"	1	-



**848**

Gas filter.  
Max. pressure: 2 bar.  
Filtration:  $\varnothing \geq 50 \mu\text{m}$ .  
Filtration class: G 2 (to EN 779).



Code

Code	Size	Green Box	Yellow Box
848004	1/2"	1	-
848005	3/4"	1	-
848006	1"	1	-
848007	1 1/4"	1	-
848008	1 1/2"	1	-
848009	2"	1	-



**848**

Gas filter.  
Body PN 16.  
Flanged connection.  
To be coupled with flat counterflanges EN 1092-1.  
Max. pressure: 2 bar.  
Filtration:  $\varnothing \geq 50 \mu\text{m}$ .  
Filtration class: G 2 (to EN 779).



Code

Code	Size	Green Box	Yellow Box
848060	DN 65	1	-
848080	DN 80	1	-
848100	DN 100	1	-

**GAS PRESSURE FILTER REGULATORS**



**850**

Gas pressure closing filter regulator, double diaphragm.  
Threaded connections.  
Max. inlet pressure: 500 mbar.  
Temperature range: -15-60 °C.  
Regulation and closing at null flow according to UNI EN 88.  
Filtration:  $\varnothing \geq 50 \mu\text{m}$ .  
Filtration class: G 2 (to EN 779).  
Conformity to Directive ATEX (II 2G - II 2D).



Code	Size	Adjustment (mbar)	Green Box	Yellow Box
850004	1/2"	18-40	1	-
850005	3/4"	18-40	1	-
850006	1"	18-40	1	-
850007	1 1/4"	13-23	1	-
850008	1 1/2"	13-23	1	-
850009	2"	13-23	1	-



**850**

Gas pressure closing filter regulator, double diaphragm.  
Body PN 16.  
Flanged connection.  
To be coupled with flat counterflanges EN 1092-1.  
Max. inlet pressure: 500 mbar.  
Temperature range: -15-60 °C.  
Regulation and closing at null flow according to UNI EN 88.  
Filtration:  $\varnothing \geq 50 \mu\text{m}$ .  
Filtration class: G 2 (to EN 779).  
Conformity to Directive ATEX (II 2G - II 2D).



Code	Size	Adjustment (mbar)	Green Box	Yellow Box
850060	DN 65	13-27	1	-
850080	DN 80	13-27	1	-
850100	DN 100	15-27	1	-

**GAS PRESSURE REGULATORS**



**852**

Gas pressure closing regulator, double diaphragm. Threaded connections. Max. inlet pressure: 500 mbar. Temperature range: -15–60 °C. Regulation and closing at null flow according to UNI EN 88. Conformity to Directive ATEX (II 2G - II 2D).



Code	Adjustment (mbar)		
852004	1/2"	18–40	1 -
852005	3/4"	18–40	1 -
852006	1"	18–40	1 -
852007	1 1/4"	13–23	1 -
852008	1 1/2"	13–23	1 -
852009	2"	13–23	1 -

**ANTIVIBRATION EXTENDIBLE JOINTS FOR GAS SYSTEMS**



**841**

Extendible stainless steel joint according to UNI 11353, for gas systems in domestic applications (max. 35 kW). Max. working pressure PS: 0,5 bar.

Fixed male connection: AISI 303. Flexible: AISI 316L. Captive female connection: AISI 303.

Code	Min./max. L		
841414	1/2"	90/130	3 -
841514	3/4"	90/130	3 -
841614	1"	90/130	3 -
841420	1/2"	120/210	3 -
841520	3/4"	120/210	3 -
841620	1"	120/210	3 -
841440	1/2"	240/410	3 -
841540	3/4"	240/410	3 -
841640	1"	240/410	3 -



**852**

Gas pressure closing regulator, double diaphragm. Body PN 16. Flanged connection. To be coupled with flat counterflanges EN 1092-1. Max. inlet pressure: 500 mbar. Temperature range: -15–60 °C. Regulation and closing at null flow according to UNI EN 88. Conformity to Directive ATEX (II 2G - II 2D).



Code	Adjustment (mbar)		
852060	DN 65	13–27	1 -
852080	DN 80	13–27	1 -
852100	DN 100	15–27	1 -



**842**

Antivibration joint for gas systems. According to EN 676 standard. Max. working pressure PS: 0,5 bar.

Threaded version: body AISI 316L, fixed male connection: FE 37.

Flanged version: body AISI 321, free flanged connections: ASTM A 105 - PN 10. To be coupled with flat counterflanges EN 1092-1 (PN 10 - PN 16).

Code	L (mm)		
842004	1/2"	145	3 -
842005	3/4"	150	3 -
842006	1"	165	3 -
842007	1 1/4"	180	1 -
842008	1 1/2"	210	1 -
842009	2"	230	1 -
842060	DN 65	175	1 -
842080	DN 80	175	1 -
842100	DN 100	195	1 -

**GAS PRESSURE REGULATORS**



**8460**

Tap for gas pressure gauge, with opening button. Female connections.

Code			
846002	1/4"	1	-
846003	3/8"	1	-



**8461**

Pressure gauge for gas. Diaphragm precision sensitive element. Bottom connection. Accuracy: UNI 1,6.

Code	mbar	Ø		
846101	1/4"	0–60	60	1 -
846102	1/4"	0–100	60	1 -
846103	3/8"	0–60	80	1 -
846104	3/8"	0–100	80	1 -

**SOLENOID VALVES FOR GAS - NORMALLY OPEN - MANUAL RESET**



**8540**

Solenoid valve for gas, normally open, with manual reset. Max. pressure: 500 mbar. Protection class: IP 65.



Code	Electric supply			
<b>854024</b>	1/2"	230 V (AC)	1	-
<b>854025</b>	3/4"	230 V (AC)	1	-
<b>854044</b>	1/2"	24 V (AC)	1	-
<b>854045</b>	3/4"	24 V (AC)	1	-

Spare coil, complete with connector.

Code	Electric supply	Use		
<b>854012</b>	230 V (AC)	1/2" - 3/4"	1	-
<b>854014</b>	24 V (AC)	1/2" - 3/4"	1	-



**839**

Solenoid valve for gas, normally open, with manual reset. Max. pressure: 500 mbar. Protection class: IP 65.



Code	Electric supply			
<b>839005</b>	3/4"	230 V (AC)	1	-
<b>839006</b>	1"	230 V (AC)	1	-
<b>839007</b>	1 1/4"	230 V (AC)	1	-
<b>839008</b>	1 1/2"	230 V (AC)	1	-
<b>839009</b>	2"	230 V (AC)	1	-
<b>839105</b>	3/4"	24 V (AC)	1	-
<b>839106</b>	1"	24 V (AC)	1	-
<b>839107</b>	1 1/4"	24 V (AC)	1	-
<b>839108</b>	1 1/2"	24 V (AC)	1	-
<b>839109</b>	2"	24 V (AC)	1	-
<b>839205</b>	3/4"	12 V (DC)	1	-
<b>839206</b>	1"	12 V (DC)	1	-
<b>839207</b>	1 1/4"	12 V (DC)	1	-
<b>839208</b>	1 1/2"	12 V (DC)	1	-
<b>839209</b>	2"	12 V (DC)	1	-



**8540**

Solenoid valve for gas, normally open, with manual reset. Max. pressure: 500 mbar. Protection class: IP 65.



Code	Electric supply			
<b>854026</b>	1"	230 V (AC)	1	-
<b>854046</b>	1"	24 V (AC)	1	-

Spare coil, complete with connector.

Code	Electric supply	Use		
<b>854002</b>	230 V (AC)	1"	1	-
<b>854004</b>	24 V (AC)	1"	1	-

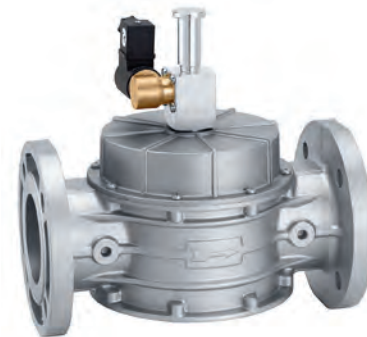

**839**

Solenoid valve for gas, normally open, with manual reset. Body PN 16. Max. pressure: 500 mbar. Protection class: IP 65.

Flanged connections PN 16. To be coupled with flat counterflanges EN 1092-1.



Code	Electric supply			
<b>839060</b>	DN 65	230 V (AC)	1	-
<b>839080</b>	DN 80	230 V (AC)	1	-
<b>839100</b>	DN 100	230 V (AC)	1	-
<b>839120</b>	DN 125	230 V (AC)	1	-
<b>839150</b>	DN 150	230 V (AC)	1	-
<b>839160</b>	DN 65	24 V (AC)	1	-
<b>839180</b>	DN 80	24 V (AC)	1	-
<b>839190</b>	DN 100	24 V (AC)	1	-
<b>839220</b>	DN 125	24 V (AC)	1	-
<b>839250</b>	DN 150	24 V (AC)	1	-

Spare coil, complete with connector.

Code	Electric supply	Use		
<b>839A05</b>	230 V (AC)	3/4"-DN 150	1	-
<b>839B05</b>	24 V (AC)	3/4"-DN 150	1	-
<b>839C05</b>	12 V (DC)	3/4"-DN 150	1	-

**SOLENOID VALVES FOR GAS - NORMALLY CLOSED - MANUAL RESET**



**8541**

Solenoid valve for gas, normally closed, with manual reset. Max. pressure: 500 mbar. Class A - Group 2. Protection class: IP 65.



Code	Electric supply			
854124	1/2"	230 V (AC)	1	-
854125	3/4"	230 V (AC)	1	-
854126	1"	230 V (AC)	1	-
854144	1/2"	24 V (AC)	1	-
854145	3/4"	24 V (AC)	1	-
854146	1"	24 V (AC)	1	-

Spare coil, complete with connector.

Code	Electric supply	Use		
854102	230 V (AC)	1/2"-1"	1	-
854104	24 V (AC)	1/2"-1"	1	-



**837**

Solenoid valve for gas, normally closed, with manual reset. Max. pressure: 500 mbar. Class A - Group 2. Protection class: IP 65.



Code	Electric supply			
837005	3/4"	230 V (AC)	1	-
837006	1"	230 V (AC)	1	-
837007	1 1/4"	230 V (AC)	1	-
837008	1 1/2"	230 V (AC)	1	-
837009	2"	230 V (AC)	1	-
837105	3/4"	24 V (AC)	1	-
837106	1"	24 V (AC)	1	-
837107	1 1/4"	24 V (AC)	1	-
837108	1 1/2"	24 V (AC)	1	-
837109	2"	24 V (AC)	1	-
837205	3/4"	12 V (DC)	1	-
837206	1"	12 V (DC)	1	-
837207	1 1/4"	12 V (DC)	1	-
837208	1 1/2"	12 V (DC)	1	-
837209	2"	12 V (DC)	1	-

Spare coil, complete with connector.

Code	Electric supply	Use		
837A05	230 V (AC)	3/4"-2"	1	-
837B05	24 V (AC)	3/4"-2"	1	-
837C05	12 V (DC)	3/4"-2"	1	-



**837**

Solenoid valve for gas, normally closed, with manual reset. Body PN 16. Max. pressure: 500 mbar. Class A - Group 2. Protection class: IP 65.

Flanged connections PN 16. To be coupled with flat counterflanges EN 1092-1.



Code	Electric supply			
837060	DN 65	230 V (AC)	1	-
837080	DN 80	230 V (AC)	1	-
837100	DN 100	230 V (AC)	1	-
837120	DN 125	230 V (AC)	1	-
837150	DN 150	230 V (AC)	1	-
837160	DN 65	24 V (AC)	1	-
837180	DN 80	24 V (AC)	1	-
837190	DN 100	24 V (AC)	1	-
837220	DN 125	24 V (AC)	1	-
837250	DN 150	24 V (AC)	1	-

Spare coil, complete with connector.

Code	Electric supply	Use		
837A60	230 V (AC)	DN 65-DN 150	1	-
837B60	24 V (AC)	DN 65-DN 150	1	-

**SOLENOID VALVES FOR GAS - NORMALLY CLOSED**



**838**

Solenoid valve for gas, normally closed.  
Max. pressure: 360 mbar.  
Class A - Group 2.  
Protection class: IP 65.



Code	Electric supply			
<b>838004</b>	1/2"	230 V (AC)	1	-
<b>838005</b>	3/4"	230 V (AC)	1	-
<b>838006</b>	1"	230 V (AC)	1	-
<b>838007*</b>	1 1/4"	230 V (AC)	1	-
<b>838008*</b>	1 1/2"	230 V (AC)	1	-
<b>838009*</b>	2"	230 V (AC)	1	-
<b>838104</b>	1/2"	24 V (AC)	1	-
<b>838105</b>	3/4"	24 V (AC)	1	-
<b>838106</b>	1"	24 V (AC)	1	-
<b>838107*</b>	1 1/4"	24 V (AC)	1	-
<b>838108*</b>	1 1/2"	24 V (AC)	1	-
<b>838109*</b>	2"	24 V (AC)	1	-

\* With upper hexagonal fixing nut



**838**

Solenoid valve for gas, normally closed.  
Body PN 16.  
Max. pressure: 200 mbar.  
Class A - Group 2.  
Protection class: IP 65.

Flanged connections PN 16.  
To be coupled with flat counterflanges EN 1092-1.



Code	Electric supply			
<b>838060</b>	DN 65	230 V (AC)	1	-
<b>838080</b>	DN 80	230 V (AC)	1	-
<b>838100</b>	DN 100	230 V (AC)	1	-
<b>838120</b>	DN 125	230 V (AC)	1	-
<b>838150</b>	DN 150	230 V (AC)	1	-
<b>838160</b>	DN 65	24 V (AC)	1	-
<b>838180</b>	DN 80	24 V (AC)	1	-
<b>838190</b>	DN 100	24 V (AC)	1	-
<b>838220</b>	DN 125	24 V (AC)	1	-
<b>838250</b>	DN 150	24 V (AC)	1	-



Spare coil, complete with connector.

Code	Electric supply	Use		
<b>838A04</b>	230 V (AC)	1/2" - 3/4" (round version)	1	-
<b>838A06</b>	230 V (AC)	1" (round version)	1	-
<b>838A07</b>	230 V (AC)	1 1/4"-2" (round version)	1	-
<b>838A17</b>	230 V (AC)	1 1/4"-2" (round version)*	1	-
<b>838B04</b>	24 V (AC)	1/2" - 3/4" (round version)	1	-
<b>838B06</b>	24 V (AC)	1" (round version)	1	-
<b>838B07</b>	24 V (AC)	1 1/4"-2" (round version)	1	-
<b>838B17</b>	24 V (AC)	1 1/4"-2" (round version)*	1	-

\* With upper hexagonal fixing nut



Spare coil, complete with connector.

Code	Electric supply	Use		
<b>838A60</b>	230 V (AC)	DN 65 - DN 80	1	-
<b>838A00</b>	230 V (AC)	DN 100	1	-
<b>838A20</b>	230 V (AC)	DN 125 - DN 150	1	-
<b>838B60</b>	24 V (AC)	DN 65 - DN 80	1	-
<b>838B00</b>	24 V (AC)	DN 100	1	-
<b>838B20</b>	24 V (AC)	DN 125 - DN 150	1	-

**ROTATING SIREN - BLINKER**



**8561**

Rotating siren.  
230 V (AC) - 112 dB/1 m.



Code		
<b>856102</b>	1	-



**8562**

Electronic intermittence blinker.  
230 V (AC) - Lamp power: 40 W.



Code		
<b>856202</b>	1	-

**GAS DETECTORS**



**8563**

Gas detector, with built-in sensor and relay outlet.  
With BUS connection, for auxiliary remote sensor.  
For solenoid valves 8540, 8541, 837, 838 and 839 series.  
Supply: 230 V (AC).  
Outlet contact: 8 (2) A.  
Protection class: IP 42.  
Domestic use.



Code

<b>856300</b>	for methane gas	1	-
<b>856302</b>	for LPG	1	-



**855**

Gas detector, with built-in sensor and relay outlet.  
Without BUS connection.  
With solenoid valve.  
Normally open.  
Supply: 230 V (AC).  
Protection class: IP 42.



Code

<b>855400</b>	1/2"	for methane gas	1	-
<b>855500</b>	3/4"	for methane gas	1	-
<b>855410</b>	1/2"	for LPG	1	-
<b>855510</b>	3/4"	for LPG	1	-



**8563**

Auxiliary remote sensor for gas detector 8563 series.  
Supply: 230 V (AC).  
Protection class: IP 42.  
Domestic use.



Code

<b>856310</b>	for methane gas	1	-
<b>856312</b>	for LPG	1	-



**8565**

Gas detector, with built-in sensor and relay outlet.  
Without BUS connection.  
Supply: 230 V (AC).  
Outlet contact: 8 (2) A.  
Protection class: IP 42.  
Domestic use.



Code

<b>856500</b>	for methane gas	1	-
<b>856502</b>	for LPG	1	-







# EXPANSION VESSELS, CHRONO-THERMOSTATS, THERMOSTATS

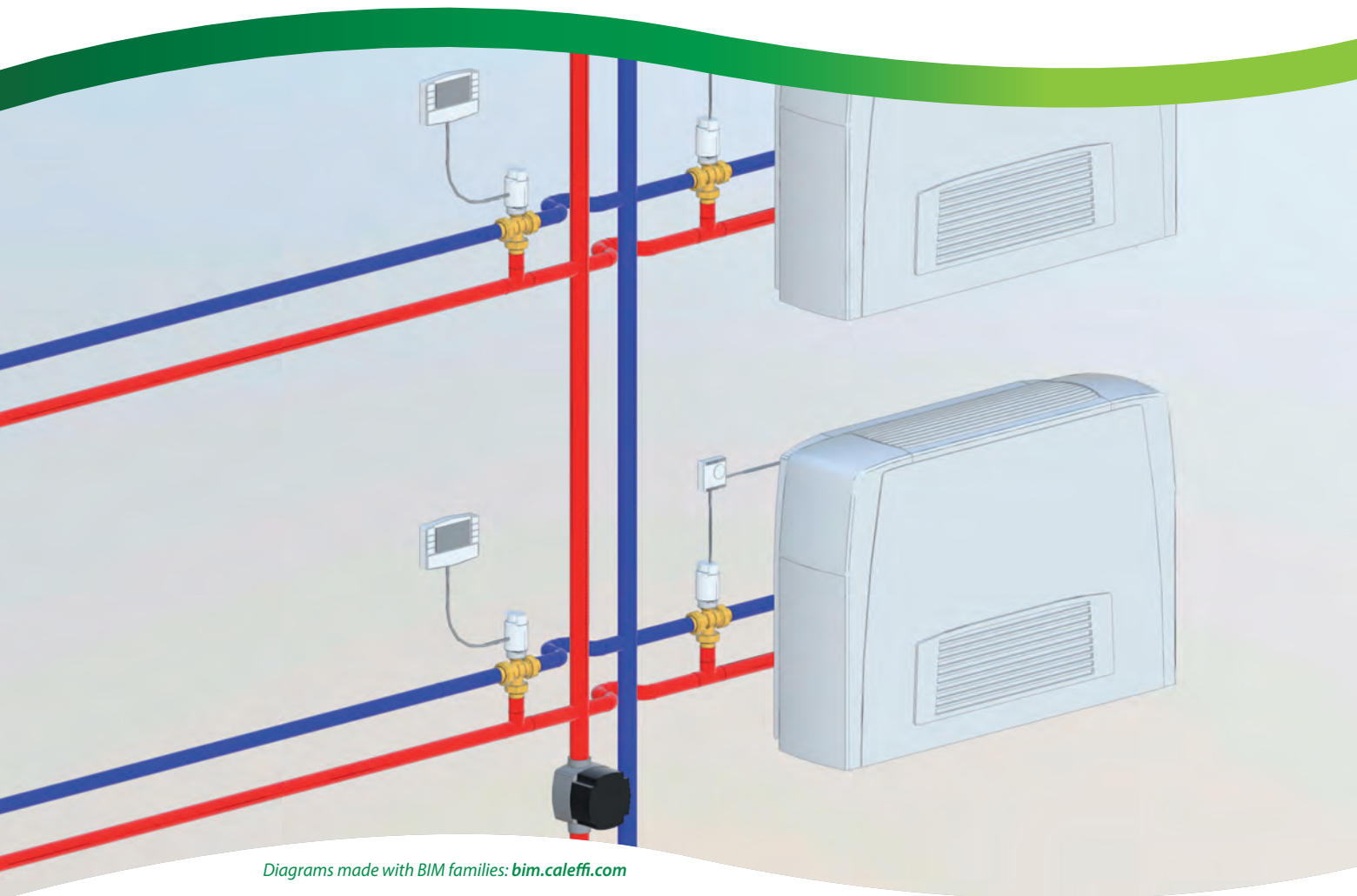

Diagrams made with BIM families: [bim.caleffi.com](http://bim.caleffi.com)

- Expansion vessels**
- Shut-off cocks for expansion vessels**
- Pressure switch and float switch**
- Temperature regulators**
- Thermostats**
- Chrono-thermostats**



**Domestic Water Sizer**   
DOMESTIC WATER SYSTEM SIZER ALSO FOR SMARTPHONE  
Available on [www.caleffi.com](http://www.caleffi.com) and app for smartphone.  
Download the version for your iOS and Android® mobile phone.

## EXPANSION VESSELS FOR HEATING SYSTEMS



### 556

tech. broch. 01079

Welded expansion vessel, for heating systems, EC certification. Diaphragm membrane. Max. working pressure: 6 bar. System working temperature range: -10–120 °C. Membrane working temperature range: -10–70 °C. Max. percentage of glycol: 50 %. Conformity to EN 13831 standard.



Code	Litres	Conn.	Precharge (bar)		
556008	8	3/4"	1,5	1	–
556012	12	3/4"	1,5	1	–
556018	18	3/4"	1,5	1	–
556025	25	3/4"	1,5	1	–



### 556

tech. broch. 01079

Welded expansion vessel, for heating systems, EC certification. Diaphragm membrane. Max. working pressure: 6 bar. System working temperature range: -10–120 °C. Membrane working temperature range: -10–70 °C. Max. percentage of glycol: 50 %. Conformity to EN 13831 standard.



Code	Litres	Conn.	Precharge (bar)		
556035	35	3/4"	1,5	1	–
556050	50	3/4"	1,5	1	–
556080	80	1"	1,5	1	–
556100	100	1"	1,5	1	–
556140	140	1"	1,5	1	–
556200	200	1"	1,5	1	–
556250	250	1"	1,5	1	–



### 556

tech. broch. 01079

Welded expansion vessel, for heating systems, EC certification. Diaphragm membrane. Max. working pressure: 6 bar. System working temperature range: -10–120 °C. Membrane working temperature range: -10–70 °C. Max. percentage of glycol: 50 %. Conformity to EN 13831 standard.



Code	Litres	Conn.	Precharge (bar)		
556300	300	1"	1,5	1	–
556400	400	1"	1,5	1	–
556500	500	1"	1,5	1	–
556600	600	1"	1,5	1	–

## EXPANSION VESSELS FOR HOT WATER SYSTEMS



### 5557



tech. broch. 01079

Welded expansion vessel, for hot water systems, EC certification. Bladder membrane. Max. working pressure: 10 bar. System working temperature range: -10–100 °C. Membrane working temperature range: -10–100 °C. Conformity to EN 13831 standard.



Code	Litres	Conn.	Precharge (bar)		
555702	2	1/2"	2,5	4	–
555705	5	3/4"	2,5	1	–
555708	8	3/4"	2,5	1	–



### 568



tech. broch. 01079

Welded expansion vessel, for hot water systems, EC certification. Bladder membrane. Max. working pressure: 10 bar. System working temperature range: -10–70 °C. Membrane working temperature range: -10–70 °C. Conformity to EN 13831 standard.



Code	Litres	Conn.	Precharge (bar)		
568008	8	3/4"	2,5	1	–
568012	12	3/4"	2,5	1	–
568018	18	3/4"	2,5	1	–
568025	25	3/4"	2,5	1	–
568033*	33	3/4"	2,5	1	–

\* Complete with brackets for wall mounting



### 568



tech. broch. 01079

Welded expansion vessel, for hot water systems, EC certification. Bladder membrane (can be replaced for volumes from 60 to 500 litres). Max. working pressure: 10 bar. System working temperature range: -10–70 °C. Membrane working temperature range: -10–70 °C. Conformity to EN 13831 standard.



Code	Litres	Conn.	Precharge (bar)		
568050	50	1"	2,5	1	–
568060	60	1"	2,5	1	–
568080	80	1"	2,5	1	–
568100	100	1"	2,5	1	–
568200	200	1 1/4"	2,5	1	–
568300	300	1 1/4"	2,5	1	–
568400	400	1 1/4"	2,5	1	–
568500	500	1 1/4"	2,5	1	–

## SHUT-OFF COCK FOR EXPANSION VESSELS



### 558

Automatic shut-off cock, for expansion vessels.  
**For domestic water circuit.**  
 Max. working pressure: 10 bar.  
 Max. working temperature: 110 °C.

Code			
558500	3/4"	1	50



### 558



Automatic shut-off cock, for expansion vessel, with drain cock.  
**For domestic water circuit.**  
 Max. working pressure: 6 bar.  
 Max. working temperature: 85 °C.

Code			
558510	3/4"	1	50



### 5580

Ball shut-off valve, for expansion vessels, with drain cock.  
**For domestic water circuit.**  
 Max. working pressure: 6 bar.  
 Max. working temperature: 85 °C.

Code			
558050	3/4"	1	20
558060	1"	1	20
558070	1 1/4"	1	20

Application diagram of shut-off valve 5580 series

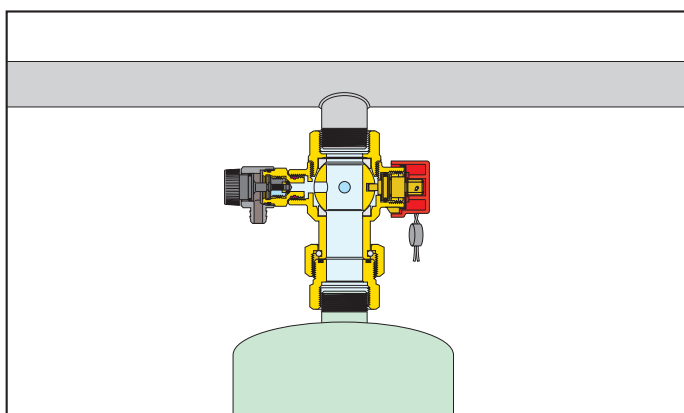



## PRESSURE SWITCH AND FLOAT SWITCH



### 625

Pressure switch for boosting sets and domestic water applications.  
 Up to 500 V three-pole - 16 (10) A.  
 Ambient temperature range: 0–55 °C.  
 Medium temperature range: 0–55 °C.  
 1/4" female connection.  
 Protection class: IP 44.





Code	Setting range	Max. pressure		
625005	1– 5 bar	5 bar	1	10
625010	3–12 bar	12 bar	1	10



### 613

Float switch, 250 V - 10 A.  
 Heavy duty approved.



Code	Cable length		
613030	3 m	1	5
613050	5 m	1	5

TEMPERATURE REGULATOR



161

Digital regulator with synoptic diagram for **heating and cooling** complete with immersion flow probe with pocket and Pt1000 Ø 6 mm return probe (pocket to be chosen according to the pipe; see accessories).  
Optional outside compensated probe.  
Temperature adjustment range: 5–95 °C.  
Supply: 230 V - 50/60 Hz.  
Protection class: IP 20 / EN 60529.  
Probe cable length: 1,5 m.



Code			
161010		1	-



161

Remote regulator.  
Functions:  
- translation of regulation curves,  
- max. temperature,  
- position OFF.

Code			
161005		1	-

Accessories for regulator code 161010.

Code			
161012	Pt1000 contact probe for pipes Ø 6 mm, cable L 2,5 m		
161013	immersion pocket for Pt1000 probe 1/2" M, 60 mm		
161014	immersion pocket for Pt1000 probe 1/2" M, 100 mm		
161015	Pt1000 probe Ø 6 mm - L 20 mm, cable L 1,5 m		
161006	Pt1000 probe Ø 6 mm - L 45 mm, cable L 2,5 m		



161

Outside temperature probe.

Code			
161002		1	-



1520

Digital temperature regulator for **heating and cooling**.  
Complete with flow probe, outside probe and max. relative humidity probe.  
Supply: 230 V - 50/60 Hz.  
Power consumption: 5,5 VA.  
Protection class: IP 40.



Code			
152021	1 channel	1	-



161

Pressure switch with preconnected pin.  
Working range: 0,5–10 bar.  
Max. working temperature: 100 °C.  
Cable length: 1 m.

Code			
161003	1/2"	1	-



1520

Digital temperature regulator for **heating**.  
Complete with flow contact probe and outside probe.  
Adjustment range: 20–90 °C.  
Supply: 230 V - 50/60 Hz.  
Protection class: IP 40.



Code			
152001	1 channel	1	-
152002	2 channels	1	-
152003	3 channels	1	-



161

Dew point detector.  
Working range: 30–100 RH %.

Code			
161004		1	-

THERMOSTATS



620

Room thermostat with changeover switch 16 (2,5) A - 250 V.

620000: without warning lamp.

620100: with warning lamp.

620110: with warning lamp ON/OFF switch.

620120: with warning lamp and SUMMER - WINTER switch.

Protection class: IP 30.

Class: I [Ecodesign Directive].



Code			
620000		1	50
620100		1	50
620110		1	50
620120		1	50



620

Digital room thermostat with display. With changeover contact 5 (3) A. ON/OFF function with adjustable differential from 0,2 to 2 °C or proportional. 2 temperature levels + antifreeze. SUMMER - WINTER switch. Adjustable temperature with 0,1 °C steps. Protection class: IP 30. Class: I [Ecodesign Directive].



Code			
620300	battery supply	1	10
620302	electric supply 230 V	1	10

6205

tech. broch. 01186



Control bar. Supply: 230 V - 50/60 Hz. Power consumption: max. 5,5 VA (8 outputs). Changeover contacts: 10 A. Protection class: IP 30 (with rubber cable clamps). Output command for pump. Input for SUMMER - WINTER. Input for timer.



Code			
620542	4 channels	1	-
620582	8 channels	1	-

CHRONO-THERMOSTATS



618

Digital chrono-thermostat, with battery supply. Daily or weekly programmable clock. 2 temperature levels + antifreeze. Fitted for phone programmer. 30-minute minimum programme. Output contact: 8 (2) A. Protection class: IP 30. Class: I-IV [Ecodesign Directive].



Code			
618101	daily	1	-
618107	weekly	1	-



739

Digital chrono-thermostat, with battery supply. Weekly programmable clock. Quick programming. SUMMER - WINTER changeover. Output contact: 5 (2) A. Protection class: IP 30. Class: I-IV [Ecodesign Directive].



Code			
739107	135 x 90 x 28 mm	1	-



738

Digital room chrono-thermostat with battery electric supply. Backlit display and navigation via menu. Weekly programmable clock. Fitted for phone programmer. 3 temperature levels + antifreeze. 30-minute minimum programme. ON/OFF function with adjustable differential from 0,2 to 2 °C or proportional. SUMMER - WINTER changeover. Adjustable temperature with 0,1 °C steps. Relais output with changeover switch contact: 5 (3) A / 250 V. Protection class: IP 30. Class: I-IV [Ecodesign Directive].



Code			
738407		1	-



738

Digital room chrono-thermostat. Electric supply: 230 V. Backlit display and navigation via menu. Backlit status bar. Weekly programmable clock. Fitted for phone programmer. 3 temperature levels + antifreeze. 30-minute minimum programme. ON/OFF function with adjustable differential from 0,2 to 2 °C or proportional. SUMMER - WINTER changeover. Adjustable temperature with 0,1 °C steps. Relais output with changeover switch contact: 5 (3) A / 250 V. Protection class: IP 30. Class: I-IV [Ecodesign Directive].



Code			
738427		1	-



# HEAT SYSTEMS

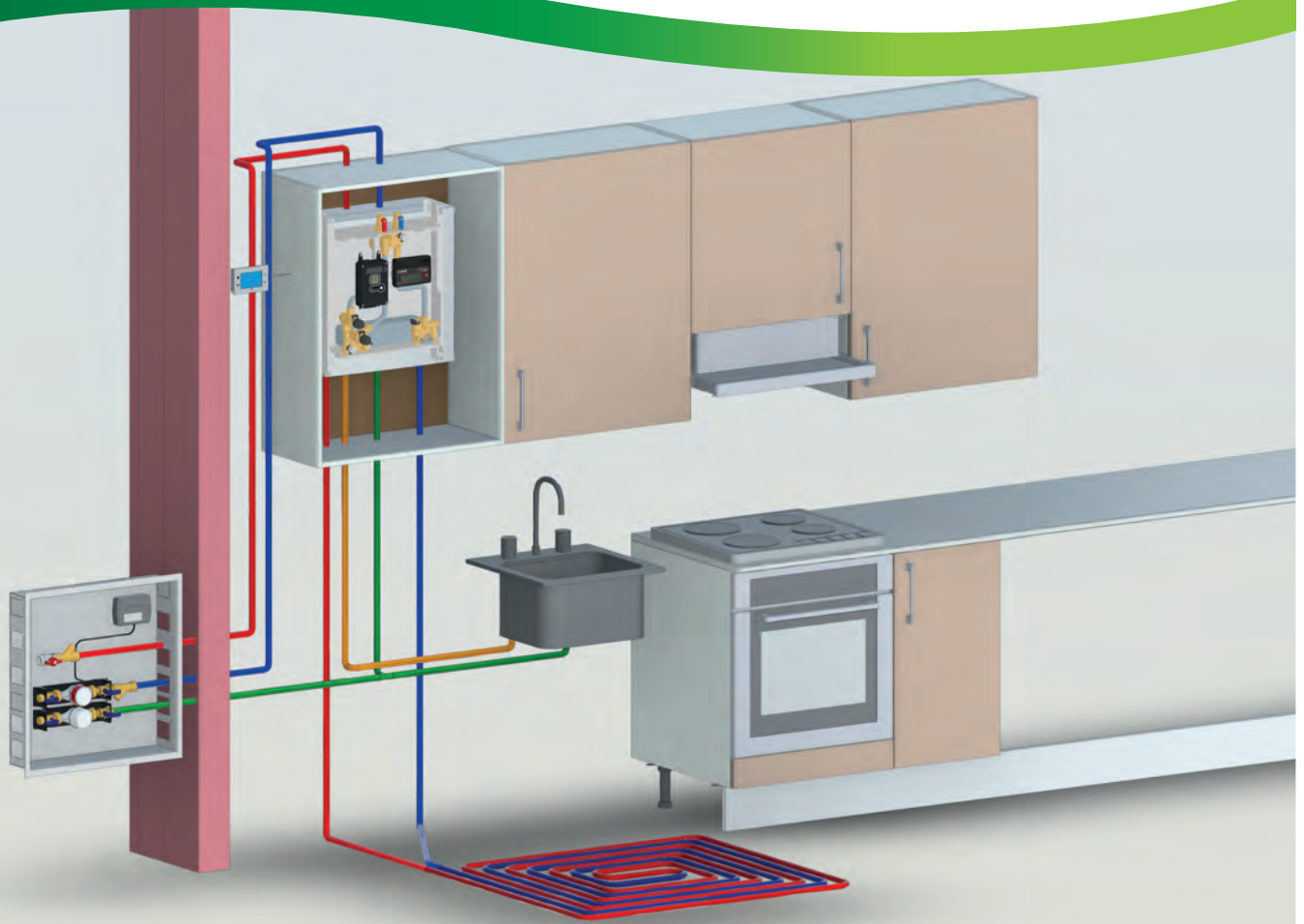

*Diagrams made with BIM families: [bim.caleffi.com](http://bim.caleffi.com)*

## **User modules**

**Wall mounted HIU - Instantaneous DHW production**

**Recess mounted HIU - Instantaneous DHW production**

**PLURIMOD XM SELF BALANCED USER MODULE**

**7004**

tech. broch. 01409

- PLURIMOD XM hydraulic module complete with:
- 2 pairs of 3/4" M ball valves
  - differential pressure control valve with presetting
  - technopolymer template for flow meter
  - inspectable strainer with probe connection
  - technopolymer mounting bracket with thermal break
  - first flushing strainer
  - PPE full insulation.

Fitted for thermo-electric actuators 6565/6566 series.





Code Flow rate range with  $\Delta p_{user}$  15 kPa (m<sup>3</sup>/h)

<b>700475 002</b>	0,04-0,34
<b>700485 002</b>	0,20-1,05

**6565/6566**

Thermo-electric actuator.  
**Quick-coupling installation, with a clip adapter.**  
 Supply: 230 V (AC) o 24 V (AC)/(DC).  
 Control signal: ON/OFF.  
 Power consumption: 1 W.  
 Ambient temperature range: 0-60 °C.  
 Protection class: IP 54.  
 Connection: M 30 p.1,5.  
 Supply cable length: 1 m.



Code	Supply voltage V	Control signal			
<b>656502</b>	230	ON/OFF normally closed		100	-
<b>656504</b>	24	ON/OFF normally closed		100	-
<b>656602</b>	230	ON/OFF normally open		100	-
<b>656604</b>	24	ON/OFF normally open		100	-

**PLURIMOD EASY SELF BALANCED UNIVERSAL USER MODULE CENTRALISED DOMESTIC WATER**

**700205**

tech. broch. 01303



Recessed box with galvanised backplate and RAL 9010 painted door for interior use; finishing frame with adjustable depth from 130 to 160 mm.

- Complete with:
- 2 pairs of 3/4" M ball valves
  - 2 flushing pipes for initial washing of the system. Tmax 55 °C
  - PPE full insulation.
- Fitted for positioning of domestic water functions codes 70005. (see page 320).

Code	Conn.	Dimension (mm)
<b>700205</b>	3/4"	480 x 480

**700025 DUPLEX**

tech. broch. 01113



Recessed box for double PLURIMOD EASY user. Galvanised backplate and RAL 9010 painted door for interior use; finishing frame with adjustable depth from 140 to 180 mm. Equipped with guides for positioning the brackets code 700205 002. Fitted for positioning of domestic water functions codes 70005. (see page 320).

Code	Dimension (mm)
<b>700025</b>	550 x 1175

**700205 003** tech. broch. 01303

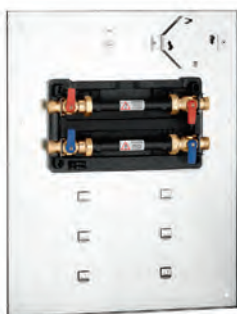

Steel plate for fastening vertically to a wall or for inserting in a services duct. Complete with:

- 2 pairs of 3/4" M ball valves
- 2 flushing pipes for initial washing of the system. Tmax 55 °C
- PPE full insulation.

Fitted for positioning of domestic water functions codes 70005. (see page 320).

Code	Conn.	Dimension (mm)
<b>700205 003</b>	3/4"	480 x 610

**700205 002** tech. broch. 01303



Module bracket for PLURIMOD EASY complete with:

- 2 pairs of 3/4" M ball valves
- 2 flushing pipes for initial washing of the system. Tmax 55 °C
- PPE full insulation.

Code	Conn.
<b>700205 002</b>	3/4"

**7002**

tech. broch. 01303



Hydraulic module PLURIMOD EASY fitted for heat metering. Complete with:

- 2-way zone valve with ON/OFF control by means of thermo-electric actuator 6562 series
- differential valve with user side control with fixed  $\Delta p$
- 2 pockets for temperature probe (flow pocket with stainless steel strainer cartridge)
- 1 copper template for flow meter.

Code	Actuator supply voltage (V)	$\Delta p$ set (kPa)
<b>700215 001</b>	230	15
<b>700216 001</b>	24	15
<b>700217 001</b>	230	20
<b>700218 001</b>	24	20
<b>700219 001</b>	230	30
<b>700220 001</b>	24	30



Copper template for flow meter to replace the plastic template.

Code
<b>R79112</b>



**USER MODULE WITH AUTOMATIC FLOWRATE CONTROL  
CENTRALISED DOMESTIC WATER**

**7003**

Recessed box with galvanised backplate and RAL 9010 painted door for interior use; finishing frame with adjustable depth from 130 to 160 mm.

For both vertical and horizontal installation, inlet possible on both left and right side of the box.

Complete with PLURIMOD EASY ULTRA user module (code 700306 002). Fitted for positioning of domestic water functions codes 70005. (see page 320).



Code	Conn.	Dimension (mm)	Flow rate range (l/h)
700306	1"	480 x 480	180-1800

**7003**

PLURIMOD EASY ULTRA 1" hydraulic module complete with:

- 2 pairs of 1" M ball valves
- PICV DN 25, max. flow rate: 1,8 m³/h
- technopolymer template for flow meter
- inspectable strainer with probe connection
- technopolymer mounting bracket with thermal break
- PPE full insulation.

**Fitted for thermo-electric actuators 6565/6566 series.**



Code	Conn.	Flow rate range (l/h)
700306 002	1"	180-1800

**7003**

Steel plate for fastening vertically to a wall or for inserting in a services duct. Complete with PLURIMOD EASY ULTRA user module (code 700306 002). Fitted for positioning of domestic water functions codes 70005. (see page 320).



Code	Conn.	Dimension (mm)	Flow rate range (l/h)
700306 003	1"	480 x 610	180-1800

**6565/6566**

Thermo-electric actuator.

**Quick-coupling installation, with a clip adapter.**

Supply: 230 V (AC) o 24 V (AC)/(DC).

Control signal: ON/OFF.

Power consumption: 1 W.



Ambient temperature range: 0-60 °C.

Protection class: IP 54.

Connection: M 30 p.1,5.

Supply cable length: 1 m.



Code	Supply voltage V	Control signal			
656502	230	ON/OFF	normally closed	100	-
656504	24	ON/OFF	normally closed	100	-
656602	230	ON/OFF	normally open	100	-
656604	24	ON/OFF	normally open	100	-

**700255 ...**

Hydraulic module fitted for heat metering.

Complete with:

- 1 zone valve unit with flow pocket with strainer mesh
- 1 template for flow meter. Tmax. 55 °C
- 1 pressure independent control valve.

**Fitted for thermo-electric actuators 6565/6566 series.**



Code	Flow rate range (l/h)
700255 H20	20-200
700255 H40	80-400
700255 1H2	120-1200

## PLURIMOD EASY UNIVERSAL USER MODULE CENTRALISED DOMESTIC WATER - WITH DISTRIBUTION MANIFOLD

### 70028

Recessed box for PLURIMOD EASY  
**with distribution manifold for fan-coil systems.**  
Galvanised backplate and RAL 9010 painted door for interior use.



The box is supplied with:  
- 2 pairs of 3/4" M ball valves  
- 2 flushing pipes for initial washing of the system. Tmax 55 °C  
- 2 x 1" distribution manifolds  
**662 series** (max 8 connections).  
Fitted for positioning of domestic water functions codes 70005. (see page 320).

Code	Outlets No.	Outlets	Dimension (mm)
70028B	2	3/4"	866 x 600 x 140-180
70028C	3	3/4"	866 x 600 x 140-180
70028D	4	3/4"	866 x 600 x 140-180
70028E	5	3/4"	866 x 600 x 140-180
70028F	6	3/4"	866 x 600 x 140-180
70028G	7	3/4"	866 x 600 x 140-180
70028H	8	3/4"	866 x 600 x 140-180

### 70029

Recessed box for PLURIMOD EASY  
**with distribution manifold.**  
Galvanised backplate and RAL 9010 painted door for interior use.



The box is supplied with:  
- 2 pairs of 3/4" M ball valves  
- 2 flushing pipes for initial washing of the system. Tmax 55 °C  
- 2 single 3/4" distribution manifolds  
**350 series** (max 8 connections).  
Fitted for positioning of domestic water functions codes 70005. (see page 320).

Code	Outlets No.	Outlets	Dimension (mm)
70029B	2	23 p,1,5	866 x 600 x 140-180
70029C	3	23 p,1,5	866 x 600 x 140-180
70029D	4	23 p,1,5	866 x 600 x 140-180
70029E	5	23 p,1,5	866 x 600 x 140-180
70029F	6	23 p,1,5	866 x 600 x 140-180
70029G	7	23 p,1,5	866 x 600 x 140-180
70029H	8	23 p,1,5	866 x 600 x 140-180

### 70026

Recessed box for PLURIMOD EASY  
**with distribution manifold for radiant panel systems.**  
Galvanised backplate and RAL 9010 painted door for interior use.



The box is supplied with:  
- 2 pairs of 3/4" M ball valves  
- 2 flushing pipes for initial washing of the system. Tmax. 55 °C  
- 2 x 1" distribution manifolds  
**664 series**, flow manifold  
**complete with flow meters and flow rate regulating valve**  
(max 8 connections).  
Fitted for positioning of domestic water functions codes 70005. (see page 320).

Code	Outlets No.	Outlets	Dimension (mm)
70026B	2	3/4"	866 x 600 x 140-180
70026C	3	3/4"	866 x 600 x 140-180
70026D	4	3/4"	866 x 600 x 140-180
70026E	5	3/4"	866 x 600 x 140-180
70026F	6	3/4"	866 x 600 x 140-180
70026G	7	3/4"	866 x 600 x 140-180
70026H	8	3/4"	866 x 600 x 140-180

### 7002

tech. broch. 01303

Hydraulic module PLURIMOD EASY fitted for heat metering.

- Complete with:
- 2-way zone valve with ON/OFF control by means of thermo-electric actuator 6562 series
  - differential valve with user side control with fixed Δp
  - 2 pockets for temperature probe (flow pocket with stainless steel strainer cartridge)
  - 1 copper template for flow meter.



Code	Actuator supply voltage (V)	Δp set (kPa)
700215 001	230	15
700216 001	24	15
700217 001	230	20
700218 001	24	20
700219 001	230	30
700220 001	24	30

For HEAT METERS - HYDRAULIC OPTIONS - see pages 319-320

## PLURIMOD UNIVERSAL USER MODULE CENTRALISED DOMESTIC WATER

### 700005

tech. broch. 01203

Recessed box with galvanised backplate and RAL 9010 painted door for interior use; finishing frame with adjustable depth from 120 to 150 mm.  
Complete with:

- 2 pairs of 3/4" M ball valves
  - 2 flushing pipes for initial washing of the system. Tmax 55 °C.
- Fitted for positioning of domestic water functions codes 70005. (see page 320).



Code	Conn.	Dimension (mm)
700005	3/4"	550 x 550

### 700005 003

Steel plate for fastening vertically to a wall or for inserting in a services duct.

- Complete with:
- 2 pairs of 3/4" M ball valves
  - 2 flushing pipes for initial washing of the system. Tmax 55 °C.
- Fitted for positioning of domestic water functions codes 70005. (see page 312).



Code	Conn.	Dimension (mm)
700005 003	3/4"	480 x 610

### 7000

tech. broch. 01203

Hydraulic module PLURIMOD fitted for heat metering.

- Complete with:
- 1 motorised zone valve
  - 2 pockets for temperature probe
  - 1 copper template for AUTOFLOW®
  - 1 copper template for flow meter
  - insulation.



Code	Actuator supply voltage (V)	Max. recommended flow rate l/h
700015 001	230	1400
700016 001	24	1400

### 700025 DUPLEX

tech. broch. 01113

Recessed box for double PLURIMOD user. Galvanised backplate and RAL 9010 painted door for interior use; finishing frame with adjustable depth from 140 to 180 mm. Equipped with guides for positioning the brackets code 700005 002. Fitted for positioning of domestic water functions codes 70005. (see page 320).



Code	Dimension (mm)
700025	550 x 1175

### 700005 002

Galvanized sheet metal mounting bracket for PLURIMOD plumbing module.

- Complete with:
- 2 pairs of 3/4" M ball valves
  - 2 flushing pipes for initial washing of the system. Tmax 55 °C.



Code
700005 002

### 700075

Compact automatic flow rate regulator. Brass body. Polymer cartridge.

- Max. working pressure: 16 bar.  
Temperature range: 0-100 °C.  
ΔP range: 15-200 kPa.  
Flow rates: 0.12 - 1.40 m³/h.  
Accuracy: ±10 %.



To complete the code, consult the table.  
Example: Maximum required flow rate 600 l/h code 700075 M60.

m³/h	digit	m³/h	digit	m³/h	digit	m³/h	digit	m³/h	digit
0,12	<b>M12</b>	0,25	<b>M25</b>	0,40	<b>M40</b>	0,70	<b>M70</b>	1,00	<b>1M0</b>
0,15	<b>M15</b>	0,30	<b>M30</b>	0,50	<b>M50</b>	0,80	<b>M80</b>	1,20	<b>1M2</b>
0,20	<b>M20</b>	0,35	<b>M35</b>	0,60	<b>M60</b>	0,90	<b>M90</b>	1,40	<b>1M4</b>

Code	1" F captive nut x 1" M
700075 ...	1" F captive nut x 1" M

**For HEAT METERS - HYDRAULIC OPTIONS - see pages 319-320**

**PLURIMOD UNIVERSAL USER MODULE  
CENTRALISED DOMESTIC WATER - WITH DISTRIBUTION MANIFOLD**

**70008**

tech. broch. 01203

Recessed box for PLURIMOD  
**with distribution manifold for fan-coil heating systems.**  
Galvanised backplate and RAL 9010 painted door for interior use.

The box is supplied with:  
- 2 pairs of 3/4" M ball valves  
- 2 flushing pipes for initial washing of the system. Tmax 55 °C  
- 2 x 1" distribution manifolds  
**662 series** (max 8 connections).  
Fitted for positioning of domestic water functions codes 70005. (see page 320).



Code	Outlets No.	Outlets	Dimension (mm)
70008B	2	3/4"	866 x 600 x 140-180
70008C	3	3/4"	866 x 600 x 140-180
70008D	4	3/4"	866 x 600 x 140-180
70008E	5	3/4"	866 x 600 x 140-180
70008F	6	3/4"	866 x 600 x 140-180
70008G	7	3/4"	866 x 600 x 140-180
70008H	8	3/4"	866 x 600 x 140-180

**70009**

tech. broch. 01203

Recessed box for PLURIMOD  
**with distribution manifold for radiator heating systems.**  
Galvanised backplate and RAL 9010 painted door for interior use.

The box is supplied with:  
- 2 pairs of 3/4" M ball valves  
- 2 flushing pipes for initial washing of the system. Tmax 55 °C  
- 2 single 3/4" distribution manifolds  
**350 series** (max 8 connections).  
Fitted for positioning of domestic water functions codes 70005. (see page 320).



Code	Outlets No.	Outlets	Dimension (mm)
70009B	2	23 p.1,5	866 x 600 x 140-180
70009C	3	23 p.1,5	866 x 600 x 140-180
70009D	4	23 p.1,5	866 x 600 x 140-180
70009E	5	23 p.1,5	866 x 600 x 140-180
70009F	6	23 p.1,5	866 x 600 x 140-180
70009G	7	23 p.1,5	866 x 600 x 140-180
70009H	8	23 p.1,5	866 x 600 x 140-180

**70006**

tech. broch. 01203

Recessed box for PLURIMOD  
**with distribution manifold for radiant panel systems.**  
Galvanised backplate and RAL 9010 painted door for interior use.

The box is supplied with:  
- 2 pairs of 3/4" M ball valves  
- 2 flushing pipes for initial washing of the system. Tmax 55 °C  
- 2 x 1" distribution manifolds  
**664 series, flow manifold complete with flow meters and flow rate regulating valve** (max 8 connections).  
Fitted for positioning of domestic water functions codes 70005. (see page 320).



Code	Outlets No.	Outlets	Dimension (mm)
70006B	2	3/4"	866 x 600 x 140-180
70006C	3	3/4"	866 x 600 x 140-180
70006D	4	3/4"	866 x 600 x 140-180
70006E	5	3/4"	866 x 600 x 140-180
70006F	6	3/4"	866 x 600 x 140-180
70006G	7	3/4"	866 x 600 x 140-180
70006H	8	3/4"	866 x 600 x 140-180

**7000**

tech. broch. 01203

Hydraulic module PLURIMOD fitted for heat metering.  
Complete with:  
- 1 motorised zone valve  
- 2 pockets for temperature probe  
- 1 copper template for AUTOFLOW®  
- 1 copper template for flow meter  
- insulation.



Code	Actuator supply voltage (V)	Max. recommended flow rate l/h
700015 001	230	1400
700016 001	24	1400

**For HEAT METERS - HYDRAULIC OPTIONS - see pages 319-320**

**PLURIMOD CLIMA UNIVERSAL USER MODULE - CENTRALISED DOMESTIC WATER**

**700105**

tech. broch. 01210

Recessed box with galvanised backplate and RAL 9010 painted door for interior use; finishing frame with adjustable depth from 120 to 150 mm.

- Complete with:
- 2 pairs of 3/4" M ball valves
  - 2 flushing pipes for initial washing of the system. Tmax 55 °C
  - full insulation.

Fitted for positioning of domestic water functions codes 70005. (see page 320).



Code	Conn.	Dimension (mm)
700105	3/4"	550 x 550

**700105 003**

Steel plate for fastening vertically to a wall or for inserting in a services duct.

- Complete with:
- 2 pairs of 3/4" M ball valves
  - 2 flushing pipes for initial washing of the system. Tmax. 55 °C
  - full insulation.

Fitted for positioning of domestic water functions codes 70005. (see page 320).



Code	Conn.	Dimension (mm)
700105 003	3/4"	480 x 610

**7001**

Hydraulic module PLURIMOD CLIMA fitted for heat metering.

- Complete with:
- 1 zone valve unit with probe pocket
  - 1 servomotor 6450 series, IP 65
  - 1 copper template for AUTOFLOW®
  - 1 copper template for flow meter
  - by-pass adjustment knob.



Code	Actuator supply voltage (V)	Max. recommended flow rate l/h
700115 001	230	1400
700116 001	24	1400

**700025  
DUPLEX**

tech. broch. 01113

Recessed box for double PLURIMOD CLIMA user. Galvanised backplate and RAL 9010 painted door for interior use; finishing frame with adjustable depth from 140 to 180 mm. Equipped with guides for positioning the brackets code 700105 002. Fitted for positioning of domestic water functions codes 70005. (see page 320).



Code	Dimension (mm)
700025	550 x 1175

**700105 002**

Galvanized sheet metal mounting bracket for PLURIMOD CLIMA plumbing module.

- Complete with:
- 2 pairs of 3/4" M ball valves
  - 2 flushing pipes for initial washing of the system. Tmax. 55 °C
  - full insulation.



Code
700105 002

**700075**

Compact automatic flow rate regulator. Brass body. Polymer cartridge. Max. working pressure: 16 bar.

- Temperature range: 0-100 °C.
- ΔP range: 15-200 kPa.
- Flow rates: 0.12 - 1.40 m³/h.
- Accuracy: ±10 %.



To complete the code, consult the table.  
Example: Maximum required flow rate 600 l/h code 700075 M60.

m³/h	digit	m³/h	digit	m³/h	digit	m³/h	digit	m³/h	digit
0,12	<b>M12</b>	0,25	<b>M25</b>	0,40	<b>M40</b>	0,70	<b>M70</b>	1,00	<b>1M0</b>
0,15	<b>M15</b>	0,30	<b>M30</b>	0,50	<b>M50</b>	0,80	<b>M80</b>	1,20	<b>1M2</b>
0,20	<b>M20</b>	0,35	<b>M35</b>	0,60	<b>M60</b>	0,90	<b>M90</b>	1,40	<b>1M4</b>

Code
700075 ... 1" F captive nut x 1" M

**For HEAT METERS - HYDRAULIC OPTIONS - see pages 319-320**

**PRE-ASSEMBLED UNITS FOR PLURIMOD VAN - CENTRALISED DOMESTIC WATER**

**7000**

Pre-assembled unit for positioning in the services duct. It can accommodate 3 complete user systems.

tech. broch. 01113



Unit with 3 outlets for heating and cooling circuits.

Complete with:

- 1 dual 1 1/4" distribution manifold - 3 x 3/4" connections for heating/cooling circuit
- telescopic shut-off valves
- flushing pipes, Tmax. 55 °C
- end plugs
- manifolds insulation (700036)
- full insulation (700136)

**Dimension (w x h x d): 840 x 650 x 160 mm.**

**Circuit template unit for PLURIMOD 7000 series**

Code

**700036** heating

**Circuits template unit for PLURIMOD CLIMA 7001 series**

Code

**700136** heating and cooling

**7000**

tech. broch. 01203

Hydraulic module PLURIMOD fitted for heat metering.

Complete with:

- 1 motorised zone valve
- 2 pockets for temperature probe
- 1 copper template for AUTOFLOW®
- 1 copper template for flow meter
- insulation.



Code	Actuator supply voltage (V)	Max. recommended flow rate l/h
<b>700015 001</b>	230	1400
<b>700016 001</b>	24	1400

**7001**

Hydraulic module PLURIMOD CLIMA fitted for heat metering. Complete with:

- 1 zone valve unit with probe pocket
- 1 servomotor 6450 series, IP 65
- 1 copper template for AUTOFLOW®
- 1 copper template for flow meter
- by-pass adjustment knob.

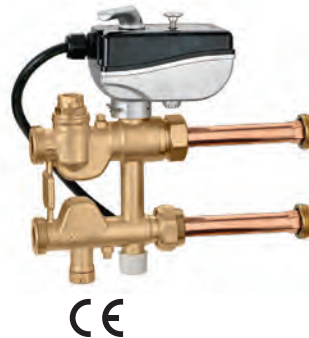

Code	Actuator supply voltage (V)	Max. recommended flow rate l/h
<b>700115 001</b>	230	1400
<b>700116 001</b>	24	1400



Unit with 3 outlets for domestic water circuit.

Complete with:

- 1 simple 1 1/4" distribution manifold - 3 x 3/4" connections, for DHW
- 1 simple 1 1/4" distribution manifold - 3 x 3/4" connections, for DCW
- telescopic shut-off valves
- flushing pipes, Tmax. 55 °C
- end plugs
- manifolds insulation.

**Dimension (w x h x d): 870 x 500 x 240 mm.**

Code

**700037** domestic water circuit template unit

**For HEAT METERS - HYDRAULIC OPTIONS - see pages 319-320**

**DIRECT SUPPLY UNITS**



**765**  [tech. broch. 01215](#)  
 Direct supply unit for **heating and cooling systems**.  
**With pre-formed insulation.**  
 Template for flow meter.  
 Connections for direct immersion probes.  
 Max. working pressure: 10 bar.  
 Max. working temperature: 100 °C.  
 Electric supply: 230 V - 50 Hz.  
 System syde conection: 1" F.  
 Boiler side connection: 1 1/2" M.  
 Centre distance: 125 mm.



**Reversible RH-LH**

Code	Pump	Flow rate with residual prevalence 4 m w.g.
765600HE	PARA 25/9	2,5 m³/h

**MOTORISED REGULATING UNITS**



**767**  [tech. broch. 01215](#)  
 Motorised regulating unit for **heating systems and cooling systems**.  
**With pre-formed insulation.**  
 Template for flow meter.  
 Connections for direct immersion probes.  
 Regulation with sector three-way valve.  
 Can be connected to digital regulators code 161010.  
 Max. working pressure: 10 bar.  
 Max. working temperature: 100 °C.  
 Electric supply: 230 V - 50 Hz.  
 System side connection: 1" F.  
 Boiler side connection: 1 1/2" M.  
 Centre distance: 125 mm.



**Reversible RH-LH**

**Actuator with 3-point control signal - 230 V supply voltage**

Code	Pump	Flow rate with residual prevalence 4 m w.g.
767662HE2	PARA 25/9	2,2 m³/h

**Actuator with 0(2)-10 V control signal - 24 V supply voltage**

Code	Pump	Flow rate with residual prevalence 4 m w.g.
767664HE2	PARA 25/9	2,2 m³/h

**THERMOSTATIC REGULATING UNITS**



**766**  [tech. broch. 01215](#)  
 Thermostatic regulating unit for **heating systems**.  
**With pre-formed insulation.**  
 Template for flow meter.  
 Connections for direct immersion probes.  
 Max. working pressure: 10 bar.  
 Temperature adjustment range: 25-50 °C.  
 Primary inlet temperature: 100 °C.  
 Electric supply: 230 V - 50 Hz.  
 System syde conection: 1" F.  
 Boiler side connection: 1 1/2" M.  
 Centre distance: 125 mm.



**Reversible RH-LH**

Code	Pump	Flow rate with residual prevalence 4 m w.g.
766600HE	PARA 25/9	2,1 m³/h

**REGULATOR**



**161**  
 Digital regulator with synoptic diagram for heating and cooling complete with immersion flow probe with pocket and Pt1000 Ø 6 mm return probe (pocket to be chosen according to the pipe; see accessories).  
 Optional outside compensated probe.  
 Temperature adjustment range: 5-95 °C.  
 Supply: 230 V - 50/60 Hz.  
 Control signal: 3 points, 0-10 V.  
 Protection class: IP 20 / EN 60529.  
 Probe cable length: 1,5 m.



Code
161010

2-WAY USER MODULE - WITH AUTOFLOW® - CENTRALISED DOMESTIC WATER

799 series

tech. broch. 01103

2-way user module with AUTOFLOW®

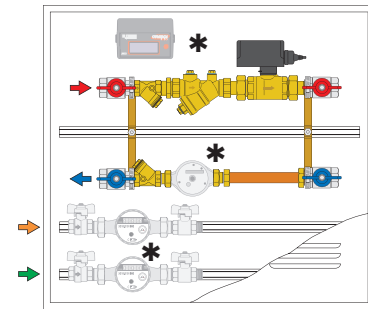

- Zone outlet** module complete with:
- Recessed box with galvanised backplate and RAL 9010 painted door for interior use, h = 650 mm, depth = 110 (140) mm
  - pair of ball shut-off
  - two-way ball zone valve 6470 series and servomotor 6460 series
  - air vent 5021 series
  - AUTOFLOW®
  - 3/4" and 1" simple manifold 350 series, 1 1/4" manifold 650 series
  - template for heat meter
  - probe holder pocket (flow pocket with strainer mesh)
  - connections for domestic water function 794. series.

**AUTOFLOW® flow rate table**

... To complete the code, please consult the table below:

7995. series  
79005. series  
(3/4")

with Δp range 15–200 kPa			
m³/h	... digit	m³/h	... digit
0,30	M30	0,90	M90
0,40	M40	1,00	1M0
0,50	M50	1,20	1M2
0,60	M60	1,40	1M4
0,70	M70		
0,80	M80		

7996. series  
79006. series  
(1")

with Δp range 15–200 kPa			
m³/h	... digit	m³/h	... digit
0,60	M60	1,40	1M4
0,70	M70	1,60	1M6
0,80	M80	1,80	1M8
0,90	M90	2,00	2M0
1,00	1M0	2,25	2M2
1,20	1M2		

7997. series  
79007. series  
(1 1/4")

with Δp range 15–200 kPa			
m³/h	... digit	m³/h	... digit
1,00	1M0	2,25	2M2
1,20	1M2	2,50	2M5
1,40	1M4	2,75	2M7
1,60	1M6	3,00	3M0
1,80	1M8	3,25	3M2
2,00	2M0	3,50	3M5

Code	Outlets	End conn.	Outlets conn.	Width (mm)
799560 ...	without manifolds	3/4"	-	600
79956B ...	2	3/4"	23 p.1,5	800
79956C ...	3	3/4"	23 p.1,5	800
79958D ...	4	3/4"	23 p.1,5	800
79958E ...	5	3/4"	23 p.1,5	800
79958F ...	6	3/4"	23 p.1,5	1.000
79958G ...	7	3/4"	23 p.1,5	1.000
79951H ...	8	3/4"	23 p.1,5	1.000
799660 ...	without manifolds	1"	-	600
79968C ...	3	1"	23 p.1,5	800
79968D ...	4	1"	23 p.1,5	800
79968E ...	5	1"	23 p.1,5	800
79961F ...	6	1"	23 p.1,5	1.000
79961G ...	7	1"	23 p.1,5	1.000
79961H ...	8	1"	23 p.1,5	1.000
79961I ...	9	1"	23 p.1,5	1.000
79962L ...	10	1"	23 p.1,5	1.200
799780 ...	without manifolds	1 1/4"	-	800
79978C ...	3	1 1/4"	3/4"	800
79978D ...	4	1 1/4"	3/4"	800
79971E ...	5	1 1/4"	3/4"	1.000
79971F ...	6	1 1/4"	3/4"	1.000
79971G ...	7	1 1/4"	3/4"	1.000
79972H ...	8	1 1/4"	3/4"	1.200
79972I ...	9	1 1/4"	3/4"	1.200
79972L ...	10	1 1/4"	3/4"	1.200

\* For HEAT METERS - HYDRAULIC OPTIONS - INSULATION see pages 319-320-321  
The colours that identify the connection diameter are a guide to help find the corresponding heat meter, see pages 319



3-WAY USER MODULE - CENTRALISED DOMESTIC WATER

796 series

tech. broch. 01101

3-way user module

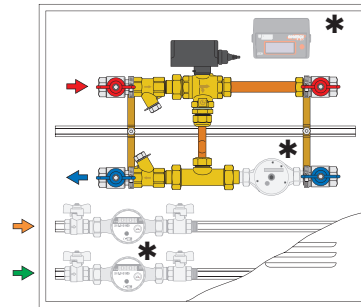
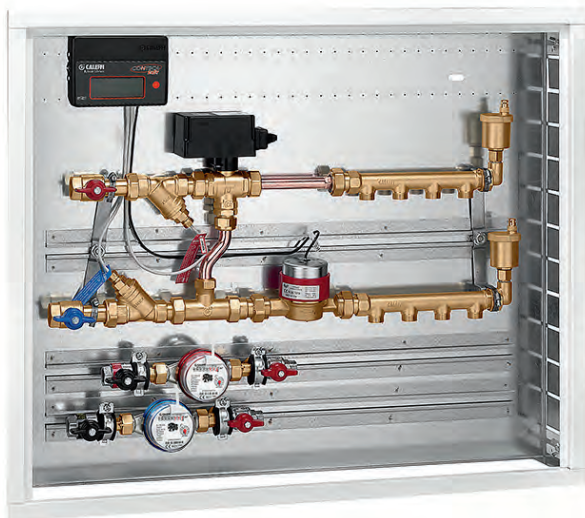

Code	Outlets	End conn.	Outlets conn.	Width (mm)
796560	without manifolds	3/4"	-	600
79658B	2	3/4"	23 p,1,5	800
79658C	3	3/4"	23 p,1,5	800
79658D	4	3/4"	23 p,1,5	800
79658E	5	3/4"	23 p,1,5	800
79658F	6	3/4"	23 p,1,5	1.000
79651G	7	3/4"	23 p,1,5	1.000
79651H	8	3/4"	23 p,1,5	1.000

796680	without manifolds	1"	-	800
79661C	3	1"	23 p,1,5	1.000
79661D	4	1"	23 p,1,5	1.000
79661E	5	1"	23 p,1,5	1.000
79661F	6	1"	23 p,1,5	1.000
79662G	7	1"	23 p,1,5	1.200
79662H	8	1"	23 p,1,5	1.200
79662I	9	1"	23 p,1,5	1.200
79662L	10	1"	23 p,1,5	1.200

796780	without manifolds	1 1/4"	-	800
79671C	3	1 1/4"	3/4"	1.000
79671D	4	1 1/4"	3/4"	1.000
79672E	5	1 1/4"	3/4"	1.200
79672F	6	1 1/4"	3/4"	1.200
79672G	7	1 1/4"	3/4"	1.200
79672H	8	1 1/4"	3/4"	1.200

Zone outlet module complete with:

- Recessed box with galvanised backplate and RAL 9010 painted door for interior use, h = 650 mm, depth = 110 (140) mm
- pair of ball shut-off
- three-way ball zone valve 6480 series with by-pass tee 6490 series and servomotor 6460 series
- air vent 5021 series
- 3/4" and 1" simple manifold 350 series, 1 1/4" manifold 650 series
- template for heat meter
- probe holder pocket (flow pocket with strainer mesh)
- connections for domestic water function 794. series.

Spare wall box

R79674	600 x 650 x 110/140 mm
R79675	800 x 650 x 110/140 mm
R79676	1000 x 650 x 110/140 mm
R79677	1200 x 650 x 110/140 mm
R79088	800 x 650 x 150/175 mm

\* For HEAT METERS - HYDRAULIC OPTIONS - INSULATION see pages 319-320-321  
The colours that identify the connection diameter are a guide to help find the corresponding heat meter, see pages 319

**COMPACT WALL MOUNTED DIRECT HEAT INTERFACE UNIT  
INSTANTANEOUS DHW PRODUCTION - SATK20 - SATK22 SERIES**

**LOW TEMPERATURE**



**SATK201** tech. broch. 01209  
 LOW temperature HIU.  
 Heating temperature range: 25–45 °C.  
 Max. 18 l/min DHW.  
 Max. operating pressure: 10 bar.  
 Max. primary Δp: 0,9 bar.  
**Dimensions (w x h x d):**  
 450 x 550 x 265 mm.



Code

**SATK20103HE** heat exchanger 40 kW

**MEDIUM TEMPERATURE**



**SATK202** tech. broch. 01209  
 MEDIUM temperature HIU.  
 Heating temperature range: 45–75 °C.  
 Max. 18 l/min DHW.  
 Max. operating pressure: 10 bar.  
 Max. primary Δp: 0,9 bar.  
**Dimensions (w x h x d):**  
 450 x 550 x 265 mm.



Code

**SATK20203HE** heat exchanger 40 kW



**SATK221** tech. broch. 01309  
 LOW temperature HIU.  
 Heating temperature range: 25–45 °C.  
 Max. 24 l/min DHW.  
 Max. operating pressure: 10 bar.  
 Max. primary Δp: 6 bar.  
 User interface with chrono-thermostat function.  
 Programmable DHW pre-heating.  
 Remote control via MODBUS-RTU.  
**Dimensions (w x h x d):**  
 490 x 500 x 245 mm.



Code

**SATK22103** heat exchanger 50 kW

**SATK22105** heat exchanger 60 kW

**SATK22107** for systems with low primary temperature



**SATK222** tech. broch. 01309  
 MEDIUM temperature HIU.  
 Heating temperature range: 45–75 °C.  
 Max. 24 l/min DHW.  
 Max. operating pressure: 10 bar.  
 Max. primary Δp: 6 bar.  
 User interface with chrono-thermostat function.  
 Programmable DHW pre-heating.  
 Remote control via MODBUS-RTU.  
**Dimensions (w x h x d):**  
 490 x 500 x 245 mm.



Code

**SATK22203** heat exchanger 50 kW

**SATK22205** heat exchanger 60 kW

**SATK22207** for systems with low primary temperature

Hydraulic diagram SATK201/SATK221

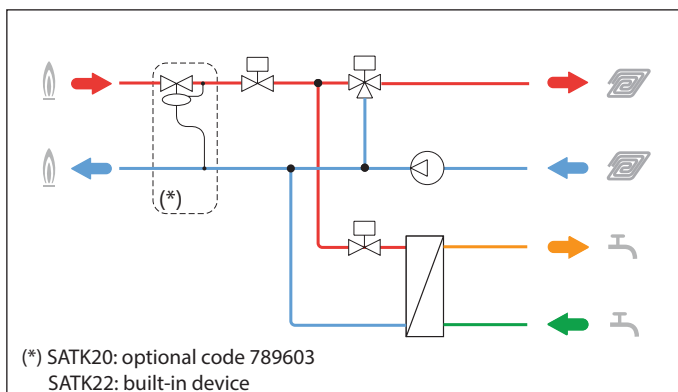

Hydraulic diagram SATK202/SATK222

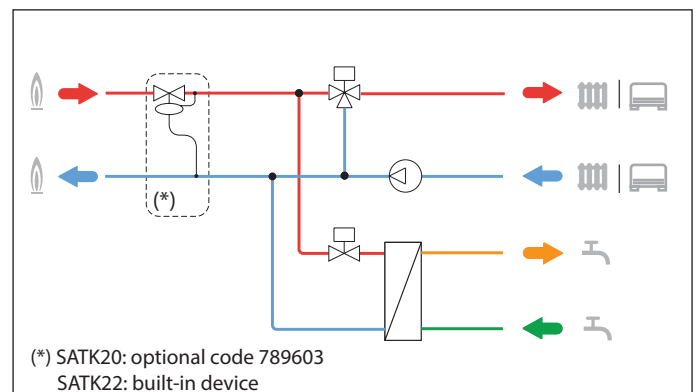

**COMPACT WALL MOUNTED DIRECT HEAT INTERFACE UNIT  
INSTANTANEOUS DHW PRODUCTION - SATK20 - SATK22 SERIES**

**HIGH TEMPERATURE**

**SATK203** tech. broch. 01209



HIGH temperature HIU.  
Max. heating temperature: 85 °C.  
Max. 18 l/min DHW (SATK20303).  
Max. 27 l/min DHW (SATK20305).  
Max. operating pressure: 10 bar.  
Max. primary Δp: 0,9 bar.  
**Dimensions (w x h x d):**  
**450 x 550 x 265 mm.**



Code

<b>SATK20303</b>	heat exchanger 40 kW
<b>SATK20305</b>	heat exchanger 65 kW

**HIGH TEMPERATURE-WITH PRIMARY PUMP**

**SATK204** tech. broch. 01209



HIGH temperature HIU.  
Max. heating temperature: 85 °C.  
Max. 18 l/min DHW.  
Max. operating pressure: 10 bar.  
Max. primary Δp: 0,9 bar.  
With primary pump.  
**Dimensions (w x h x d):**  
**450 x 550 x 265 mm.**



Code

<b>SATK20403HE</b>	heat exchanger 40 kW
--------------------	----------------------

**SATK223** tech. broch. 01309



HIGH temperature HIU.  
Max. heating temperature: 85 °C.  
Max. 24 l/min DHW.  
Max. operating pressure: 10 bar.  
Max. primary Δp: 6 bar.  
User interface with chrono-thermostat function.  
Programmable DHW pre-heating.  
Remote control via MODBUS-RTU.  
**Dimensions (w x h x d):**  
**490 x 500 x 245 mm.**



Code

<b>SATK22303</b>	heat exchanger 50 kW
<b>SATK22305</b>	heat exchanger 60 kW
<b>SATK22307</b>	for systems with low primary temperature

**SATK224** tech. broch. 01309



HIGH temperature HIU.  
Max. heating temperature: 85 °C.  
Max. 24 l/min DHW.  
Max. operating pressure: 10 bar.  
Max. primary Δp: 6 bar.  
With primary pump.  
User interface with chrono-thermostat function.  
Programmable DHW pre-heating.  
Remote control via MODBUS-RTU.  
**Dimensions (w x h x d):**  
**490 x 500 x 245 mm.**



Code

<b>SATK22403</b>	heat exchanger 50 kW
<b>SATK22405</b>	heat exchanger 60 kW
<b>SATK22407</b>	for systems with low primary temperature

Hydraulic diagram SATK203/SATK223

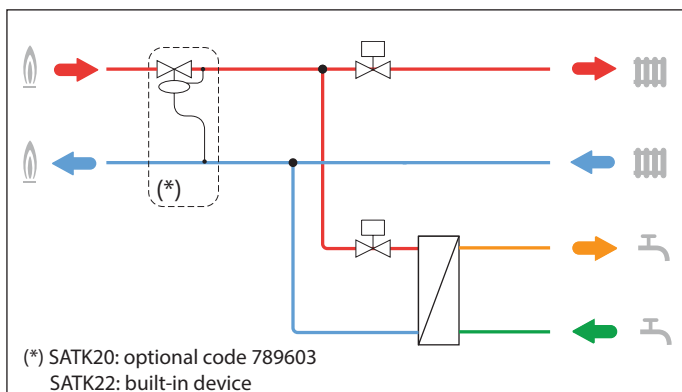

Hydraulic diagram SATK204/SATK224

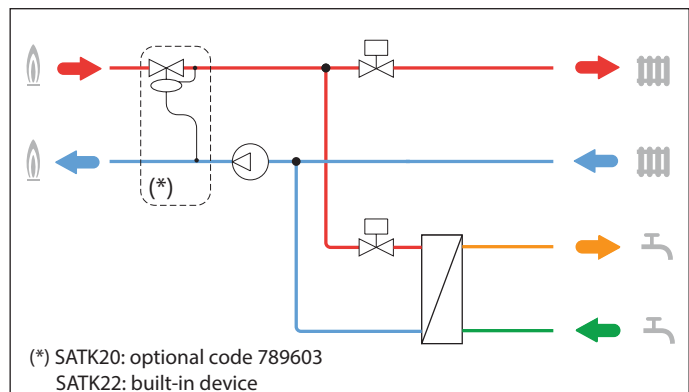

**COMPACT WALL MOUNTED INDIRECT HEAT INTERFACE UNIT  
SATK30 - SATK32 - SATK40 SERIES**

**LOW/MEDIUM/HIGH TEMPERATURE**



**SATK30** tech. broch. 01209

LOW temperature range: 25–45 °C.  
Medium/high temperature range: 45–75 °C.  
Max. 18 l/min DHW (SATK30103HE).  
Max. 27 l/min DHW (SATK30105HE).  
Max. operating pressure: 16 bar.  
Max. primary Δp: 1,65 bar.  
**Dimensions (w x h x d):**  
**550 x 630 x 265 mm.**



Code

<b>SATK30103HE</b>	heat exchanger 40 kW
<b>SATK30105HE</b>	heat exchanger 65 kW

**LOW/MEDIUM/HIGH TEMPERATURE  
STORAGE DHW PRODUCTION**



**SATK40** tech. broch.01216

LOW temperature range: 25–45 °C.  
Medium/high temperature range: 45–75 °C.  
Max. operating pressure: 16 bar.  
Max. primary Δp: 1,5 bar.  
DHW production in storage cylinder (not supplied).  
**Dimensions (w x h x d):**  
**550 x 630 x 265 mm.**



Code

<b>SATK40103HE</b>
--------------------



**SATK32** tech. broch. 01301

LOW temperature range: 25–45 °C.  
Medium/high temperature range: 45–75 °C.  
Max. 24 l/min DHW.  
Max. operating pressure: 16 bar.  
Max. primary Δp: 6 bar.  
User interface with chrono-thermostat function.  
Programmable DHW pre-heating.  
Remote control via MODBUS-RTU.  
**Dimensions (w x h x d):**  
**490 x 630 x 245 mm.**



Code

<b>SATK32103</b>	heat exchanger 50 kW
<b>SATK32105</b>	heat exchanger 60 kW
<b>SATK32107</b>	for systems with low primary temperature

**Hydraulic diagram SATK40**

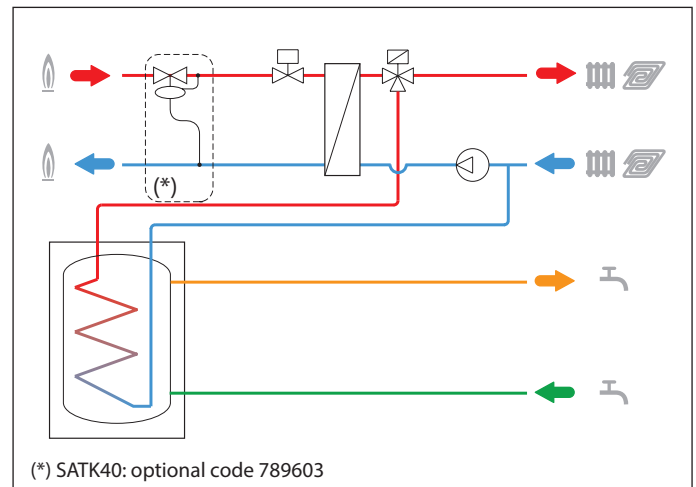

**Hydraulic diagram SATK301/SATK321**

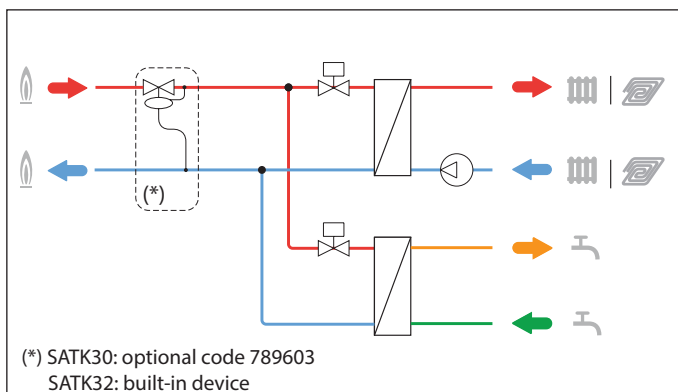

COMPLETION CODES FOR SATK SERIES



**789100**

Manual flushing by-pass for SATK20, SATK30 and SATK40. System side connection: 3/4" M. User side connection: 3/4" M.

Code

**789100**



**789110**

Manual flushing by-pass for SATK22 and SATK32. System side connection: 3/4" F. User side connection: 3/4" M.

Code

**789110**



**572120**

Filling loop with CB type backflow preventer for SATK32.

Code

**572120**



**789833**

Outside temperature probe for SATK22 and SATK32.

Code

**789833**



**789**

Differential pressure control valve. For SATK20, SATK30 and SATK40. Brass body. Max working pressure: 16 bar. Max. upstream Δp: 6 bar. Fixed setting: 40 kPa.

Code

**789603**



**789023**

Mounting template with shut-off valve for SATK22 and SATK32.

Code

**789023**



**794540**

Template for domestic water meter with:  
- ball shut-off valve with built-in check valve BALLSTOP  
- flushing pipe.  
For SATK20, SATK30, SATK40, SATK50 and SATK60

Code

**794540** 3/4"



**789832**

Drain conveyor pipe for SATK32

Code

**789832** 3/4"

DHW ONLY HEAT INTERFACE UNIT - SATK10 SERIES



**SATK10** tech. broch. 01308

Domestic hot water production only.  
Max. 27 l/min DHW.  
Max. operating pressure: 10 bar.  
Max. primary Δp: 0,9 bar.  
**Dimensions (w x h x d):**  
**476 x 350 x 188 mm.**

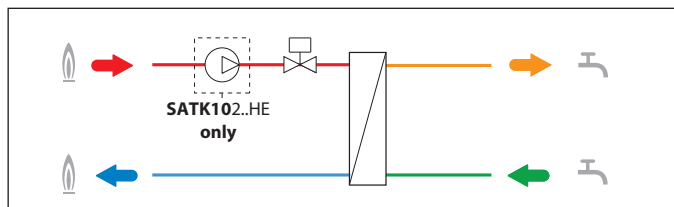

Code

Max. flow rate

<b>SATK10203HE</b>	heat exchanger 40 kW	18 (l/min)
<b>SATK10204HE</b>	heat exchanger 65 kW	25 (l/min)
<b>SATK10205HE</b>	heat exchanger 75 kW	27 (l/min)

**Without primary pump**

Code

Max. flow rate

<b>SATK10253</b>	heat exchanger 40 kW	18 (l/min)
<b>SATK10254</b>	heat exchanger 65 kW	25 (l/min)
<b>SATK10255</b>	heat exchanger 75 kW	27 (l/min)

**COMPACT WALL MOUNTED INDIRECT HEAT INTERFACE UNIT - MECHANICAL VERSIONS  
INSTANTANEOUS DHW PRODUCTION - SATK15 - SATK16 SERIES**

**SATK15**

tech. broch. 01407

Heating and DHW production. Modulating primary control.  
With DPCV on the primary side, fixed setting 30 kPa.  
Max. operating pressure: 10 bar.  
Max. primary Δp: 2 bar.  
Connections: 3/4" M.

**Dimensions (w x h x d): 420 x 223 x 143 mm. (SATK15324 DPCV)**  
**Dimensions (w x h x d): 420 x 223 x 169 mm. (SATK15325 DPCV)**

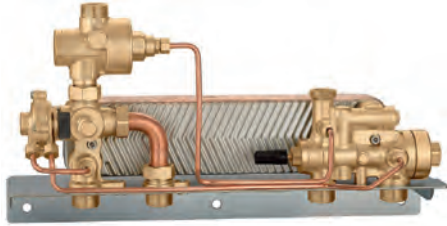

Code

<b>SATK15324 DPCV</b>	heat exchanger 40 kW
<b>SATK15325 DPCV</b>	for systems with low primary temperature

**SATK16**

tech. broch. 01359

Heating and DHW production. Modulating primary control.  
With DPCV on the primary side, fixed setting 30 kPa.  
With heating zone valve and thermostatic mixing valve on DHW outlet.  
Max. operating pressure: 10 bar.  
Max. primary Δp: 2 bar.  
Connections: 3/4" M.  
**Dimensions (w x h x d): 420 x 450 x 200 mm.**



Code

<b>SATK16315</b>	for systems with low primary temperature
------------------	--

**SATK15**

tech. broch. 01407

Heating and DHW production. Modulating primary control.  
With DPCV on the primary side, fixed setting 30 kPa.  
Max. operating pressure: 10 bar.  
Max. primary Δp: 2 bar.  
Connections: 3/4" M.

**Dimensions (w x h x d): 570 x 260 x 143 mm. (SATK15324 ABC)**  
**Dimensions (w x h x d): 570 x 260 x 169 mm. (SATK15325 ABC)**

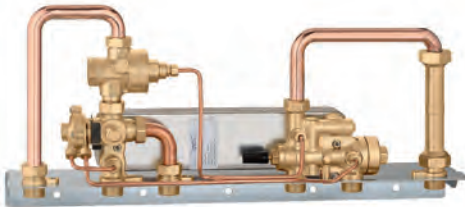

Code

<b>SATK15324 ABC</b>	heat exchanger 40 kW
<b>SATK15325 ABC</b>	for systems with low primary temperature

**NEW**

**789**

Pre-formed insulation for SATK15 series.



Code Use

<b>789323</b>	SATK15324 DPCV
<b>789325</b>	SATK15325 DPCV
<b>789314</b>	SATK1532. ABC

**COOLING INTERFACE UNIT**



**797**

tech. broch. 01368

Cooling interface unit.  
Max. primary circuit pressure: 16 bar.  
Primary circuit nominal flow rate:  
360 l/h (797601)  
1080 l/h (797603)  
1800 l/h (797605)  
Max. primary Δp: 4 bar.  
Connections: 1".  
**Dimensions (w x h x d): 480 x 780 x 220 mm.**

Code Nominal power

<b>797601</b>	3 kW*
<b>797603</b>	8 kW*
<b>797605</b>	15 kW*

(\*) primary 6–12 °C, secondary 14–8 °C

**COMPACT RECESS MOUNTED DIRECT HEAT INTERFACE UNIT  
INSTANTANEOUS DHW PRODUCTION - SATK50 SERIES**

**LOW TEMPERATURE**

**SATK501** tech. broch. 01212

LOW temperature HIU.  
Heating temperature range: 25–45 °C.  
Max. 18 l/min DHW.  
Max. operating pressure: 10 bar  
Max. primary Δp: 0,9 bar.  
**Dimensions (w x h x d):  
570 x 410 x 110 mm.**



Code	
<b>SATK50103HE</b>	heat exchanger 40 kW

**LOW temperature recessed module (for installation without box code 794950)**

with features identical to SATK50103HE.  
Ideal for on-site solutions, to give functional continuity to user modules with similar connections and features. 1" M connection with flat seat.  
Ball shut-off valves not included.  
**Valve kit F0001495 must be used.**

Code	
<b>SATK50193HE</b>	heat exchanger 40 kW
<b>SATK50193HE 001</b>	heat exchanger 40 kW with insulation cover

**MEDIUM TEMPERATURE**

**SATK502** tech. broch. 01212

MEDIUM temperature HIU.  
Heating temperature range: 45–75 °C.  
Max. 18 l/min DHW.  
Max. operating pressure: 10 bar.  
Max. primary Δp: 0,9 bar.  
**Dimensions (w x h x d):  
570 x 410 x 110 mm.**



Code	
<b>SATK50203HE</b>	heat exchanger 40 kW

**MEDIUM temperature recessed module (for installation without box code 794950)**

with features identical to SATK50203HE.  
Ideal for on-site solutions, to give functional continuity to user modules with similar connections and features. 1" M connection with flat seat.  
Ball shut-off valves not included.  
**Valve kit F0001495 must be used.**

Code	
<b>SATK50293HE</b>	heat exchanger 40 kW

**HIGH TEMPERATURE**

**SATK503** tech. broch. 01212

HIGH temperature HIU.  
Max. heating temperature: 85 °C.  
Max. 18 l/min DHW.  
Max. operating pressure: 10 bar.  
Max. primary Δp: 0,9 bar.  
**Dimensions (w x h x d):  
570 x 410 x 110 mm.**



Code	
<b>SATK50303</b>	heat exchanger 40 kW

**HIGH temperature recessed module (for installation without box code 794950)**

with features identical to SATK50303.  
Ideal for on-site solutions, to give functional continuity to user modules with similar connections and features. 1" M connection with flat seat. Ball shut-off valves not included.  
**Valve kit F0001495 must be used.**

Code	
<b>SATK50393</b>	heat exchanger 40 kW
<b>SATK50393 001</b>	heat exchanger 40 kW with insulation cover

**ACCESSORIES**

**7949** tech. broch. 01212

Recessed mounting box for SATK50.03HE, complete with shut-off valves for preliminary connections to the system.



Code	Dimensions (w x h x d)
<b>794950</b>	600 x 700 x 120 mm

**Modules SATK50193HE, SATK50293HE and SATK50393 can be installed without box code 794950 as they have a specific locking template. Shut-off valves are required for every periodic or non-periodic maintenance operation and for system safety in general. Product code F00001495 may be used; this includes 6 x 3/4" M-1" F ball valves with with captive nut connection and relevant seals.**

Code	
<b>F0001495</b>	valve kit for SATK50.93HE/SATK60193HE

**COMPACT RECESS INDIRECT HEAT INTERFACE UNIT  
INSTANTANEOUS DHW PRODUCTION - SATK60 SERIES**

**LOW/MEDIUM/HIGH TEMPERATURE**



**SATK60** tech. broch. 01212

LOW heating temperature range: 25–45 °C.  
MEDIUM/HIGH heating temperature range: 45–75 °C.  
Max. 18 l/min DHW.  
Max. operating pressure: 16 bar.  
Max. primary Δp: 0,9 bar.  
**Dimensions (w x h x d):**  
570 x 410 x 110 mm.



**7949** tech. broch. 01212

Recessed mounting box for SATK60, complete with shut-off valves for preliminary connections to the system.

**Note**  
Box code 794960 is compulsory for the installation of product code SATK60103HE..

Code

<b>SATK60103HE</b>	heat exchanger 40 kW
<b>SATK60193HE</b>	with locking template

Code Dimensions (w x h x d)

<b>794960</b>	625 x 890 x 120 mm
---------------	--------------------

**SATK60103HE**

**794960**

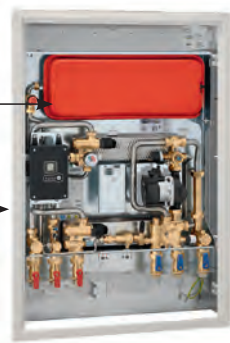

**Note**  
Box code 794960 is compulsory for the installation of product code SATK60103HE.



Ball shut-off valve kit complete with:  
- ball valve with 1" nut  
- fibre sealing gasket  
- red/blue control levers

Maximum working pressure: 10 bar.  
Working temperature range: 5–90 °C.  
Medium: water and glycol solutions, max. 30 %.

Codice Utilizzo

<b>F0001495</b>	SATK50.93HE/SATK60193HE
-----------------	-------------------------

Module code SATK60193HE can be installed without box code 794960 as it has a specific locking template. Shut-off valves are required for every periodic or non-periodic maintenance operation and for system safety in general. Product code F00001495 may be used; this includes 6 x 3/4" M–1"F ball valves with connection with captive nut and the relevant seals.

**Hydraulic diagram SATK60**

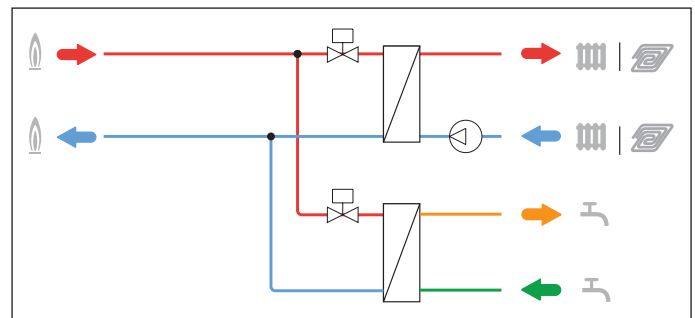



**DIRECT HEAT METER - CENTRALISED TRANSMISSION - BUS RS-485**

**CONTECA EASY 7504 series**

tech. broch. 01306

Direct heat metering with local reading by means of LCD or centralised reading by means of Bus transmission.

The heat meter is supplied with:

- Pair of immersion temperature probe (L= 1,9 m).
- Turbine flow meter with pulse output (Tmax 90 °C).
- Electronic integrator with LCD.
- Accuracy class: 3.

- **Electric supply 24 V (AC) 50 Hz - 1 W.**

**Fitted for Bus RS-485 transmission in M-Bus protocol.**

Optional MODBUS-RTU.

**7504**

Direct heat meter (MI004) for user modules 796, 799, 7900 series. Flow meter with union connections. Pair of Y-pockets (with strainer on the flow one) included.

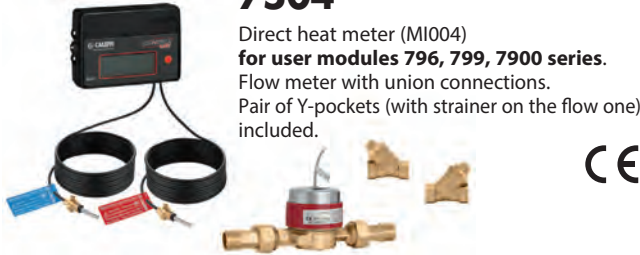

Code	Conn.	Meas. type	Q <sub>p</sub> m <sup>3</sup> /h	Q <sub>i</sub> l/h
750405	3/4"	single jet	2,5	50
750406	1"	multi jet	3,5	70
750407	1 1/4"	multi jet	6	120

**7504**

Direct heat meter (MI004) for modules 7000, 7001, 7002 series and for distribution and regulating units 765, 766, 767 series.



Code	Conn.	Type	Q <sub>p</sub> m <sup>3</sup> /h	Q <sub>i</sub> l/h	Max. recommended flow rate l/h
750405G	1"	single jet	2,5	50	1600

**7504**

Direct heat meter (MI004) for HIU SATK20, SATK22, SATK30, SATK32, SATK40, SATK50 series.



Code	Conn.	Type	Q <sub>p</sub> m <sup>3</sup> /h	Q <sub>i</sub> l/h	Max. recommended flow rate l/h
750405K	1"	single jet	2,5	50	1600

Q<sub>p</sub> = permanent flow rate    Q<sub>i</sub> = minimum flow rate

**CONTECA EASY ULTRA 7507 series**

tech. broch. 01307

Direct heat metering with local reading by means of LCD or centralised reading by means of Bus transmission.

The heat meter is supplied with:

- Pair of immersion temperature probe (L= 1,9 m).
- Ultrasonic heat meter (Tmax 90 °C).
- Electronic integrator with LCD.
- Accuracy class: 2.

- **Electric supply 24 V (AC) 50 Hz - 1 W**

**Fitted for Bus RS-485 transmission in M-Bus protocol.**

Optional MODBUS-RTU.

**7507**

Ultrasonic direct heat meter (MI004) for user modules 796, 799, 7900 series. Flow meter with union connections. Pair of Y-pockets (with strainer on the flow one) included.



Code	Conn.	Q <sub>p</sub> m <sup>3</sup> /h	Q <sub>i</sub> l/h
750705	3/4"	2,5	10
750706	1"	3,5	35
750707	1 1/4"	6	24

**7507**

Ultrasonic direct heat meter (MI004) for modules 7000, 7001, 7002 series.



Code	Conn.	Q <sub>p</sub> m <sup>3</sup> /h	Q <sub>i</sub> l/h
750705G	1"	2,5	10

**7507**

Ultrasonic direct heat meter (MI004) for HIU SATK20, SATK22, SATK30, SATK32, SATK40, SATK50 series.



Code	Conn.	Q <sub>p</sub> m <sup>3</sup> /h	Q <sub>i</sub> l/h
750705K	1"	2,5	10

Q<sub>p</sub> = permanent flow rate    Q<sub>i</sub> = minimum flow rate

**ELECTRONIC OPTIONS**

**755810**

Cooling metering option for 7504 and 7505 series. The CONTECA series meters can be activated via software to keep a record of the thermal and refrigeration unit consumption in separate registers through the evaluation of a negative temperature difference.

Code
755810

**750811**

MODBUS-RTU transmission option for 7504 and 7505 series. Transmission settings: 9600,E,8,1.

Code
750811

HYDRAULIC OPTIONS

70005

Domestic water meter kit.  
For user module 7000, 7001, 7002  
(except codes 700036 and 700136).

- Consisting of:
- ball shut-off valve with built-in check valve BALLSTOP
  - flow meter (MI001)
  - shut-off ball valve with male terminal
  - flushing pipe
  - mounting bracket.



Conforms to directive 2014/32/UE (MI001)

Code		Pulse weight (l/pulse)
700050	domestic hot water 3/4" with local reading	-
700051	domestic hot water 3/4" with pulse output	10
700052	domestic cold water 3/4" with local reading	-
700053	domestic cold water 3/4" with pulse output	10

700009

Template with 3/4" valves for domestic water meter.  
For user module 7000, 7001, 7002  
(except codes 700036 and 700136).  
Tmax. 55 °C.



Code	
700009	

7942

Water meter for domestic hot / cold water (MI001).  
With pulse output.  
1/2": for template code 794540,  
3/4": for unit codes 700037.



Conforms to directive 2014/32/UE (MI001)

Code		Pulse weight (l/pulse)
794204	1/2" - domestic cold water (Tmax. 30 °C) - L= 110 mm*	10
794205	3/4" - domestic cold water (Tmax. 30 °C) - L= 130 mm*	10
794205/C	3/4" - domestic hot water (30-90 °C) - L= 130 mm*	10

\* Length without unions

7941

Domestic water meter kit.  
For user module 796, 799, 7900 series.

- Consisting of:
- ball shut-off valve with built-in check valve BALLSTOP
  - flow meter (MI001), with pulse output
  - shut-off ball valve with male terminal.



Conforms to directive 2014/32/UE (MI001)

Code		Pulse weight (l/pulse)
794140	domestic cold water 1/2"	10
794141	domestic hot water 1/2"	10
794150	domestic cold water 3/4"	10
794151	domestic hot water 3/4"	10

7940

Domestic water meter kit.  
For user module 796, 799, 7900 series.

- Consisting of:
- ball shut-off valve with built-in check valve BALLSTOP
  - flow meter (MI001), with local reading
  - shut-off ball valve with male terminal.



Conforms to directive 2014/32/UE (MI001)

Code	
794040	domestic cold water 1/2"
794041	domestic hot water 1/2"
794050	domestic cold water 3/4"
794051	domestic hot water 3/4"

**PRE-FORMED INSULATION**



**798**

Pre-formed insulation for user module 799, 7900 series without distribution.

Code

<b>798205</b>	3/4"	- 2-way module
<b>798206</b>	1"	- 2-way module
<b>798207</b>	1 1/4"	- 2-way module



**798**

Insulation for pair of manifolds. For user module 796, 799 series. Max. 8 outlets.

Code

<b>798015</b>	3/4"
<b>798016</b>	1"
<b>798017</b>	1 1/4"



**798**

Pre-formed insulation for user module 796, 7900 series without distribution.

Code

<b>798305</b>	3/4"	- 3-way module
<b>798306</b>	1"	- 3-way module
<b>798307</b>	1 1/4"	- 3-way module

**N.B.:** Carry out the order for the insulation together with the module. It is not possible to apply it later.



# COMPONENTS FOR RENEWABLE ENERGY SYSTEMS

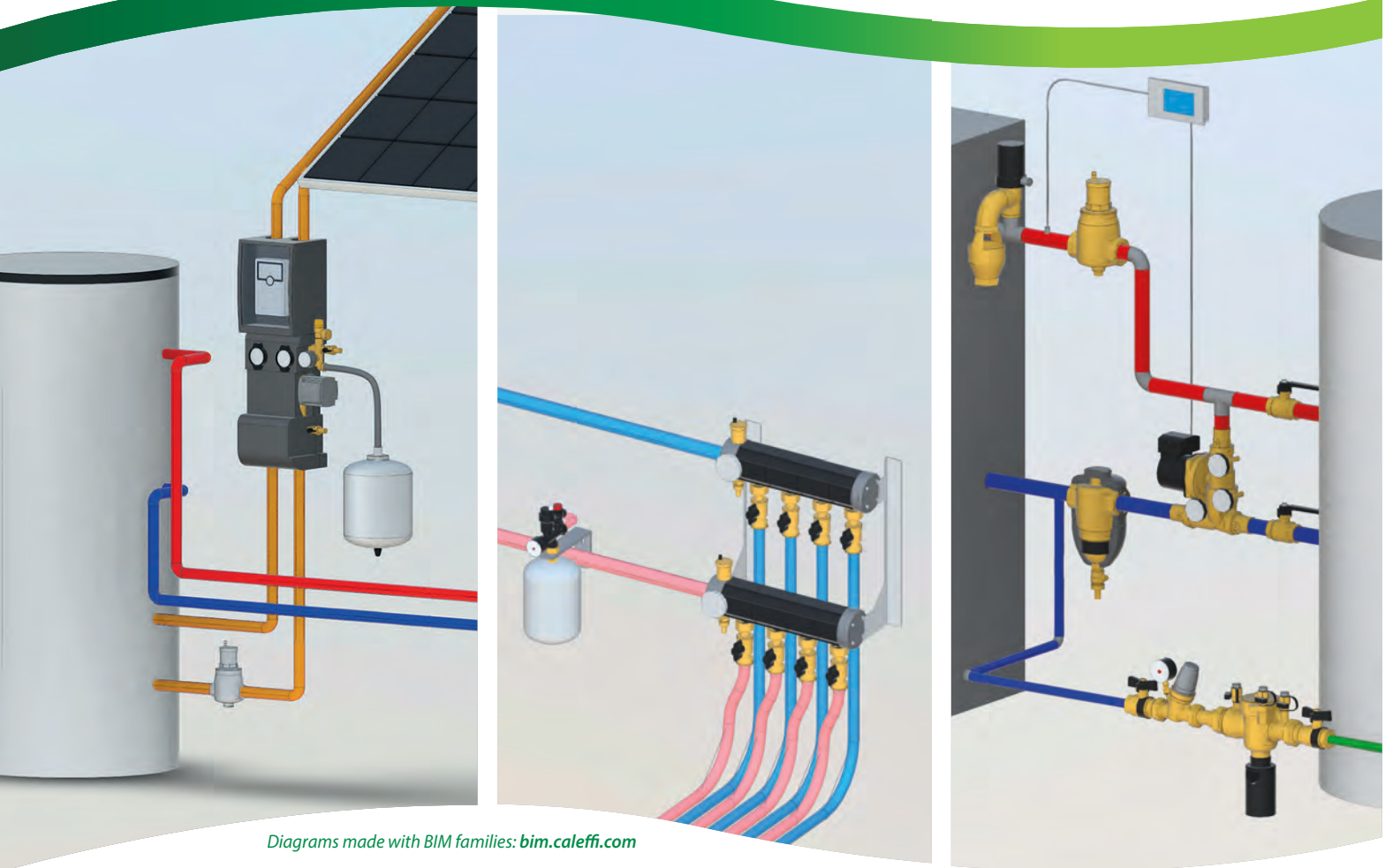

Diagrams made with BIM families: [bim.caleffi.com](http://bim.caleffi.com)

**Components for solar thermal systems**  
**Components for geothermal systems**  
**Components for biomass systems**

## COMPONENTS FOR SOLAR THERMAL SYSTEMS

The CALEFFI SOLAR product range has been specifically developed for use in solar thermal systems, where high temperatures can normally be reached and where, depending on the kind of system, there can be glycol. Materials and performance of the components must necessarily take into account these particular operating conditions.

### - Components for closed systems

---

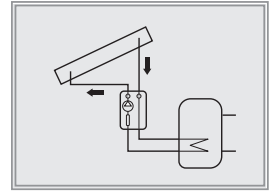

### - Components for opened systems

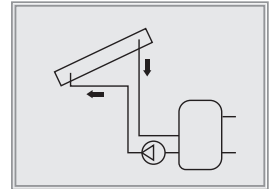

## COMPONENTS FOR GEOTHERMAL SYSTEMS

The products in the CALEFFI GEO series have been specifically designed for use in heat pump systems. In ground source heat pumps a mixture of water and antifreeze fluid is generally used to protect against freezing temperatures. The components are made with high-performance materials for this type of applications.

### - Components for water-water heat pumps

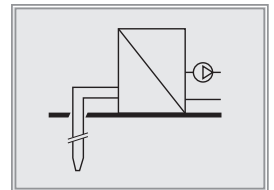

## COMPONENTS FOR BIOMASS SYSTEMS

The CALEFFI BIOMASS® product series has been created specifically to be used in circuits of systems with wood solid fuel generators, operating at high temperature with water or glycol solutions as thermal medium. The materials of the components and their performance take account of the specific system needs in terms of efficiency and safety of the generators and systems.

### - Safety and protection components

---

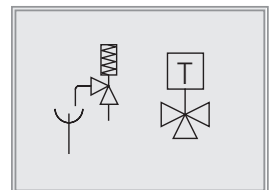

### - Control units

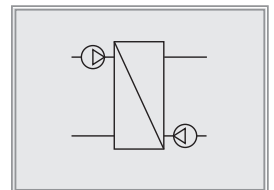

# COMPONENTS FOR SOLAR THERMAL SYSTEMS

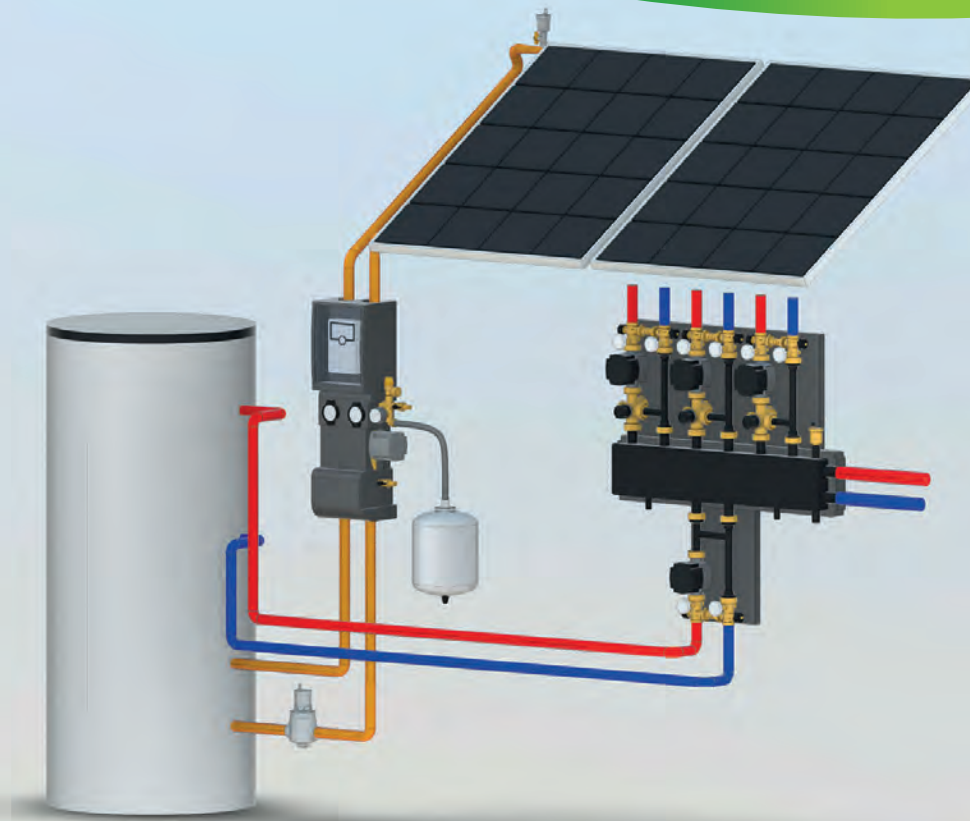

Diagrams made with BIM families: [bim.caleffi.com](http://bim.caleffi.com)

**Safety relief valve - Automatic air vents**  
**Deaerators, DISCAL® - Manual air separator**  
**Pump stations**  
**Components for pump stations**  
**Ball valve**  
**Mechanical fittings with O-Ring seal - Three piece union fitting**  
**Digital regulator**  
**Heat meter CONTECA SOLAR®**  
**Balancing valve with flow meter**  
**Temperature and pressure relief valve**  
**Antifreeze safety device**  
**Motorised ball diverter valve**  
**Thermostatic diverter valve**  
**Thermostatic mixing valves**  
**Solar storage-to-boiler connection kit**

**CALEFFI**  
**SOLAR**



**Domestic Water Sizer**   
DOMESTIC WATER SYSTEM SIZER ALSO FOR SMARTPHONE  
Available on [www.caleffi.com](http://www.caleffi.com) and app for smartphone.  
Download the version for your iOS and Android® mobile phone.

SAFETY RELIEF VALVE - AUTOMATIC AIR VENTS



253

tech. broch. 01089

Safety relief valve for solar thermal systems.  
 Brass body. Chrome plated.  
 Female connections. PN 10.  
**Temperature range: -30-160 °C.**  
**Max. percentage of glycol: 50 %.**  
 Oversized discharge outlet.  
 Discharge rating: 1/2" - 50 kW;  
 3/4" - 100 kW.  
 TÜV certified to TRD 721 - SV 100 § 7.7.  
 Settings: 2,5 - 3 - 4 - 6 - 8 - 10 bar.



Code					
253042	1/2" F x 3/4" F	2,5 bar	1	50	
253043	1/2" F x 3/4" F	3 bar	1	50	
253044	1/2" F x 3/4" F	4 bar	1	50	
253046	1/2" F x 3/4" F	6 bar	1	50	
253048	1/2" F x 3/4" F	8 bar	1	50	
253040	1/2" F x 3/4" F	10 bar	1	50	
253052	3/4" F x 1" F	2,5 bar	1	25	
253053	3/4" F x 1" F	3 bar	1	25	
253054	3/4" F x 1" F	4 bar	1	25	
253056	3/4" F x 1" F	6 bar	1	25	
253058	3/4" F x 1" F	8 bar	1	25	
253050	3/4" F x 1" F	10 bar	1	25	



250

tech. broch. 01133

Consisting of:  
 - Automatic air vent for solar thermal systems.  
 Brass body. Chrome plated.  
 Max. working pressure: 10 bar.  
 Max. discharge pressure: 5 bar.  
**Temperature range: -30-180 °C.**  
**Max. percentage of glycol: 50 %.**  
 - Shut-off cock complete with seal.  
 Brass body. Chrome plated.  
 Max. working pressure: 10 bar.  
**Temperature range: -30-200 °C.**  
**Max. percentage of glycol: 50 %.**



Code				
250031	3/8" M	without cock	1	25
250131	3/8" M		1	25
250041	1/2" M	without cock	1	25



250

Consisting of:  
 - Automatic air vent for solar thermal systems.  
 Brass body. Chrome plated.  
 Max. working pressure: 10 bar.  
 Max. discharge pressure: 2,5 bar.  
**Temperature range: -30-180 °C.**  
**Max. percentage of glycol: 50 %.**  
 - Shut-off cock complete with seal.  
 Brass body. Chrome plated.  
 Max. working pressure: 10 bar.  
**Temperature range: -30-200 °C.**  
**Max. percentage of glycol: 50 %.**



Code				
250831	3/8" M	without cock	1	50
250931	3/8" M		1	50



251

DISCALAIR®

tech. broch. 01135

High-performance automatic air vent for solar thermal systems.  
 Brass body. Chrome plated.  
 Female connections.  
 Max. working pressure: 10 bar.  
 Max. discharge pressure: 10 bar.  
**Temperature range: -30-160 °C.**  
**Max. percentage of glycol: 50 %.**



Code				
251004	1/2" F		1	10



250

tech. broch. 01133

Shut-off cock complete with seal.  
 Brass body. Chrome plated.  
 Max. working pressure: 10 bar.  
**Temperature range: -30-200 °C.**  
**Max. percentage of glycol: 50 %.**



Code				
250300	3/8" M x 3/8" F	- butterfly handle	1	10
250400	1/2" M x 1/2" F	- lever handle	1	10

The automatic air vent must be shut off after the system has been filled.





DEAERATORS



**251 DISCAL®**

tech. broch. 01134

Deaerator for solar thermal systems.  
Brass body.  
Female connections.  
Max. working pressure: 10 bar.  
Max. discharge pressure: 10 bar.  
**Temperature range: -30-160 °C.**  
**Max. percentage of glycol: 50 %.**

Code

251003 3/4" F



1 10

MANUAL AIR SEPARATOR



**251**

tech. broch. 01197

Manual air separator for solar thermal systems.  
Brass body.  
Female connections.  
Max. working pressure: 10 bar.  
**Temperature range: -30-200 °C.**  
**Max. percentage of glycol: 50 %.**

Code

251093 3/4" F



1 10



**251 DISCAL®**

tech. broch. 01134

Deaerator for solar thermal systems.  
Brass body.  
Female connections.  
With drain.  
Max. working pressure: 10 bar.  
Max. discharge pressure: 10 bar.  
**Temperature range: -30-160 °C.**  
**Max. percentage of glycol: 50 %.**

Code

251006 1" F



1 -

251007 1 1/4" F

1 -

Application diagram of DISCAL® 251 series for vertical pipes

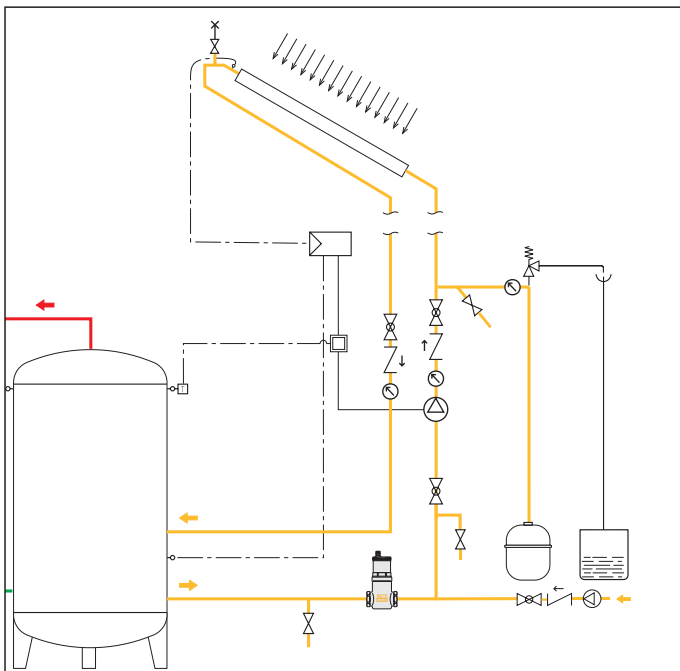

Application diagram 251 series

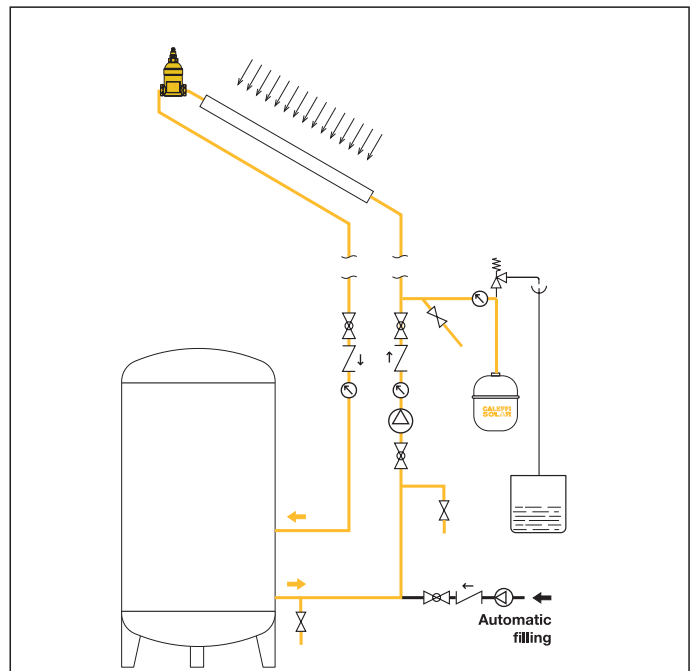

PUMP STATIONS

278

Pump station for solar thermal systems, return connection.  
 Electric supply: 230 V (AC).  
 Max. working pressure: 10 bar.  
**Safety relief valve temperature range: -30-160 °C.**  
 Safety relief valve setting: 6 bar (for other setting, see 253 series using the adapter code F21224).  
**Flow meter temperature range: -10-110 °C.**  
**Max. percentage of glycol: 50 %.**

- Consisting of:
- Solar circulation pump;
  - safety relief valve for solar thermal systems 253 series;
  - fill/drain cock;
  - instrument holder fitting with pressure gauge;
  - flow meter;
  - return temperature gauge;
  - shut-off valve with check valve;
  - 2 hose connections;
  - pre-formed shell **insulation**.



Code	Flow meter scale (l/min)	Pump		
278050HE	3/4" F 1-13	UPM3 15-75*	1	-
278052HE	3/4" F 8-30	UPM3 15-75*	1	-

\* With on/off and PWM control

279

Pump station for solar thermal systems, flow and return connection.  
 Electric supply: 230 V (AC).  
 Max. working pressure: 10 bar.  
**Safety relief valve temperature range: -30-160 °C.**  
 Safety relief valve setting: 6 bar (for other setting, see 253 series using the adapter code F21224).  
**Flow meter temperature range: -10-110 °C.**  
**Max. percentage of glycol: 50 %.**

- Consisting of:
- Solar circulation pump;
  - safety relief valve for solar thermal systems 253 series;
  - 2 fill/drain cocks;
  - instrument holder fitting with pressure gauge;
  - flow meter;
  - deaerator device;
  - flow temperature gauge;
  - return temperature gauge;
  - 2 shut-off valves with check valves;
  - 2 hose connections;
  - pre-formed shell **insulation**.

Fitted for coupling with digital regulator DeltaSol® SLL



Code	Flow meter scale (l/min)	Pump		
279050HE	3/4" F 1-13	UPM3 15-75*	1	-
279052HE	3/4" F 8-30	UPM3 15-75*	1	-

\* With on/off and PWM control

PUMP STATIONS

255

Pump station for solar thermal systems, flow and return connection.  
 Electric supply: 230 V (AC).  
 Max. working pressure: 10 bar.  
**Safety relief valve temperature range: -30-160 °C.**  
 Safety relief valve setting: 6 bar (for other setting see 253 series).  
**Max. flow meter temperature: 120 °C.**  
**Max. percentage of glycol: 50 %.**

- Consisting of:
- Solar circulation pump;
  - safety relief valve for solar thermal systems 253 series;
  - 2 fill/drain cocks with hose connections;
  - instrument holder fitting with pressure gauge;
  - flow regulator with flow meter;
  - deaerator device;
  - flow temperature gauge;
  - return temperature gauge;
  - 2 shut-off valves with check valves;
  - pre-formed shell **insulation**.



Code	Flow meter scale (l/min)	Pump		
255266HE	1" F 5-40	PML 25-145*	1	-

\* With PWM control only

DIGITAL REGULATOR

278

Digital regulator DeltaSol® SLL with PWM control.  
 Electric supply: 230 V (AC).  
 Complete with pre-formed shell **insulation** for coupling with pump stations 278...HE, 279...HE and 255...HE series.  
 Complete with 3 Pt1000 probes, with fourth probe as optional.  
**Functions:** differential temperature regulator with supplementary and optional functions.  
**Inputs** for 4 Pt1000 probes.  
**Outputs:** 3 semiconductor relays  
 2 PWM.



Code			
278005		1	-
F29883	PWM cable	1	-

ACCESSORIES FOR PUMP STATIONS



259

tech. broch. 01246

Welded expansion vessel only for primary circuit of solar thermal systems, EC certification. Bladder membrane. Max. working pressure: 10 bar. System working temperature range: -10–120 °C. Membrane working temperature range: -10–70 °C. Max. percentage of glycol: 50 %. Conformity to EN 13831 standard.



Code	Litres	Conn.	Precharge (bar)		
259008	8	3/4"	2,5	1	–
259012	12	3/4"	2,5	1	–
259018	18	3/4"	2,5	1	–
259025	25	3/4"	2,5	1	–
259033	33	3/4"	2,5	1	–



259

tech. broch. 01246

Welded expansion vessel only for primary circuit of solar thermal systems, EC certification. Diaphragm membrane. Max. working pressure: 10 bar. System working temperature range: -10–120 °C. Membrane working temperature range: -10–70 °C. Max. percentage of glycol: 50 %. Conformity to EN 13831 standard.



Code	Litres	Conn.	Precharge (bar)		
259050	50	3/4"	2,5	1	–
259080	80	1"	2,5	1	–



255

tech. broch. 01136

Expansion vessel connection kit. Consisting of:  
 - stainless steel flexible hose (L=610 mm);  
 - automatic shut-off cock;  
 - wall mounting bracket (for vessels up to 24 litres).  
 Max. working pressure: 10 bar.  
**Shut-off cock max. working temperature: 110 °C.**  
**Max. percentage of glycol: 50 %.**

Code	Conn.		
255007	3/4"	1	–



5580

Ball shut-off valve, for expansion vessels, with drain cock. **For solar thermal systems.** Max. working pressure: 6 bar. **Max. working temperature: 120 °C.** **Max. percentage of glycol: 50 %.**

Code	Conn.		
558052	3/4"	1	20
558062	1"	1	20



255

System filling pump for pump stations 279, 278 and 255 series.

Code		
255010	1	–



Adapter for pump stations 278 and 279 series. To be used for the installation of the 1/2" safety relief valve 253 series.

Code
F21224

BALL VALVE



240

tech. broch. 01185

Ball valve for solar thermal systems. **Body and ball in stainless steel AISI 316.** PN 63. Female connections. Handle in stainless steel AISI 304. **Temperature range: -30–200 °C.** **Max. percentage of glycol: 50 %.**

Code	Conn.		
240400	1/2"	1	5
240500	3/4"	1	5
240600	1"	1	5

**SPARE PARTS FOR CIRCULATION UNITS FOR 278/279 SERIES**



Pump UPM3 15-75 for 278HE and 279HE series, with cable



Code

**F29885** UPM3 15-75 pump



Spare flow meters for 278 and 279 series circulation units.

Code	Flow meter scale (l/min)
<b>278003</b>	1-13
<b>278004</b>	8-30



Safety relief valve 6 bar

Code

**F000602**

Code

**161006** Pt1000 probe - temperature: -5-80 °C

**257006** Pt1000 probe - temperature: -50-180 °C

**161014** pocket for Pt1000 probe

**257007** flow temperature gauge for 267, 269 and 279 series

**257008** return temperature gauge for 266, 267, 268, 269, 278 and 279 series

**R29435** pressure gauge for 278, 279 series

**SPARE PARTS FOR CIRCULATION UNITS FOR 255/256 SERIES**



Flow meter 1" 5-40 for unit code 255266HE

Code

**255003** flow temperature gauge 0-160 °C

**255004** return temperature gauge 0-160 °C

**255005** pressure gauge Ø 40, 0-6 bar

Code

**255018**



Pump PML Solar 25-145 for unit 255266



Code

**F000565\*** PML 25-145 pump

\* With PWM control only

MECHANICAL FITTINGS WITH O-RING SEAL



2540

Female fitting, mechanical O-Ring seal for solar thermal systems. For annealed copper, hard copper, brass, mild and stainless steel pipes. Max. working pressure: 16 bar. **Temperature range: -30-160 °C.** **Max. percentage of glycol: 50 %.** Black nickel plated nut.

Code			
254055	3/4" F - Ø 15	1	25
254058	3/4" F - Ø 18	1	25
254052	3/4" F - Ø 22	1	25
254062	1" F - Ø 22	1	25
254068	1" F - Ø 28	1	10



2546

Tee fitting, mechanical O-Ring seal for solar thermal systems. For annealed copper, hard copper, brass, mild and stainless steel pipes. Max. working pressure: 16 bar. **Temperature range: -30-160 °C.** **Max. percentage of glycol: 50 %.** Black nickel plated nut.

Code			
254602	Ø 22	1	20



2543

Coupling sleeve, mechanical O-Ring seal for solar thermal systems. For annealed copper, hard copper, brass, mild and stainless steel pipes.

Max. working pressure: 16 bar. **Temperature range: -30-160 °C.** **Max. percentage of glycol: 50 %.** Black nickel plated nut.

Code			
254305	Ø 15	1	25
254308	Ø 18	1	25
254302	Ø 22	1	25



2544

Male fitting, mechanical O-Ring seal for solar thermal systems. For annealed copper, hard copper, brass, mild and stainless steel pipes. Max. working pressure: 16 bar. **Temperature range: -30-160 °C.** **Max. percentage of glycol: 50 %.** Black nickel plated nut.

Code			
254455	3/4" M - Ø 15	1	25
254458	3/4" M - Ø 18	1	25
254452	3/4" M - Ø 22	1	25
254465	1" M - Ø 15	1	25
254462	1" M - Ø 22	1	25



2545

Elbow coupling sleeve, mechanical O-Ring seal for solar thermal systems. For annealed copper, hard copper, brass, mild and stainless steel pipes. Max. working pressure: 16 bar. **Temperature range: -30-160 °C.** **Max. percentage of glycol: 50 %.** Black nickel plated nut.

Code			
254505	Ø 15	1	25
254508	Ø 18	1	25
254502	Ø 22	1	25



2547

Male elbow fitting, mechanical O-Ring seal for solar thermal systems. For annealed copper, hard copper, brass, mild and stainless steel pipes. Max. working pressure: 16 bar.

**Temperature range: -30-160 °C.** **Max. percentage of glycol: 50 %.** Black nickel plated nut.

Code			
254755	3/4" M - Ø 15	1	25
254758	3/4" M - Ø 18	1	25
254752	3/4" M - Ø 22	1	25



2548

Female elbow fitting, mechanical O-Ring seal for solar thermal systems. For annealed copper, hard copper, brass, mild and stainless steel pipes. Max. working pressure: 16 bar.

**Temperature range: -30-160 °C.** **Max. percentage of glycol: 50 %.** Black nickel plated nut.

Code			
254855	3/4" F - Ø 15	1	25
254858	3/4" F - Ø 18	1	25
254852	3/4" F - Ø 22	1	25



2540

Plug for Ø 22 copper pipe.

Code			
254002	Ø 22	1	25

THREE-PIECE UNION FITTING



588

Three-piece straight union fitting for solar thermal systems. Max. working pressure: 16 bar. **Temperature range: -30-160 °C.** **Max. percentage of glycol: 50 %.** Black nickel plated nut.

Code			
588052	3/4" F x M with union	1	25
588062	1" F x M with union	1	20

HEAT METER

**75025 CONTECA EASY SOLAR** tech. broch. 01311

Direct heat metering **with local reading via LCD display/centralised reading via BUS transmission.**

Max. working pressure: 10 bar.  
Temperature range: 5–120 °C.  
Max. percentage of glycol: 50 %.

The CONTECA EASY SOLAR heat meter is supplied complete with:

- a pair of temperature probes,
- a pair of Y pockets for immersion probes,
- flow meter with pulse output (Tmax 120 °C),
- electronic calculator with LCD display.

**Electric supply 24 V (AC) (+10 % - 5 %) / 50/60 Hz - 1 W.**  
**Fitted for transmission on Bus RS-485.**



Code	Conn.	Meas. type	Q <sub>nom</sub> m <sup>3</sup> /h		
750254	1/2"	single jet	1,5	1	-
750255	3/4"	single jet	2,5	1	-
750256	1"	multi jet	3,5	1	-
750257	1 1/4"	multi jet	6	1	-
750258	1 1/2"	multi jet	10	1	-
750259	2"	multi jet	15	1	-

BALANCING VALVE WITH FLOW METER

**258** tech. broch. 01148

Balancing valve with flow meter, for solar thermal systems.

Direct reading of flow rate.  
Brass valve body and flow meter.  
Ball valve for flow rate adjustment.  
Graduated scale flow meter with magnetic movement flow rate indicator.

**With insulation.**

Max. working pressure: 10 bar.  
**Temperature range: -30–130 °C.**  
**Max. percentage of glycol: 50 %.**  
PATENT.



Code	Flow rate range (l/min)			
258503	3/4"	2– 7	1	5
258533	3/4"	3–10	1	5
258523	3/4"	7–28	1	5
258603	1"	10–40	1	5

Application diagram of heat meter 75025 series and balancing valve 258 series

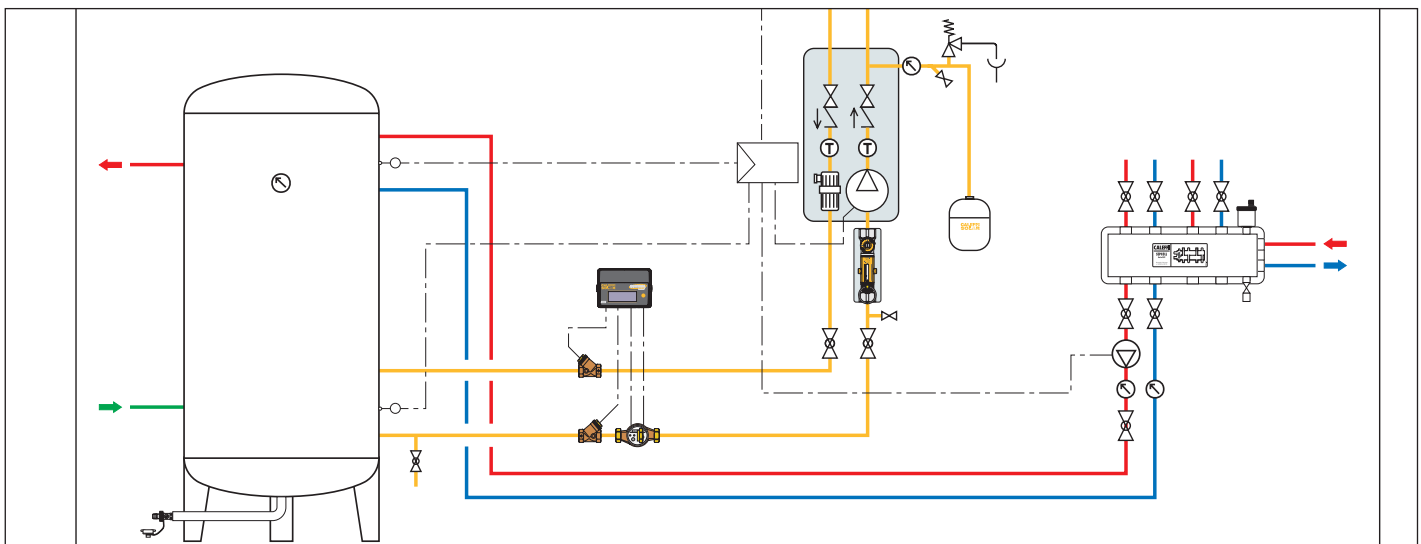

## TEMPERATURE AND PRESSURE RELIEF VALVE



### 309

tech. broch. 01147

Temperature and pressure relief valve.  
**For solar thermal systems, to protect the hot water storage.**  
 CR dezincification resistant alloy body.  
 Chrome plated.  
 Setting temperature: 90 °C.  
 Discharge rating:  
 1/2" x Ø 15: 10 kW.  
 3/4" x Ø 22: 25 kW.  
 Settings: 6 - 7 - 10 bar.  
**Settings certified to EN 1490: 7 - 10 bar.**



Code



309461	1/2" M x Ø 15	6 bar	1	20
309471	1/2" M x Ø 15	7 bar	1	20
309401	1/2" M x Ø 15	10 bar	1	20
309561	3/4" M x Ø 22	6 bar	1	20
309571	3/4" M x Ø 22	7 bar	1	20
309501	3/4" M x Ø 22	10 bar	1	20

### Function

The temperature and pressure relief valve controls and limits the temperature and pressure of the hot water contained in a solar domestic water storage heater and prevents it to reach temperatures over 100°C, with the formation of steam. On reaching the settings, the valve discharges a sufficient amount of water into the atmosphere so that the temperature and pressure return within the system's operating limits. As the temperature and pressure decrease, the opposite action occurs with the valve subsequently reclosing within the set tolerances.

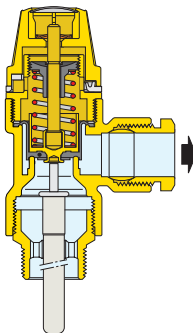

### Product certification in accordance with European Standard EN 1490

European Standard EN 1490: 2000, entitled "Building valves - Combined temperature and pressure relief valves - Tests and requirements", describes the constructional and performance specifications that TP relief valves must have. Caleffi 309 series TP relief valves for solar systems are certified by Buildcert (UK) to comply with the requirements of the European Standard EN 1490.

### Application diagram of valve 309 series on a solar hot water storage

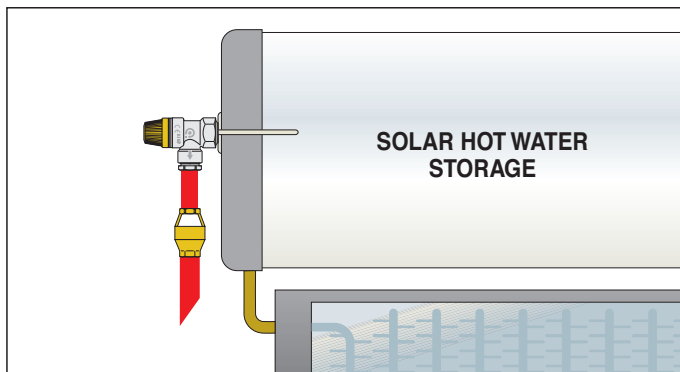

## ANTIFREEZE SAFETY DEVICE



### 603

ICECAL®

Antifreeze safety device.  
**For solar thermal systems, to protect the hot water storage.**  
 CR dezincification resistant alloy body.  
 Max. working pressure: 10 bar.  
 Ambient temperature range: -30-90 °C.  
 Opening temperature: 3 °C.  
 Closing temperature: 4 °C.

Code



603040	1/2" F with nut	1	50
--------	-----------------	---	----

### Function

The antifreeze safety device prevents ice build-up in domestic water circuits, thereby avoiding potential damage to storage tanks and pipes

When the minimum ambient intervention temperature is reached, it automatically opens a minimum passage of water toward the drain, enabling a small continuous flow of water at the inlet; this prevents any risk of freezing.

When the ambient temperature increases or in the event of contact with warmer water, the opposite action occurs, causing the device to shut off and circuit normal operating conditions to be restored.

### Closed position

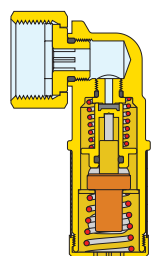

### Open position

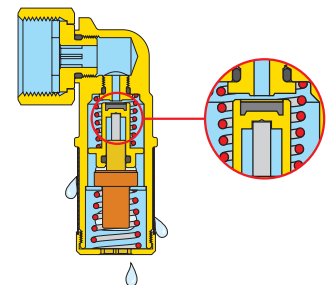

### Application diagram of device 603 series on a domestic water circuit

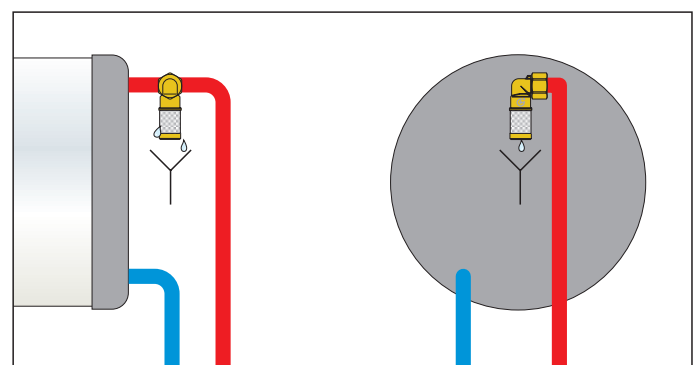



MOTORISED BALL DIVERTER VALVE



6443

tech. broch. 01132

Motorised three-way ball diverter valve.  
Max. working pressure: 10 bar.  
Max. Δp: 10 bar.  
Temperature range: -5–110 °C.

**Complete with actuator with 3-contact control.**  
**With auxiliary microswitch.**  
Supply: 230 V (AC) or 24 V (AC).  
Auxiliary microswitch contact rating: 0,8 A (230 V).  
Ambient temperature range: 0–55 °C.  
Protection class: IP 54.  
**Operating time: 10 s (90° rotation).**  
Cable length: 100 cm.

Code		Supply voltage V	Kv (m <sup>3</sup> /h)	Power consumption (VA)		
644346	1/2"	230	3,9	4	1	5
644356	3/4"	230	3,9	4	1	5
644357	3/4"	230	8,6	4	1	5
644366	1"	230	9	4	1	5
644348	1/2"	24	3,9	8	1	5
644358	3/4"	24	3,9	8	1	5
644359	3/4"	24	8,6	8	1	5
644368	1"	24	9	8	1	5



THERMOSTATIC DIVERTER VALVES



2620

tech. broch. 01335

Thermostatic diverter valve for solar thermal systems.  
**CR** dezincification resistant alloy body.  
Max. working pressure: 10 bar.  
Factory setting: 45 °C.  
**Max. inlet temperature: 100 °C.**



Code		Temperature adjustment	Kv (m <sup>3</sup> /h)		
262040	1/2"	35–55 °C	1,5	1	10
262050	3/4"	35–55 °C	1,7	1	10



2620

tech. broch. 01335

Thermostatic diverter valve for solar thermal systems.  
**CR** dezincification resistant alloy body.  
Chrome plated.  
Max. working pressure: 10 bar.  
Factory setting: 45 °C.  
**Max. inlet temperature: 100 °C.**



Code		Temperature adjustment	Kv (m <sup>3</sup> /h)		
262060	1"	38–52 °C	2,6	1	10

Application diagram of thermostatic diverter valve 2620 series

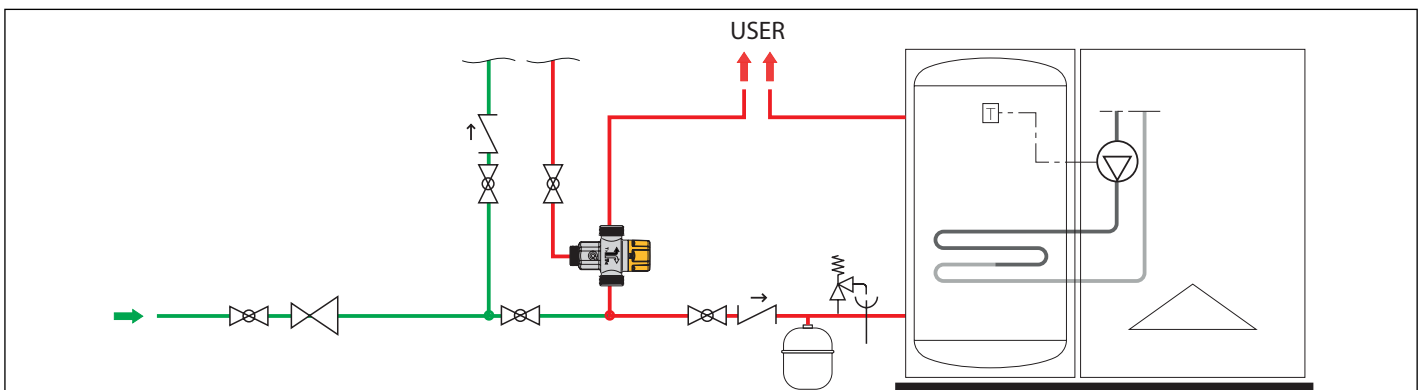
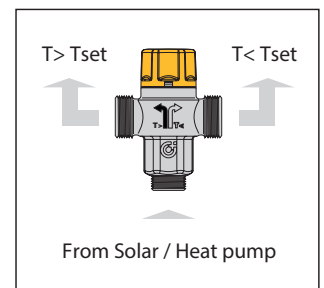
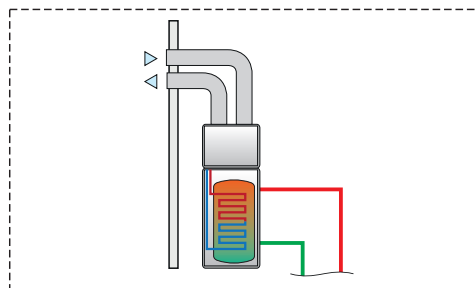
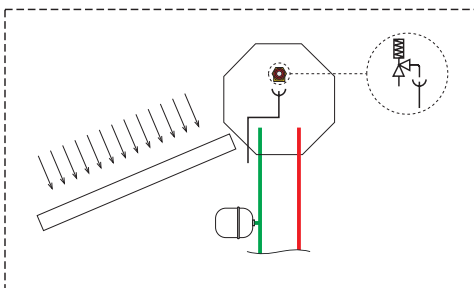

THERMOSTATIC MIXING VALVES



2521



tech. broch. 01127

Adjustable thermostatic mixing valve for solar thermal systems.  
 CR dezincification resistant alloy body  
 "LOW LEAD". Chrome plated.  
 Male union connections.  
 Max. working pressure: 14 bar.  
**Max. inlet temperature: 100 °C.**



Code	Temperature adjustment	Kv (m³/h)		
252140	1/2"	30-65 °C	2,6	1 10
252150	3/4"	30-65 °C	2,6	1 10

2521



tech. broch. 01257

Thermostatic mixing valve for centralised solar thermal systems.  
 CR dezincification resistant alloy body.  
 Male union connections.  
 Antiscale inner regulator in technopolymer.  
 Max. working pressure: 14 bar.  
**Max. inlet temperature: 100 °C.**



Code	Temperature adjustment	Kv (m³/h)		
252151	3/4"	35-65 °C	4,5	1 10
252160	1"	35-65 °C	5,5	1 -
252170	1 1/4"	35-65 °C	7,6	1 -
252180	1 1/2"	35-65 °C	11,0	1 -
252190	2"	35-65 °C	13,3	1 -



2521



tech. broch. 01127

Adjustable thermostatic mixing valve, **with check valves**, for solar thermal systems.  
 CR dezincification resistant alloy body  
 "LOW LEAD". Chrome plated.  
 Male union connections.  
 Max. working pressure: 14 bar.  
**Max. inlet temperature: 100 °C.**



Code	Temperature adjustment	Kv (m³/h)		
252153	3/4"	30-65 °C	2,6	1 10

2523



tech. broch. 01129

Thermostatic mixing valve with interchangeable cartridge for solar thermal systems.  
 Brass body.  
 Male union connections.  
 Max. working pressure: 14 bar.  
**Max. inlet temperature: 110 °C.**



Code	Temperature adjustment	Kv (m³/h)		
252340	1/2"	30-65 °C	4,0	1 -
252350	3/4"	30-65 °C	4,5	1 -
252360	1"	30-65 °C	6,9	1 -
252370	1 1/4"	30-65 °C	9,1	1 -
252380	1 1/2"	35-65 °C	14,5	1 -
252390	2"	35-65 °C	19,0	1 -

Application diagram of thermostatic mixing valve 2521 series

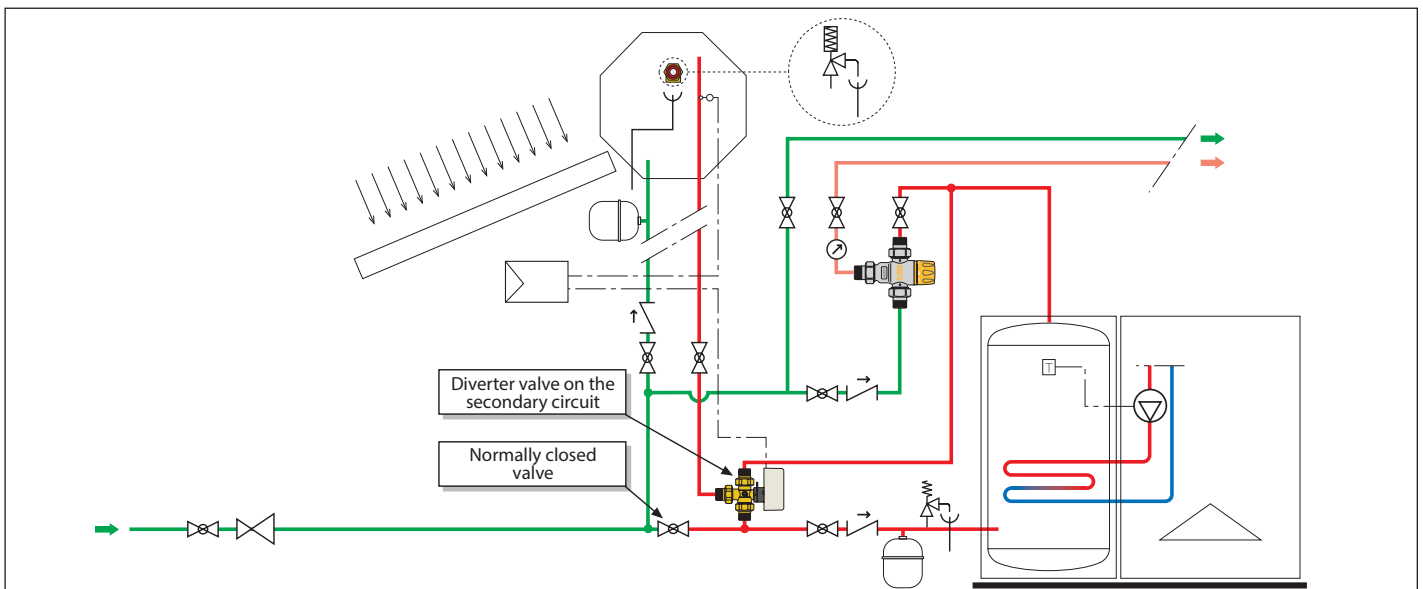

ANTI-SCALD TEMPERING AND THERMOSTATIC MIXING VALVES

2527



Adjustable anti-scald thermostatic mixing valve, **with check valves and strainers**, for solar thermal systems. High thermal performance device **with anti-scald safety function**. Brass body.



Male union connections. Performance to standards NF 079 doc. 8, EN 15092, EN 1111, EN 1287. Max. working pressure: 10 bar. **Max. inlet temperature: 100 °C.**



Code	Temperature adjustment	Kv (m <sup>3</sup> /h)		
252714	1/2"	35-55 °C	1,5	1 10
252713	3/4"	35-55 °C	1,7	1 10

2522



Adjustable thermostatic mixing valve **with check valves and strainers**, for solar thermal systems. Enhanced thermal performance device **with anti-scald safety function**. **With override function for thermal disinfection**. CR dezincification resistant alloy body.



Male union connections. Max. working pressure: 1400 kPa. **Max. inlet temperature: 100 °C. Certified to AS 4032.1.**



Code	Temperature adjustment	Kv (m <sup>3</sup> /h)		
252212TMF AUS*	DN 15	30-50 °C	1,3	1 10
252219TMF AUS	DN 20	30-50 °C	1,4	1 6

\* Without union

2522



High performance adjustable anti-scald tempering valve **with check valves and strainers** at the inlets. Suitable for solar and instantaneous hot water systems.



CR dezincification resistant alloy body. Male union connections. Max. working pressure: 1400 kPa. **Max. inlet temperature: 100 °C. Certified to AS 4032.2.**



Code	Temperature adjustment	Kv (m <sup>3</sup> /h)		
252212HP AUS	DN 15	35-55 °C	1,5	1 10
252219HP AUS	DN 20	35-55 °C	1,7	1 5

2522



Adjustable thermostatic mixing valve **with check valves and strainers**, for solar thermal systems. Enhanced thermal performance device **with anti-scald safety function**. CR dezincification resistant alloy body.



Male union connections. Max. working pressure: 1400 kPa. **Max. inlet temperature: 100 °C. Certified to AS 4032.1.**



Code	Temperature adjustment	Kv (m <sup>3</sup> /h)		
252225TM AUS	DN 25	30-50 °C	3,0	1 5

SOLAR STORAGE-TO-BOILER CONNECTION KIT

264 SOLARNOCAL

tech. broch. 01163



Function

A thermostatic anti-scald mixing valve, at the kit inlet, controls the temperature of the water coming from the solar hot water storage. The thermostat, by means of the probe positioned on the hot water flow from the solar hot water storage, controls the diverter valve at the kit outlet. Depending on the temperature setting, the valve diverts the water towards the user circuit or activates the boiler circuit, **without thermal integration**.

Hydraulic diagrams

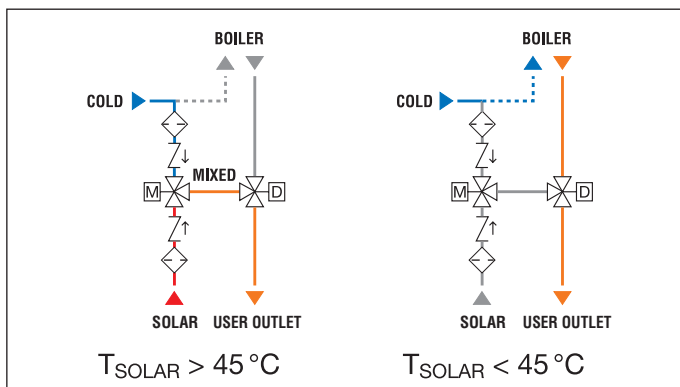

Solar storage-to-boiler connection kit, **without thermal integration**. Consisting of:

- thermostatic anti-scald mixing valve, adjustable with knob, for solar thermal systems. Complete with strainers and check valves at the inlets;
- diverter valve with three-contact actuator, with auxiliary microswitch;
- thermostat with probe for solar thermal system, for operating diverter valve. Display showing temperature.
- pre-formed **shell protective cover**.

**Diverter-to-mixing valve coupling with adjustable position** of the inlet and outlet connections.

**Mixing valve**  
 CR dezincification resistant alloy body.  
 Max. working pressure: 10 bar.  
 Adjustment temperature range: 35–55 °C.  
**Max. inlet temperature: 100 °C.**

**Diverter valve**  
 Brass body.  
 Max. working pressure: 10 bar.  
 Temperature range: -5–110 °C.

**Actuator**  
 Three-contact type.  
 Supply: 230 V (AC).  
 Power consumption: 4 VA.  
 Auxiliary microswitch contact rating: 0,8 A (230 V).  
 Ambient temperature range: 0–55 °C.  
 Protection class: IP 54.  
 Operating time: 10 s.  
 Cable length: 1 m.

**Thermostat with probe**  
 Supply: 230 V (AC).  
 Adjustable temperature range: 25–50 °C.  
 Factory setting: 45 °C.  
 Box protection class: IP 42.

Code			
<b>264352</b>	3/4"	1	-

Spare parts for connection kit 264 and 265 series.

Code	
<b>265002</b>	actuator
<b>F29488</b>	Ø 6 mm probe
<b>161014</b>	stainless steel pocket for Pt1000 probe

Application diagram of SOLARNOCAL kit 264 series

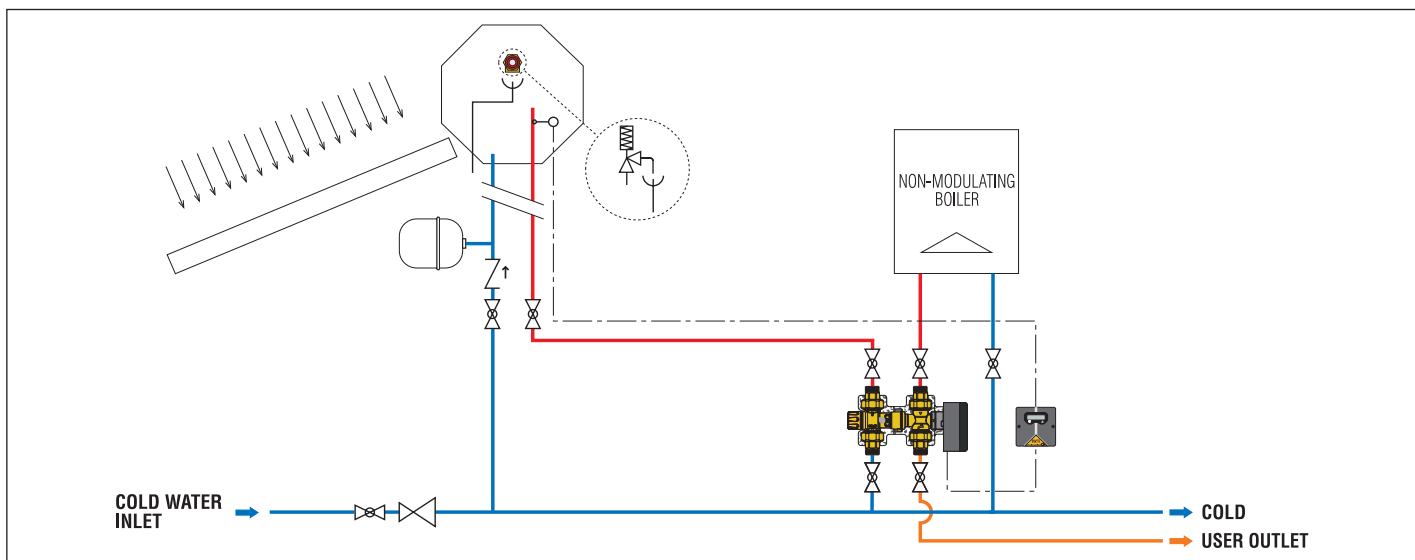

SOLAR STORAGE-TO-BOILER CONNECTION KIT

265 SOLARINCAL

tech. broch. 01163



Function

The thermostat, by means of the probe positioned on the hot water flow from the solar hot water storage, controls the diverter valve at the kit inlet. Depending on the temperature setting, the valve diverts the water towards the user circuit or the boiler circuit, **with thermal integration**. A thermostatic anti-scald mixing valve, at the kit outlet, constantly controls the temperature of the water sent to the user.

Solar storage-to-boiler connection kit, **with thermal integration**. Consisting of:

- thermostatic anti-scald mixing valve, adjustable with knob, for solar thermal systems. Complete with strainers and check valves at the inlets;
- diverter valve with three-contact actuator, with auxiliary microswitch;
- thermostat with probe for solar thermal system, for operating diverter valve. Display showing temperature.
- pre-formed **shell protective cover**.

**Diverter-to-mixing valve coupling with adjustable position** of the inlet and outlet connections.

**Mixing valve**  
For technical details see 264 series.

**Diverter valve**  
For technical details see 264 series.

**Actuator**  
For technical details see 264 series.

**Thermostat with probe**  
For technical details see 264 series.

Code			
265352	3/4"	1	-
F29384	mixing valve spare for 262 and 265 series	1	-

Hydraulic diagrams

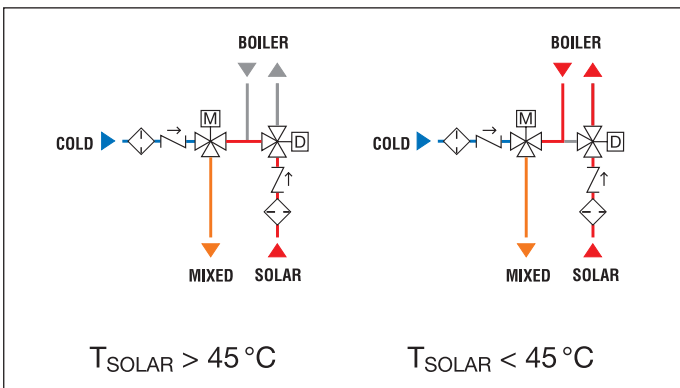

Application diagram of SOLARINCAL kit 265 series

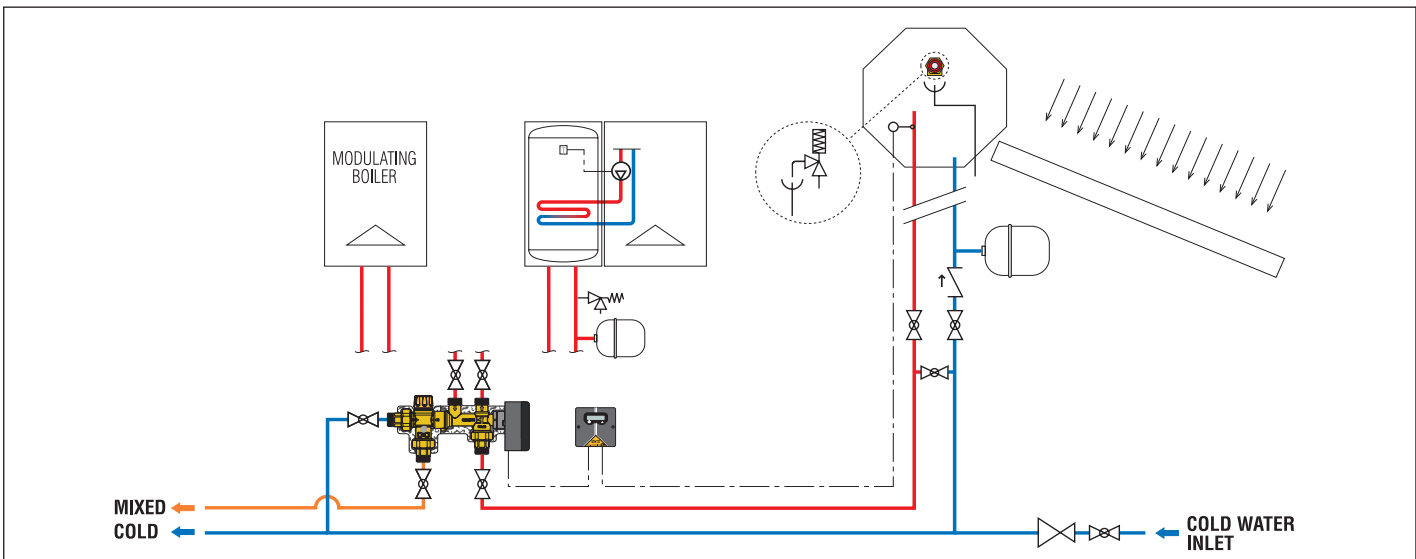

265



Thermostat with display showing storage temperature. For devices 264 and 265 series. Supply: 230 V (AC). Adjustable temperature range: 25–50 °C. Factory setting: 45 °C. Box protection class: IP 42.

Code			
265001		1	-

Accessories for connection kit 264 and 265 series.

264359	kit 264 series without thermostat and probe
265359	kit 265 series without thermostat and probe
F29525	box with switching 3 contact relay
F29466	Ø 15 mm contact probe
F29467	pocket for Ø 15 mm probe

SOLAR STORAGE-TO-BOILER THERMOSTATIC CONNECTION KIT

262 SOLARINCAL-T

tech. broch. 01164



Function

A thermostatic diverter valve, at the kit inlet, receives hot water coming from the solar water storage. Depending on the temperature setting, the valve diverts the water automatically and in a proportional manner towards the user circuit or the boiler with storage circuit, with thermal integration. The valve modulates the flow rates to optimise the energy contained in the solar storage and reduces boiler operation times to a minimum. A thermostatic anti-scald mixing valve, at the kit outlet, constantly controls and limits the temperature of the water sent to the user.

Hydraulic diagrams

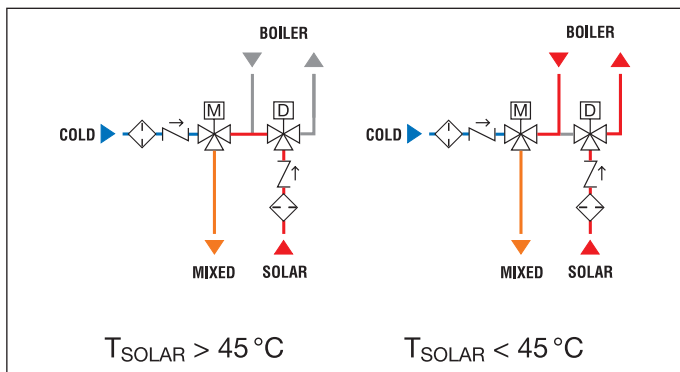

Solar storage-to-boiler connection kit, with thermal integration.

- Consisting of:
  - thermostatic anti-scald mixing valve, adjustable with knob, for solar thermal systems. Complete with strainers and check valves at the inlets.
  - thermostatic diverter valve;
  - pre-formed shell protective cover.

**Diverter-to-mixing valve coupling with adjustable position** of the inlet and outlet connections.

Mixing valve

CR dezincification resistant alloy body.  
 Max. working pressure: 10 bar.  
 Adjustment temperature range: 35–55 °C.  
**Max. inlet temperature: 100 °C.**

Performance to standards NF 079 doc. 8, EN 15092, EN 1111, EN 1287.

Diverter valve

Brass body.  
 Max. working pressure: 10 bar.  
 Factory setting: 45 °C.  
**Max. inlet temperature: 100 °C.**

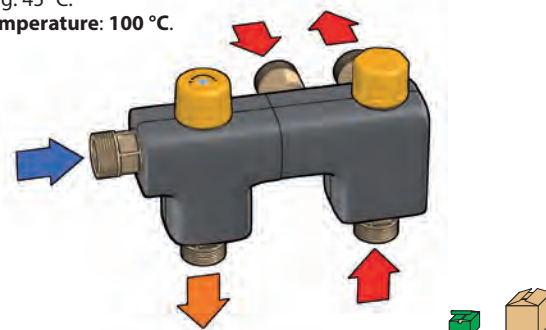

Code			
262350	3/4"	1	-
F29384	mixing valve spare for 262 and 265 series	1	-



262 SOLARINCAL-T

tech. broch. 01164

Solar storage-to-boiler connection kit, with thermal integration. Without shell protective cover.

Code			
262342	1/2"	1	-

Application diagram of SOLARINCAL-T kit 262 series

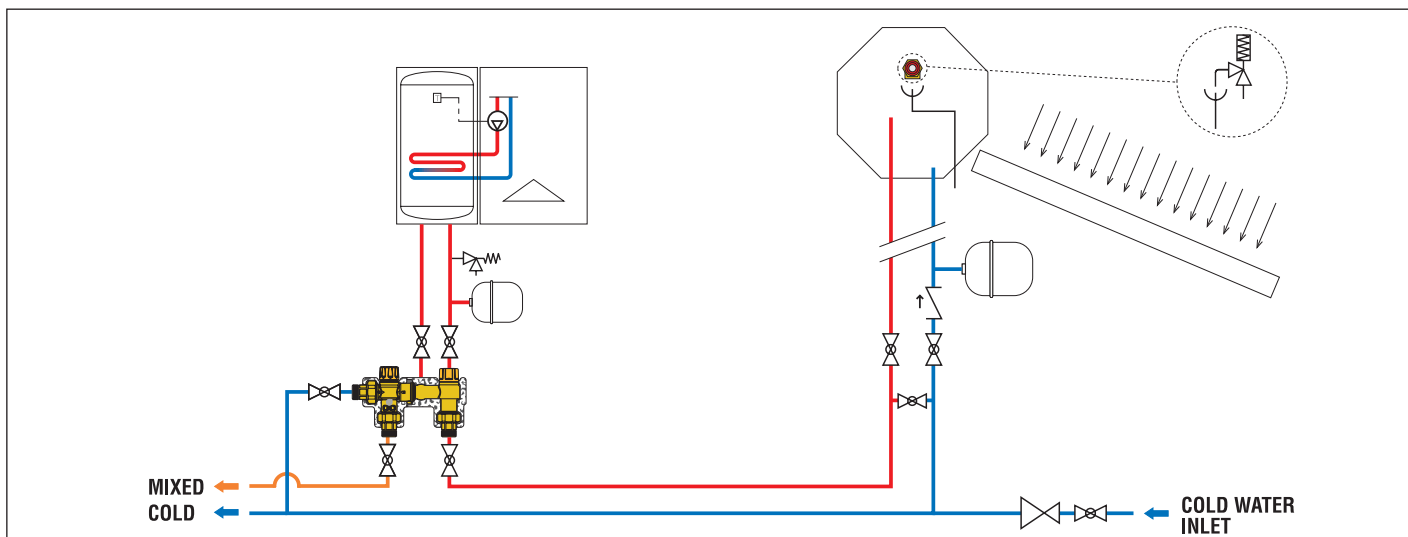

SOLAR STORAGE-TO-BOILER THERMOSTATIC CONNECTION KIT

263  
SOLARINCAL-T PLUS

tech. broch. 01164



Function

A thermostatic diverter valve, at the kit inlet, receives hot water coming from the solar water storage. Depending on the temperature setting, the valve diverts the water automatically and proportionally towards the user circuit or the **instantaneous boiler circuit, with thermal integration**. The valve modulates the flow rates to optimise the energy contained in the solar storage and reduces boiler operation times to a minimum.

A specific thermostatic control device limits the boiler inlet temperature to prevent it being switched on and off too often, which leads to hunting and irregular operation.

A thermostatic anti-scald mixing valve, at the kit outlet, constantly controls the temperature of the water sent to the user.

Hydraulic diagrams

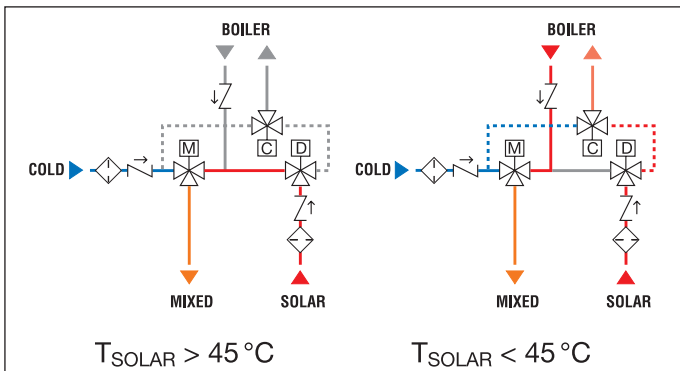

Solar storage-to-boiler connection kit, **with thermal integration**.

Consisting of:

- thermostatic anti-scald mixing valve, adjustable with knob, for solar thermal systems. Complete with strainers and check valves at the inlets;
- thermostatic diverter valve;
- thermostatic control device;
- pre-formed **shell protective cover**.

Mixing valve

CR dezincification resistant alloy body.

Max. working pressure: 10 bar.

Adjustment temperature range: 35–55 °C.

Max. inlet temperature: 100 °C.

Performance to standards NF 079 doc. 8, EN 15092, EN 1111, EN 1287.

Diverter valve

CR dezincification resistant alloy body.

Max. working pressure: 10 bar.

Factory setting: 45 °C.

Max. inlet temperature: 100 °C.

Control device

CR dezincification resistant alloy body.

Factory setting: 30 °C.

Max. inlet temperature: 85 °C.

PATENT.

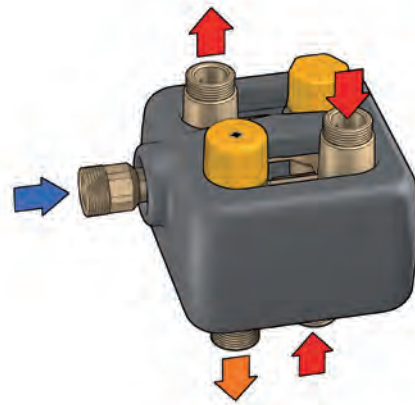

Code

263350 3/4"



1

-

Application diagram of SOLARINCAL-T Plus kit 263 series

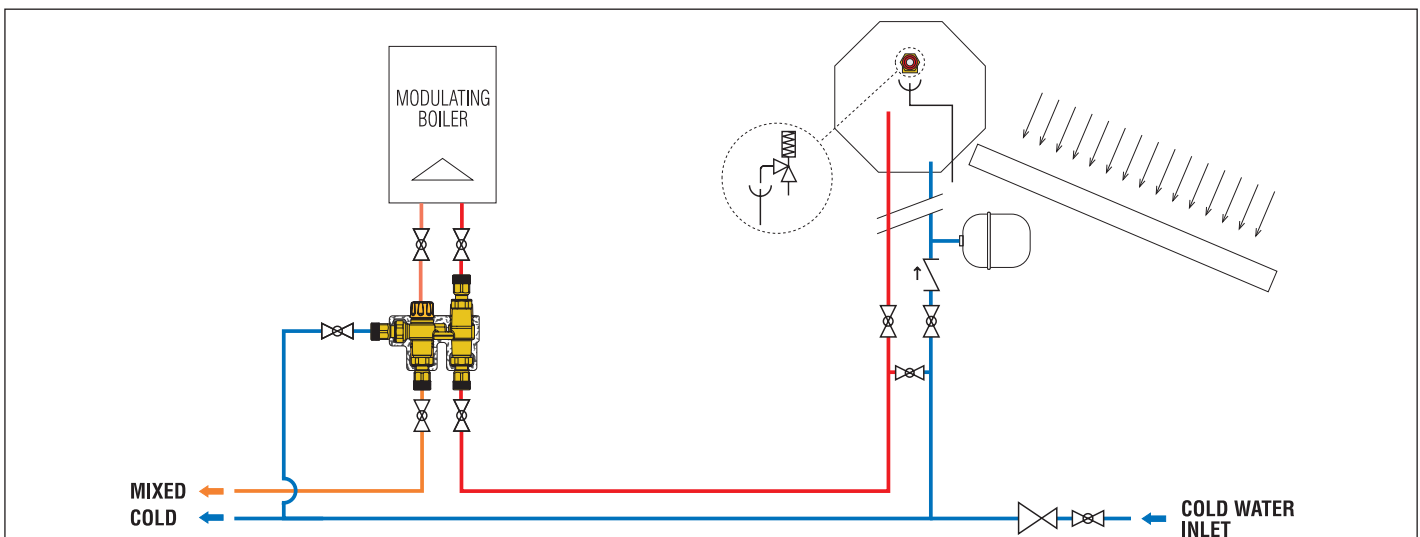





## COMPONENTS FOR GEOTHERMAL SYSTEMS

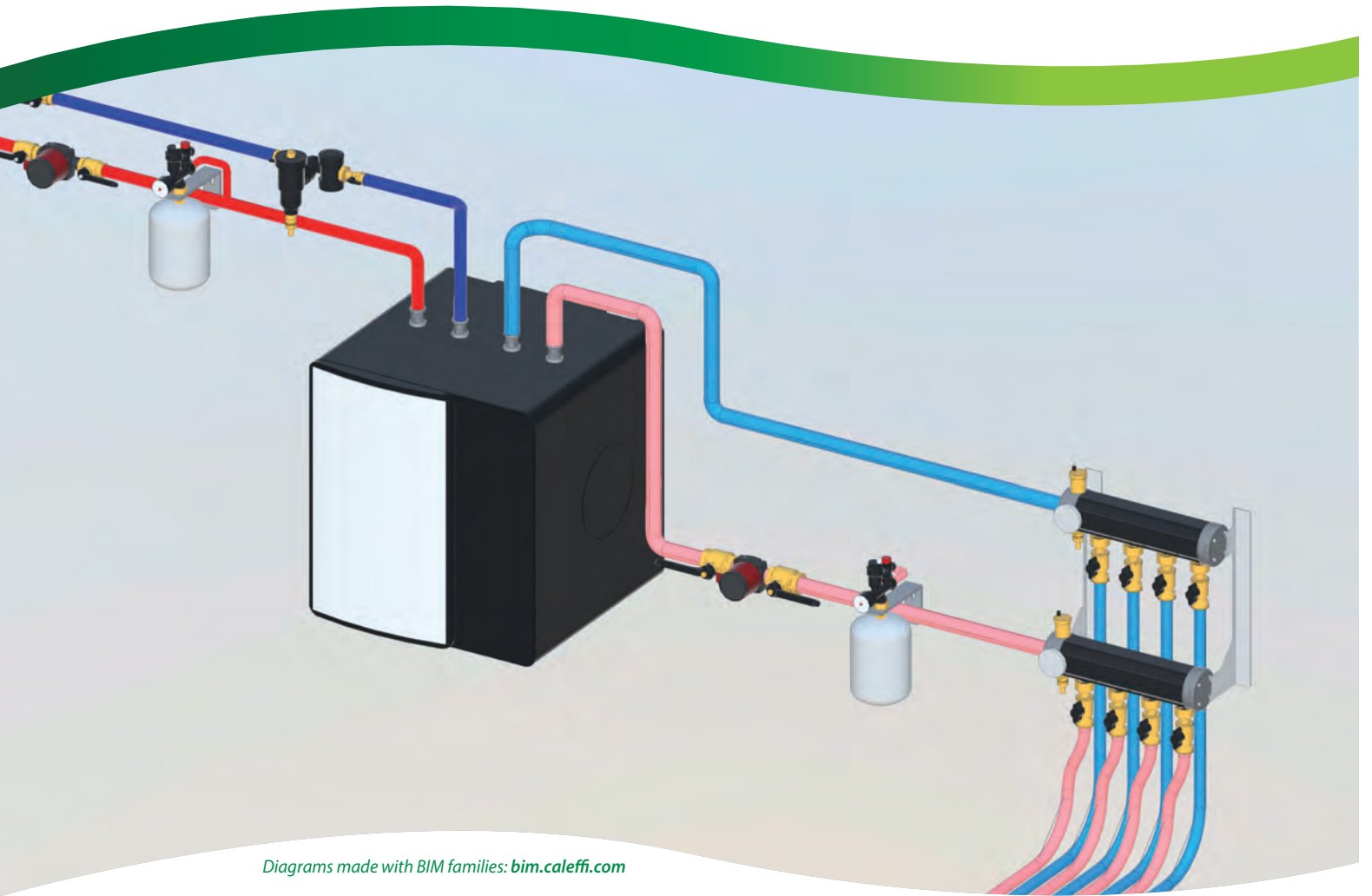

*Diagrams made with BIM families: [bim.caleffi.com](http://bim.caleffi.com)*

**Preassembled geothermal manifold**

**Modular geothermal manifold**

**Shut-off and balancing devices for geothermal manifold**

**PREASSEMBLED GEOTHERMAL MANIFOLD**

**110**

Preassembled geothermal manifold.  
Complete with:

- automatic air vents;
- temperature gauges Ø 80 mm;
- fill/drain cocks;
- flow and return manifolds in polymer;
- blind end plugs with insulation;
- stainless steel wall brackets;
- set of labels for direction of flow and circuit identification;
- wall fixing anchors.

tech. broch. 01221

Max. working pressure: 6 bar.  
Max. hydraulic test pressure: 10 bar.  
Temperature range: -10–60 °C.  
Ambient temperature range: -20–60 °C.  
Medium: water, glycol solutions, saline solutions.  
Max. percentage of glycol: 50 %.  
Manifold DN 50.  
Max. flow rate: 7 m<sup>3</sup>/h.  
Outlet centre distance: 100 mm.  
Outlet connections with mechanical seal for balancing valves 112 series.

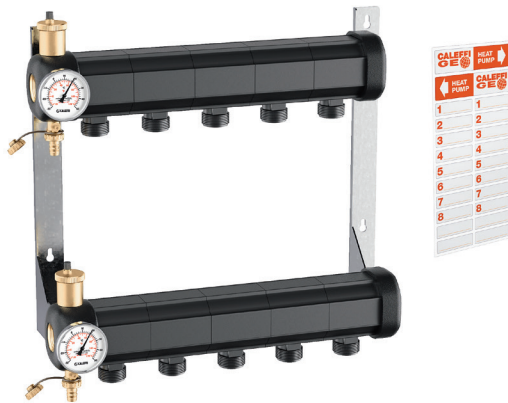

Code	Outlet connection				
<b>1107B5</b>	2 circuits	1 1/4"	42 p,2,5 TR	1	–
<b>1107C5</b>	3 circuits	1 1/4"	42 p,2,5 TR	1	–
<b>1107D5</b>	4 circuits	1 1/4"	42 p,2,5 TR	1	–
<b>1107E5</b>	5 circuits	1 1/4"	42 p,2,5 TR	1	–
<b>1107F5</b>	6 circuits	1 1/4"	42 p,2,5 TR	1	–
<b>1107G5</b>	7 circuits	1 1/4"	42 p,2,5 TR	1	–
<b>1107H5</b>	8 circuits	1 1/4"	42 p,2,5 TR	1	–

**For more than 8 outlet circuits, see the modular manifold**

**MODULAR GEOTHERMAL MANIFOLD**

**110**

tech. broch. 01221



Modular manifold single module in polymer.  
Max. working pressure: 6 bar.  
Max. hydraulic test pressure: 10 bar.  
Working temperature range: -10–60 °C.  
Ambient temperature range: -20–60 °C.  
Medium: water, glycol solutions, saline solutions.  
Max. percentage of glycol: 50 %.  
Manifold DN 50.  
Outlet connection: 42 p,2,5 TR.  
Outlet connections with mechanical seal for balancing valves 112 series.

tech. broch. 01221

**110**

Assembly kit for modular manifolds. Complete with:  
- brass end fitting with automatic air vent, fill/drain cock;  
- brass blind end plug;  
- pre-formed shell insulation;  
- screws and bolts for tie-rods and brackets;  
- set of labels for direction of flow and circuit identification;  
- temperature gauge with pocket (-30–50 °C);  
- No. 2 seal gaskets.  
Max. working pressure: 6 bar.  
System test max. pressure: 10 bar.  
Temperature range: -10–60 °C.  
Ambient temperature range: -20–60 °C.  
Medium: water, glycol solutions, saline solutions.  
Max. percentage of glycol: 50 %.  
Connections: 1 1/4" F.

Code		
<b>110700</b>	1	–

**110**

tech. broch. 01221



Stainless steel tie-rods for assembling modular manifolds.  
M8 threaded stainless steel bar.



Code			
<b>110012</b>	for manifold with 2 circuits	1	–
<b>110013</b>	for manifold with 3 circuits	1	–
<b>110014</b>	for manifold with 4 circuits	1	–
<b>110015</b>	for manifold with 5 circuits	1	–
<b>110016</b>	for manifold with 6 circuits	1	–
<b>110017</b>	for manifold with 7 circuits	1	–
<b>110018</b>	for manifold with 8 circuits	1	–
<b>110019</b>	for manifold with 9 circuits	1	–
<b>110020</b>	for manifold with 10 circuits	1	–
<b>110021</b>	for manifold with 11 circuits	1	–
<b>110022</b>	for manifold with 12 circuits	1	–

Code		
<b>110750</b>	1	–

**110**

tech. broch. 01221



Pair of stainless steel brackets to secure modular manifolds.  
Rapid wall coupling system. System for rapidly coupling the manifold on the brackets.  
With screws and plugs.

Code		
<b>110001</b>	1	–



## SHUT-OFF AND BALANCING DEVICES FOR GEOTHERMAL MANIFOLD 110 SERIES



### 112

tech. broch. 01235

Balancing valve with flow meter.  
Complete with fitting for polyethylene pipe.  
Direct reading of flow rate.  
Ball valve for flow rate setting.  
Graduated scale flow meter with magnetic movement flow rate indicator.  
Brass valve body and flow meter.  
Connection to manifold: female connections with captive nut 42 p.2,5 TR.  
Max. working pressure: 10 bar.  
Temperature range: -10–40 °C.  
Ambient temperature range: -20–60 °C.  
Medium: water, glycol solutions, saline solutions.  
Max. percentage of glycol: 50 %.  
Accuracy: ± 10 %.

Code	Scale (m <sup>3</sup> /h)		
112621	42 p.2,5 TR x Ø 25	0,3–1,2	1 –
112631	42 p.2,5 TR x Ø 32	0,3–1,2	1 –
112641	42 p.2,5 TR x Ø 40	0,3–1,2	1 –

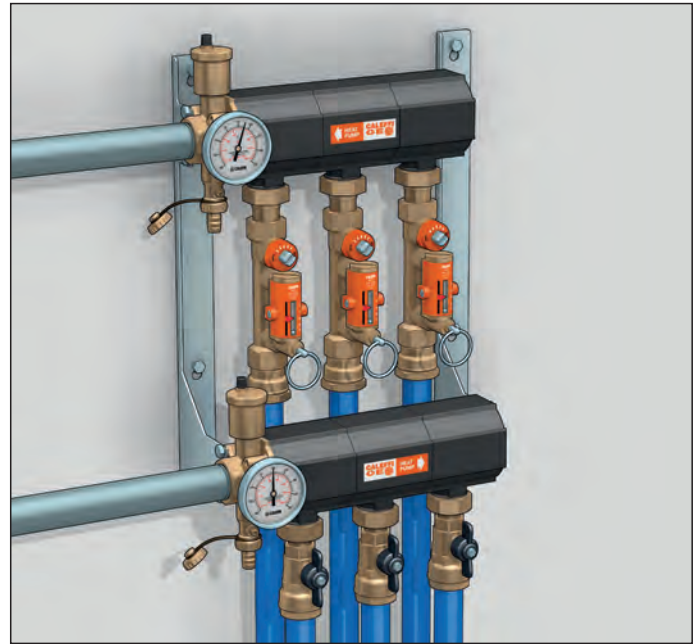



The use of a flow meter greatly simplifies the process of system balancing, since the flow rate can be measured and controlled at any time and there is no need for differential pressure gauges or reference charts.



### 112

tech. broch. 01235



Insulation for balancing valves.  
Material: closed cell expanded PE-X.  
Thickness: 10 mm.  
Density: inner part 30 kg/m<sup>3</sup>, outer part 80 kg/m<sup>3</sup>.  
Thermal conductivity (DIN 52612): at 0 °C: 0,038 W/(m·K); at 40 °C: 0,045 W/(m·K).  
Coefficient of resistance to water vapour (DIN 52615): > 1.300.  
Working temperature range: 0–100 °C.  
Reaction to fire (DIN 4102): class B2.

Code	Use		
112001	Ø 25 - Ø 32	1	–
112003	Ø 40	1	–

### 871





Ball valve complete with fitting for polyethylene pipe.  
Brass body.  
Connection to manifold: female connection with captive nut 42 p.2,5 TR.  
Max. working pressure: 16 bar.  
Working temperature range: -10–40 °C.  
Ambient temperature range: -20–60 °C.  
Medium: water, glycol solutions, saline solutions.  
Max. percentage of glycol: 50 %.  
Fitted for 111 series insulation.

Code			
871025	42 p.2,5 TR x Ø 25	1	–
871032	42 p.2,5 TR x Ø 32	1	–
871040	42 p.2,5 TR x Ø 40	1	–



### 110

Union with gasket.  
Max. working pressure: 16 bar.  
Max. working temperature: 40 °C.

Code			
110050	42 p.2,5 TR x 3/4"	1	–
110060	42 p.2,5 TR x 1"	1	–



## COMPONENTS FOR BIOMASS SYSTEMS

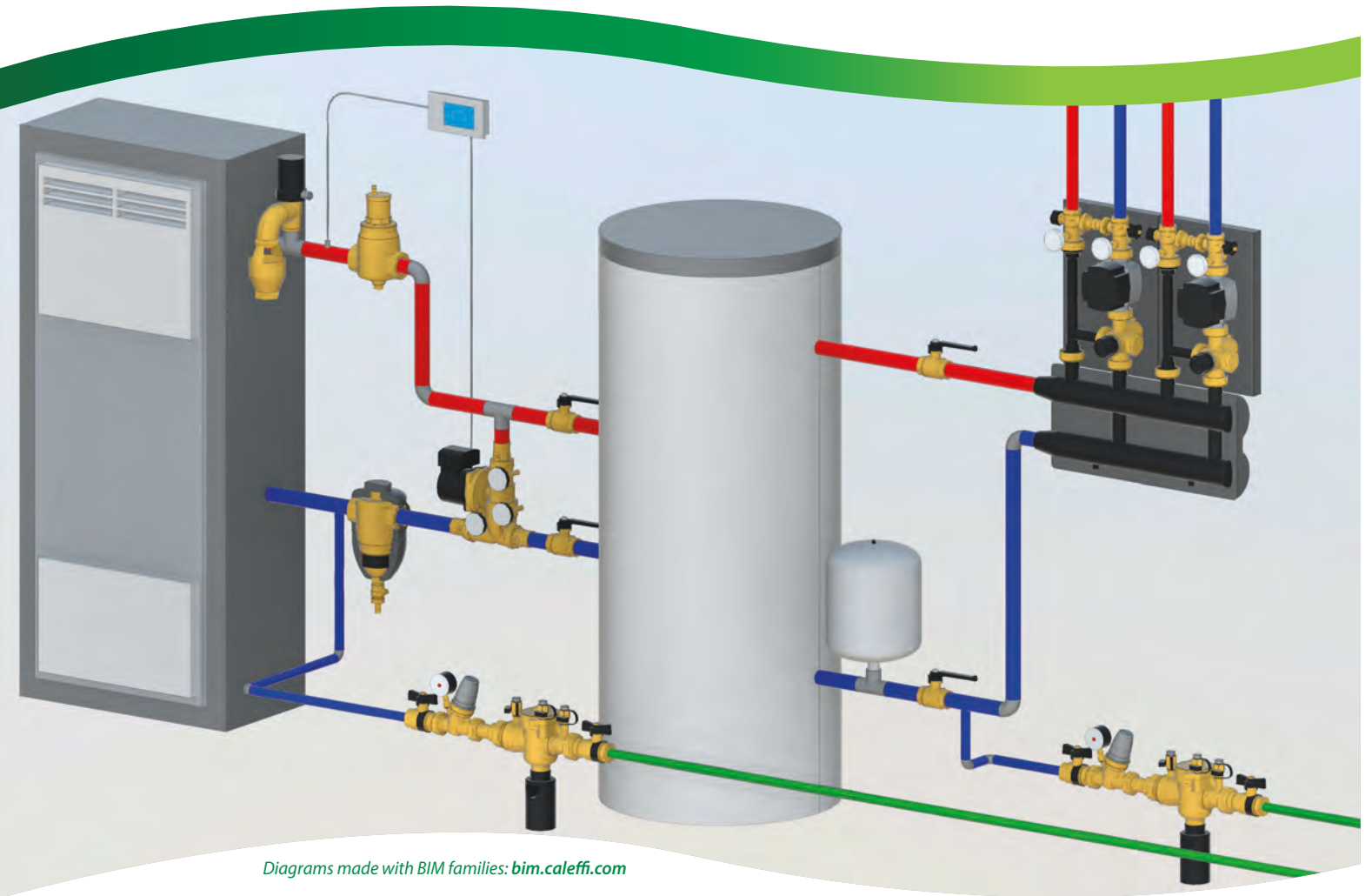

*Diagrams made with BIM families: [bim.caleffi.com](http://bim.caleffi.com)*

### **Safety devices**

**Anti-condensation valve**

**Anti-condensation circulation unit**

**Anti-condensation recirculation and distribution unit**

**Connection and energy management unit (heating version)**

**Connection and energy management compact unit (heating version)**

**Digital regulator for systems with solid fuel generator**

**CALEFFI**  
**BIOMASS**

SAFETY DEVICES



542

tech. broch. 01001

Temperature relief valve, with fail-safe action. Manual reset for burner switch off or alarm activation. Working pressure:  $0,3 \text{ bar} \leq P \leq 10 \text{ bar}$ . Temperature range: 5–100 °C. Settings temperature: 98 °C, 99 °C. Certified and calibrated to INAIL. Discharge rating: 1 1/2" x 1 1/4" - 136 kW. 1 1/2" x 1 1/2" - 419 kW.



Code	Setting		
542870	1 1/2" M x 1 1/4" F 98 °C	1	10
542880	1 1/2" M x 1 1/2" F 99 °C	1	10

Function

The temperature relief valve discharges the system water on reaching the setting temperature. Equipped with positive action. It can be used with non-pulverized solid fuel generators with open or closed vessel in accordance with current regulations.

INAIL - Ex ISPEL reference standards

According to the provisions of Collection R Ed. 2009, concerning "central heating systems using hot water with temperatures no greater than 110 °C and a maximum nominal heat output greater than 35 kW", the use of the temperature relief valve is contemplated in the following cases:

Open vessel systems

- Systems with generators stoked with non-pulverized solid fuel, in place of the consumption water heater or emergency exchanger (chap. R.3.C., point 2.1, letter i2).

Closed vessel systems

- Thermal systems with generators stoked with non-pulverized solid fuels up to a nominal heat output of 100 kW with partial cut-off in place of the residual power dissipation device (chap. R.3.C., point 3.2).

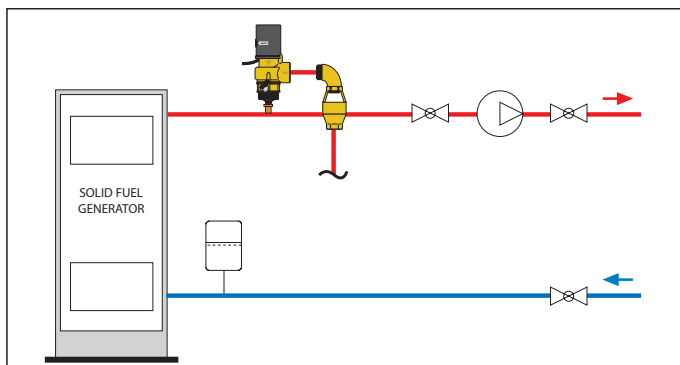
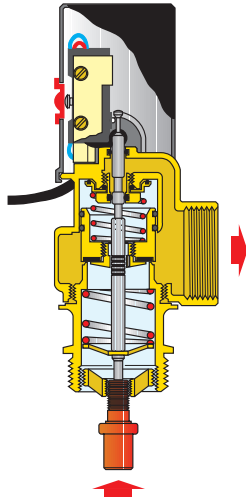

543

tech. broch. 01057

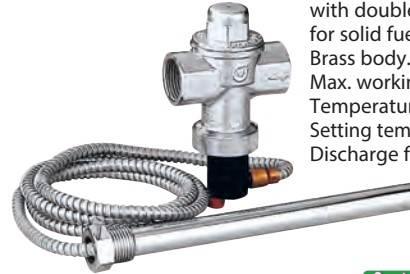

Temperature safety relief valve, with double safety sensor, for solid fuel generators. Brass body. Chrome plated. Max. working pressure: 10 bar. Temperature range: 5–110 °C. Setting temperature: 98 °C (0/-4 °C). Discharge flow rate with  $\Delta p$  of 1 bar and  $T=110 \text{ °C}$ : 3000 l/h. Capillary length: 1300 mm. Certified to EN 14597.



Code	Setting		
543513	3/4" F 98 °C	1	10
543503	3/4" F 98 °C yellow brass body	1	10

Function

The temperature safety relief valve limits the water temperature in solid fuel generators equipped with a built-in storage or emergency exchanger (for immediate cooling). On reaching the setting temperature, the valve opens the flow of mains water through the emergency exchanger or built-in storage unit, so as to draw off the excess heat and thereby lower the temperature of the system water contained in the boiler jacket.

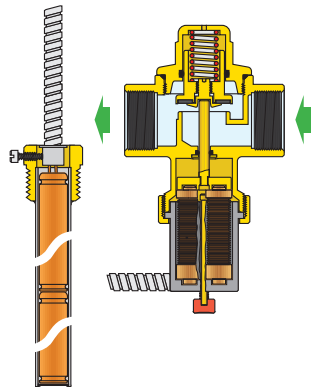

Reference standards

Its use is contemplated in the INAIL - Ex ISPEL standards, Collection R - ed. 2009, chapter R.3.C., point 2.1, letter i2; point 3.1, letter i; point 3.3. The valve complies with EN 14597, it can be combined with solid fuel generators with a heat output of less than 100 kW, used according to the system provisions of the standards EN 12828, UNI 10412-2 and EN 303-5.

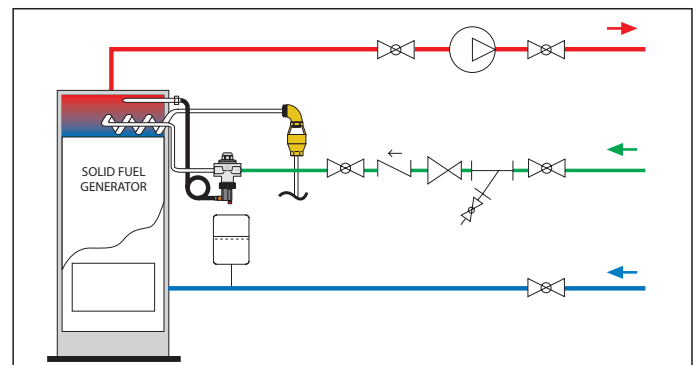

SAFETY DEVICES

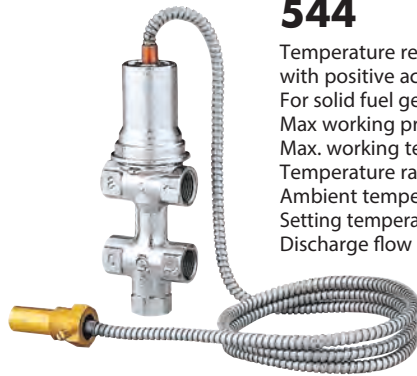

544

tech. broch. 01058

Temperature relief valve, with positive action with automatic filling. For solid fuel generators. Max working pressure: 6 bar. Max. working temperature: 110 °C. Temperature range: 5–110 °C. Ambient temperature range: 1–50° C. Setting temperature: 100 °C (0/-5 °C). Discharge flow rate with Δp of 1 bar and T=110 °C: 1600 l/h. Capillary length: 1300 mm.

Code	Setting		
544400	1/2"	100 °C	1 10

Function

On reaching the setting temperature, the temperature relief valve discharges the water of the system with a solid fuel generator. The device integrates in a single group a temperature relief valve with a positive safety remote sensor and a filling valve. The discharge of water enables limiting the system water temperature, while the filling inlet enables the replacement of the discharged flow rate.

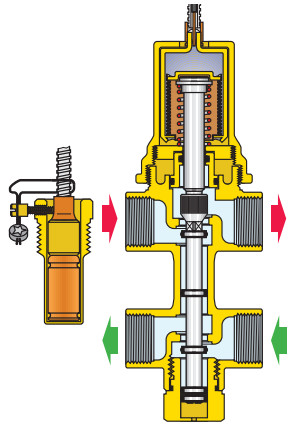

Reference standards

Used when there is no emergency exchanger and for heat outputs < 35 kW (Italy).

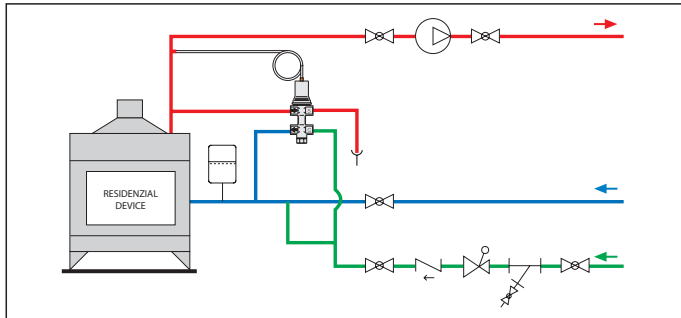

544

Temperature relief valve with automatic filling for solid fuel generators, with knob for manual discharge. Max. working pressure: 6 bar. Max. working temperature: 120 °C. Setting temperature: 100 °C (0/-5 °C). Discharge flow rate with Δp of 1 bar and T=110 °C: 1800 l/h.

Code	Setting		
544501	3/4"	100 °C	1 -

Function

The device integrates in a single group a temperature relief valve and a filling valve that operate simultaneously by means of a sensor integrated in the valve body. On reaching the setting value, the valve opens the discharge outlet to eliminate the excess heat and, at the same time, the filling inlet to replace the discharged flow rate of the system water.

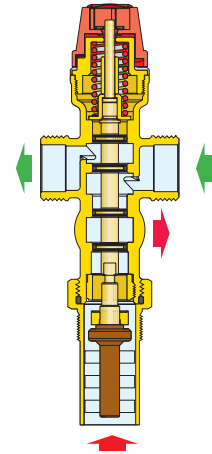

Reference standards

Used when there is no emergency exchanger and for heat outputs < 35 kW (Italy).

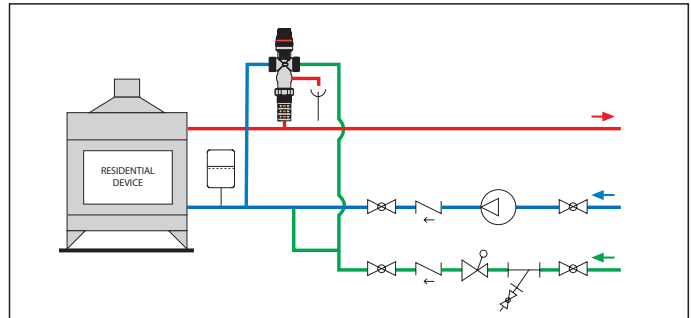

529

tech. broch. 01226

Draught regulating valve. Male threaded connection. Adjustment temperature range: 30–90 °C. Certified to EN 14597.



Code		Pocket length (mm)		
529050	3/4" M ISO 7/1	58	1	10
529151	3/4" M ISO 7/1	78	1	10

Code		Pocket length (mm)		
529150	3/4" M ISO 7/1	58	1	10

Function

The draught regulating valve, installed on the generator with the thermostatic element immersed in the medium, automatically adjusts the flow rate of the comburent air to provide a more regular and complete combustion.

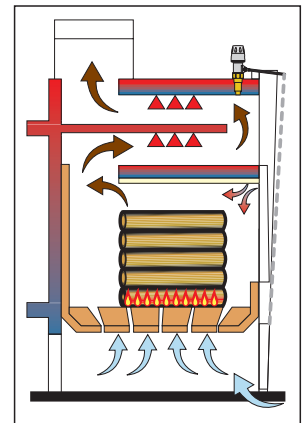

## ANTI-CONDENSATION VALVE

**280**

tech. broch. 01223



Anti-condensation valve with thermostatic control of the return temperature to solid fuel generators. Brass body. Male union connections. Max. percentage of glycol: 50 %. Max. working pressure: 10 bar. Temperature range: 5–100 °C. Settings: 45 °C, 55 °C, 60 °C, 70 °C. Setting accuracy: ± 2 °C. By-pass complete closing temperature:  $T_{mix} = T_{set} + 10\text{ °C} = Tr.$

PCT INTERNATIONAL APPLICATION PENDING

Code	DN	Connection	Kv (m <sup>3</sup> /h)	Max. recommended power		
28005.	20	3/4"	3,2	10 kW	1	10
28026.	20	1"	3,2	10 kW	1	10
28006.	25	1"	9	35 kW	1	5
28007.	32	1 1/4"	12	45 kW	1	5

### Valve selection

The valve selection should be made according to the Kv value (corresponding to a specific DN body size) and not only according to the threaded connections. Given the system flow rate, the corresponding head losses on the valve should be calculated by using the Kv value. The sum of the head losses on the valve and the head losses of the rest of the system should be compatible with the available head of the generator pump.

### Code completion

Setting	45 °C	55 °C	60 °C	70 °C
•	4	5	6	7



Spare thermostats for anti-condensation valve.

Code	Setting	Use		
F29629	45 °C	code 28005. / 28026.	1	–
F29630	55 °C	code 28005. / 28026.	1	–
F29631	60 °C	code 28005. / 28026.	1	–
F29632	70 °C	code 28005. / 28026.	1	–
F29633*	45 °C	code 28006. / 28007.	1	–
F29634*	55 °C	code 28006. / 28007.	1	–
F29635*	60 °C	code 28006. / 28007.	1	–
F29636*	70 °C	code 28006. / 28007.	1	–

\* Also use for 281, 282, 2850, 2851, 2853, 2855 series

### Thermostat replacement to modify setting

The adjustment sensor can easily be removed for maintenance or to change the set, with no need to remove the valve body from the piping.

### Installation

The valve can be fitted on both sides of the generator in any position, vertical or horizontal. **Installation is recommended on the return to the generator in mixing mode;** it is also allowed on the flow from the generator in diverter mode according to the needs of system control.

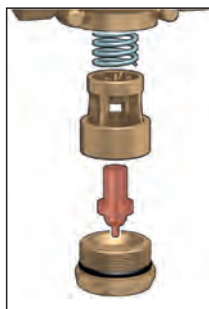

### Function

The anti-condensation valve, used in heating systems with a solid fuel generator, automatically regulates at the set value the temperature of the water returning to the generator. Keeping the boiler at a high temperature **prevents condensation of the water vapour contained in the flue gas.** Condensation produces tarry deposits that, accumulating on the metal surfaces of the flue gas-system water exchanger, cause corrosion, reduce the thermal efficiency of the flue gas-system water exchanger and are a source of danger for the flue gas chimney as they are flammable. The anti-condensation valve gives the generator a longer life and ensures greater efficiency.

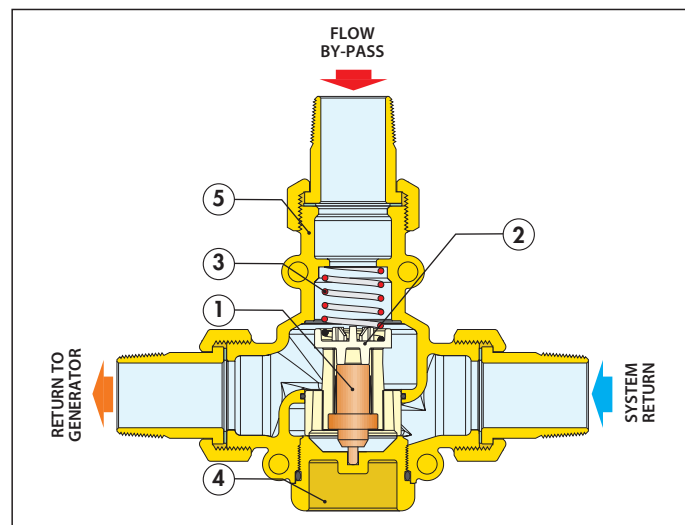
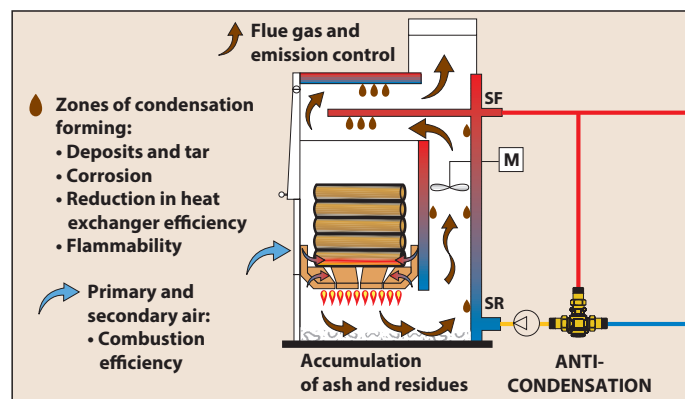

### Characteristics components

- 1) Thermostatic sensor
- 2) Obturator
- 3) Spring
- 4) Plug
- 5) Valve body

### Installation in mixing mode (anti-condensation)

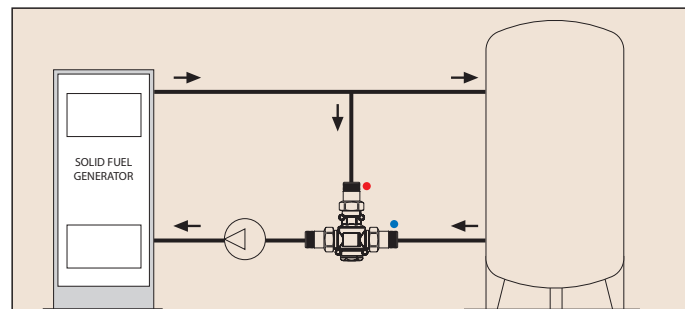



ANTI-CONDENSATION RECIRCULATION AND DISTRIBUTION UNIT

281

tech. broch. 01224

Anti-condensation recirculation and distribution unit, with thermostatic control of the return temperature to solid fuel generators. Brass body.

**With insulation.**

- Female union connections.
- Medium: water, glycol solutions.
- Max. percentage of glycol: 50 %.
- Temperature range: 5–100 °C.
- Max. working pressure: 10 bar.
- Max. recommended flow rate: 2 m³/h.
- Temperature gauge scale: 0–120 °C.

**Anti-condensation valve**

- Temperature range: 5–100 °C.
- Settings: 45 °C, 55 °C, 60 °C, 70 °C.
- Setting accuracy: ± 2 °C.
- By-pass complete closing temperature:  $T_{mix} = T_{set} + 10 °C = Tr.$

**Pump**

High-efficiency pump: WILO PARA MS/7.



Code	DN	Connection		
28106.WYP	25	1" F	with pump WILO PARA MS/7	1 -
28107.WYP	25	1 1/4" F	with pump WILO PARA MS/7	1 -

**Unit sizing**

The unit should be selected according to the head available at the unit connections, depending on the DN, and not only according to the threaded connections. Given the system head losses, the available head of the unit pump should be evaluated.

Code		
F29806	spare rotor for unit 281 series	1 -

**Code completion**

Setting	45 °C	55 °C	60 °C	70 °C
	4	5	6	7

For spare thermostats see page 350

**Function**

The anti-condensation recirculation and distribution unit enables the connection of the solid fuel generator to the user system (direct or with inertial storage). It controls the return temperature to the generator to avoid condensation, by means of the built-in thermostatic device.

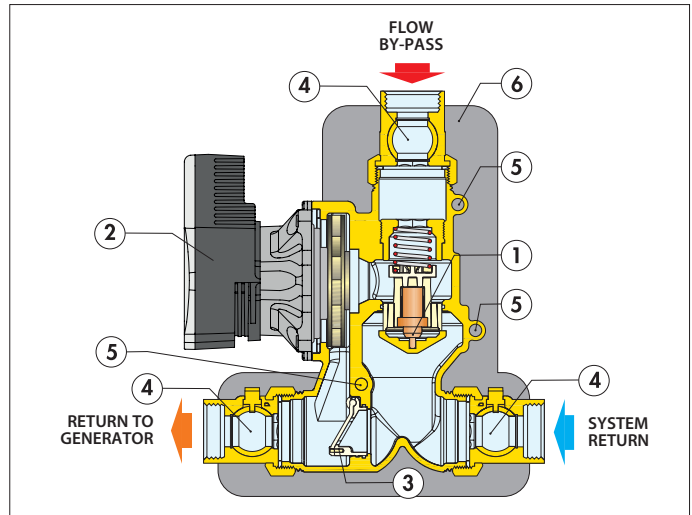

**Characteristics components**

- 1) Anti-condensation thermostatic device
- 2) High-efficiency pump
- 3) Natural circulation clapet valve
- 4) Union with built-in ball valve
- 5) Temperature gauge housing
- 6) Insulation

**Construction details**

**Single casting and reversibility**

The compact brass single casting, that houses the pump and functional components, enables immediate installation of the device, either on the right or left of the solid fuel generator, respecting the flow directions as shown. The temperature gauges can be extracted from the housings and re-inserted in the same position on the back side of the unit.

**Anti-condensation valve**

This device incorporates a thermostatic sensor to control the temperature of the water returning to the solid fuel generator so as to prevent condensation. The sensor has been specifically realised to be removed from the valve body for maintenance or replacement if necessary.

**Natural circulation clapet valve**

The function of this clapet device is to ensure natural circulation of the medium in the event of pump stop due to an electric supply failure. When the pump is active, the thrust of medium keeps the valve closed, forcing the water to flow through the anti-condensation thermostatic valve. If the event of pump stop, when the water within the generator is at high temperature, a natural circulation of the water begins, by-passing the anti-condensation valve, thus preventing the temperature in the generator from reaching dangerous high levels. The unit is provided with natural circulation valve locked. To activate its function, remove the locking screw.

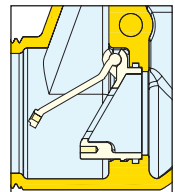

## SOLID FUEL GENERATOR-TO-GAS BOILER CONNECTION KIT

Application diagram of kit SOLARINCAL 265 series with solid fuel generator

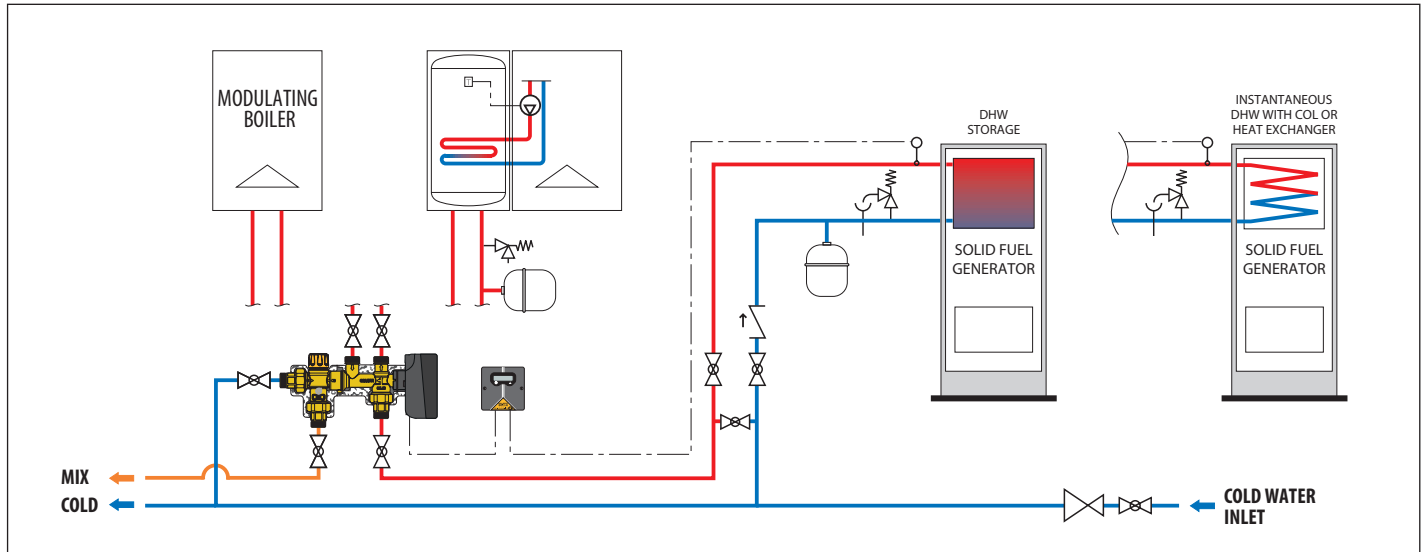

Application diagram of kit SOLARINCAL-T 262 series with solid fuel generator

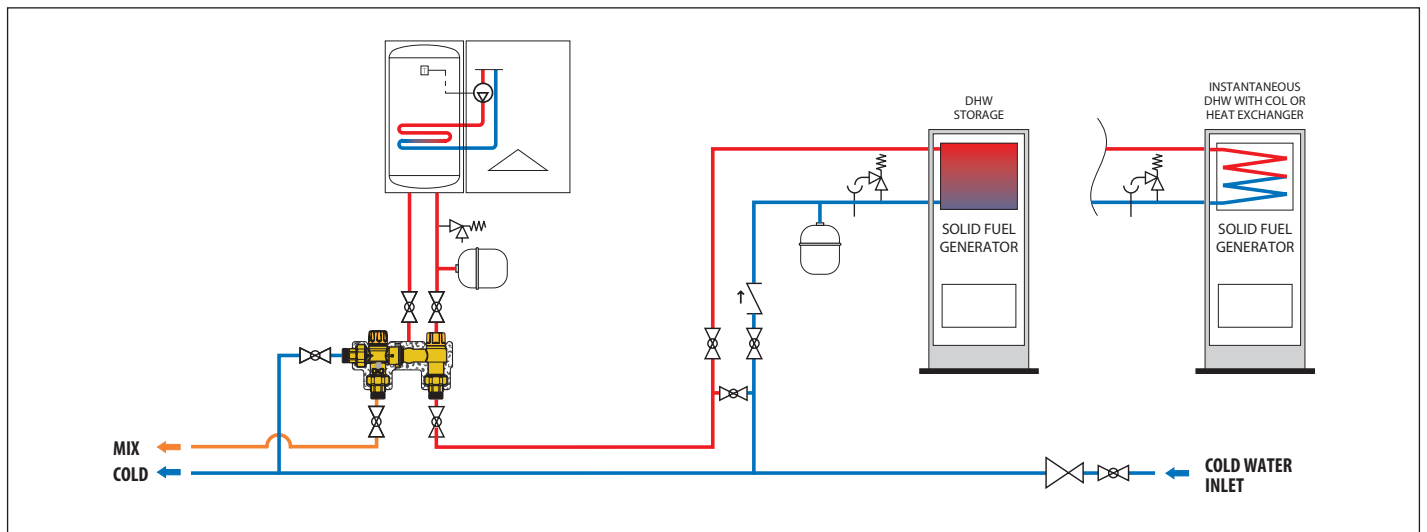

Application diagram of kit SOLARINCAL-T PLUS 263 series with solid fuel generator

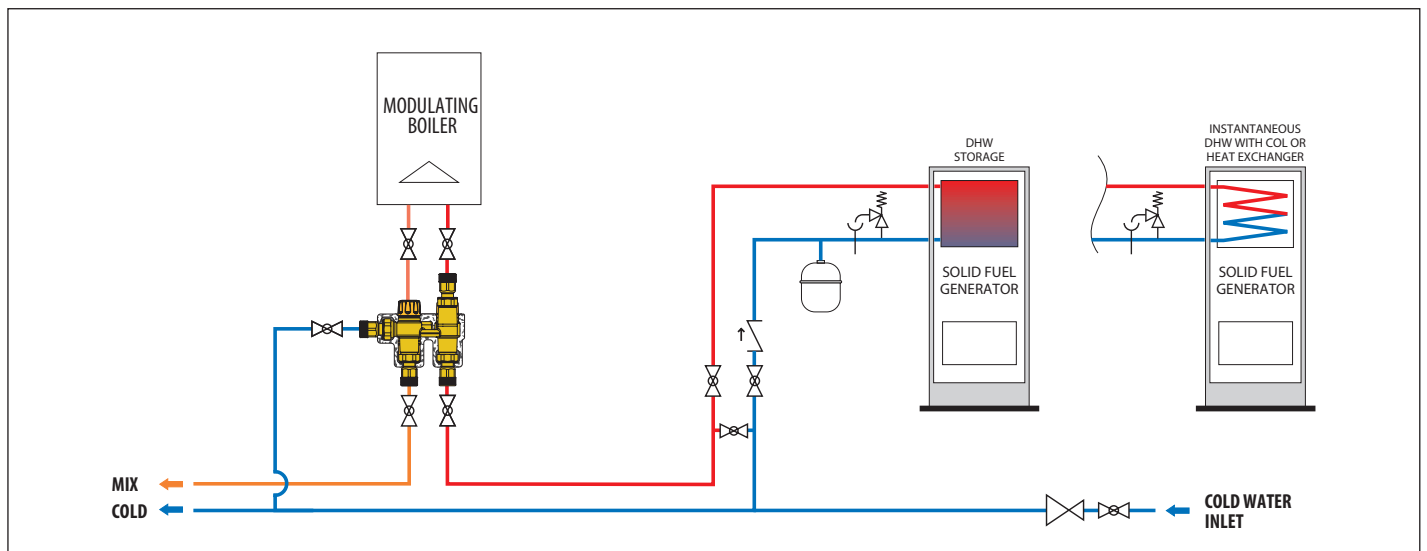

## SPARE PARTS

FOR SPARE PARTS, PLEASE CONTACT THE APPROPRIATE DEPARTMENT

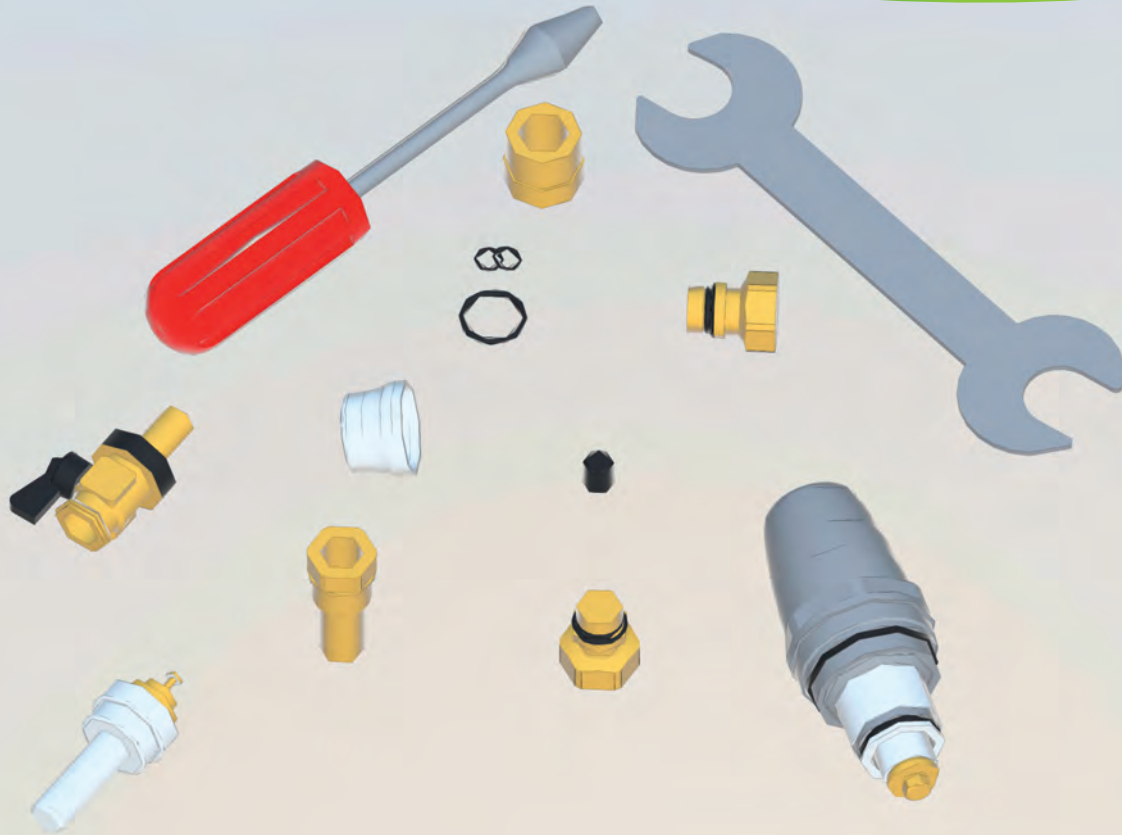



FITTING COUPLING  
PRODUCT DIMENSIONS are available on [www.caleffi.com](http://www.caleffi.com)

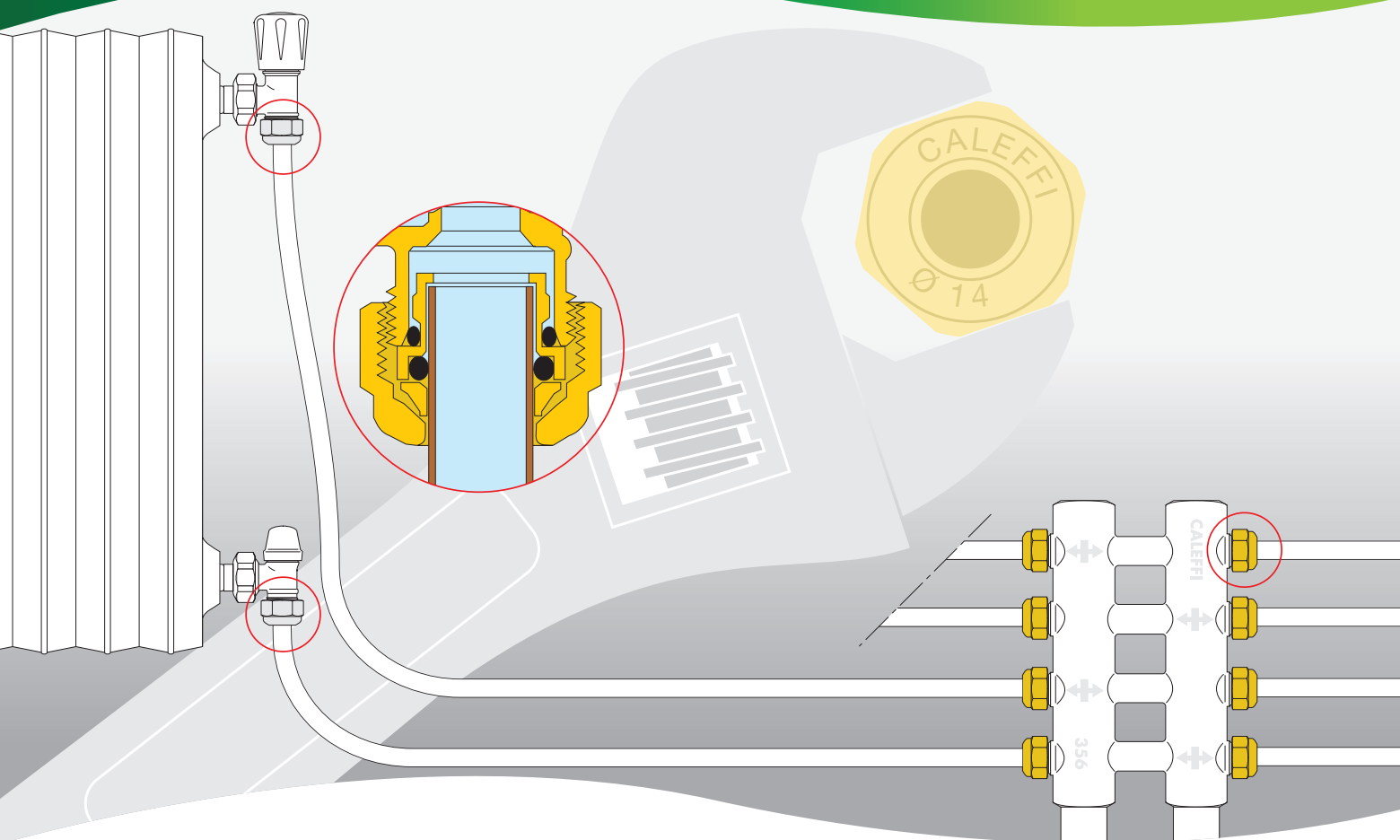

CHROME PLATED BRASS FITTINGS

23 p.1,5 pipes connection



**6790 DARGAL**

Fitting for multilayer plastic pipe with continuous high temperature use.

For a correct use, adjust the multilayer pipe diameter before installation using the Caleffi calibrator 679 series.

Code

679014	23 p.1,5 - Ø 14x2
679024	23 p.1,5 - Ø 16x2
679025	23 p.1,5 - Ø 16x2,25
679044	23 p.1,5 - Ø 18x2
679064*	23 p.1,5 - Ø 20x2
679065*	23 p.1,5 - Ø 20x2,25
679066*	23 p.1,5 - Ø 20x2,5
679067*	23 p.1,5 - Ø 20x2,9 (REHAU pipe)

\* With metal ring



**6810 DARGAL**

Self-adjustable diameter fitting for single and multilayer plastic pipes.

Code

		Ø <sub>inside</sub>	Ø <sub>outside</sub>
681000	23 p.1,5	7,5- 8	12-14
681002	23 p.1,5	9 - 9,5	14-16
681001	23 p.1,5	9,5-10	12-14
681006	23 p.1,5	9,5-10	14-16
681015	23 p.1,5	10,5-11	14-16
681017	23 p.1,5	10,5-11	16-18
681024	23 p.1,5	11,5-12	14-16
681026	23 p.1,5	11,5-12	16-18
681035	23 p.1,5	12,5-13	16-18
681044	23 p.1,5	13,5-14	16-18



**6810 DARGAL**

Self-adjustable diameter fitting for single and multilayer plastic pipes. High chrome finish.

Code

		Ø <sub>inside</sub>	Ø <sub>outside</sub>
681101	23 p.1,5	9,5-10	12-14,4
681124	23 p.1,5	11,5-12	14-16,4



**4470**

Pre-assembled compression fitting, for annealed copper, hard copper, brass, mild and stainless steel. With O-Ring seal.

Code

447010	23 p.1,5 - Ø 10
447012	23 p.1,5 - Ø 12
447014	23 p.1,5 - Ø 14
447015	23 p.1,5 - Ø 15
447016	23 p.1,5 - Ø 16



**4370**

Compression fitting, for annealed copper, hard copper, brass, mild and stainless steel. With O-Ring seal.

Code

437010	23 p.1,5 - Ø 10
437012	23 p.1,5 - Ø 12
437014	23 p.1,5 - Ø 14
437015	23 p.1,5 - Ø 15
437016	23 p.1,5 - Ø 16



**4371**

Compression fitting, for annealed copper, hard copper, brass, mild and stainless steel. With O-Ring seal. High chrome finish.

Code

437112	23 p.1,5 - Ø 12
437114	23 p.1,5 - Ø 14
437115	23 p.1,5 - Ø 15
437116	23 p.1,5 - Ø 16



**4380**

Compression fitting, for copper pipes. With PTFE seal.

Code

438010	23 p.1,5 - Ø 10
438012	23 p.1,5 - Ø 12
438014	23 p.1,5 - Ø 14
438015	23 p.1,5 - Ø 15
438016	23 p.1,5 - Ø 16
438018	23 p.1,5 - Ø 18 with metal olive



**4390**

Fitting for copper pipe, with gasket. Chrome plated. Do not use with valves 232 series.

Code

439010	23 p.1,5 - Ø 10
439012	23 p.1,5 - Ø 12
439014	23 p.1,5 - Ø 14
439016	23 p.1,5 - Ø 16

23 p.1,5 M - Ø 18

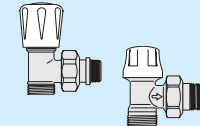

Series: 338

- 339
- 425
- 426
- 222 232
- 223 233
- 227 237

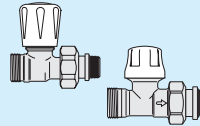

Series: 4001

- 4003
- 4004
- 4005

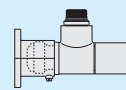

Series: 340

- 341
- 342
- 343



Series: 456

- 455
- 4501
- 348
- 452
- 328

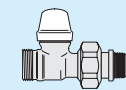
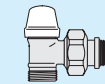

Series: 382

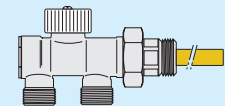
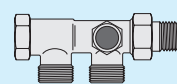
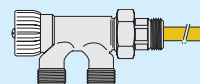
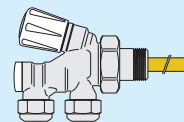

CHROME PLATED BRASS FITTINGS

3/4" pipes connection

**6792 DARCAL**  
 Fitting for multilayer plastic pipe with continuous high temperature use.



For a correct use, adjust the multilayer pipe diameter before installation using the Caleffi calibrator 679 series.

Code	
679264	3/4" - Ø 20x2
679265	3/4" - Ø 20x2,25
679266	3/4" - Ø 20x2,5

**4375**  
 Compression fitting, for annealed copper, hard copper, brass, mild and stainless steel. With O-Ring seal.



Code	
437510	3/4" - Ø 10
437512	3/4" - Ø 12
437514	3/4" - Ø 14
437515	3/4" - Ø 15
437516	3/4" - Ø 16
437518	3/4" - Ø 18

**6815 DARCAL**  
 Self-adjustable diameter fitting for single and multilayer plastic pipes.



Code		Ø <sub>inside</sub>	Ø <sub>outside</sub>
681502	3/4"	7,5- 8	12-14
681500	3/4"	9 - 9,5	14-16
681501	3/4"	9,5-10	12-14
681506	3/4"	9,5-10	14-16
681515	3/4"	10,5-11	14-16
681517	3/4"	10,5-11	16-18
681524	3/4"	11,5-12	14-16
681526	3/4"	11,5-12	16-18
681535	3/4"	12,5-13	16-18
681537	3/4"	12,5-13	18-20
681546	3/4"	13,5-14	18-20
681555	3/4"	14,5-15	18-20
681556	3/4"	15 -15,5	18-20
681564	3/4"	15,5-16	18-20

**4385**  
 Compression fitting, for copper pipes. With PTFE seal.



Code	
438512	3/4" - Ø 12
438514	3/4" - Ø 14
438515	3/4" - Ø 15
438516	3/4" - Ø 16
438518	3/4" - Ø 18

3/4" M - Ø 18



- Series: 3010  
 3011  
 3012  
 3013  
 3014  
 3015

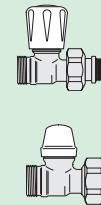

- Codes: 338452  
 339452  
 340452  
 342452  
 343452

BRASS FITTINGS

23 p.1,5 pipes connection



**6791 DARGAL**

Fitting for multilayer plastic pipes with continuous high temperature use.

For a correct use, adjust the multilayer pipe diameter before installation using the Caleffi calibrator 679 series.

Code	
679114	23 p.1,5 - Ø 14x2
679124	23 p.1,5 - Ø 16x2
679125	23 p.1,5 - Ø 16x2,25
679144	23 p.1,5 - Ø 18x2



**4460**

Pre-assembled compression fitting, for annealed copper, hard copper, brass, mild and stainless steel pipes. With O-Ring seal.

Code	
446010	23 p.1,5 - Ø 10
446012	23 p.1,5 - Ø 12
446014	23 p.1,5 - Ø 14
446015	23 p.1,5 - Ø 15
446016	23 p.1,5 - Ø 16

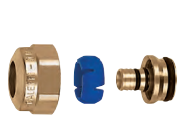

**6800 DARGAL**

Self-adjustable diameter fitting for single and multilayer plastic pipes.

Code		Ø <sub>inside</sub>	Ø <sub>outside</sub>
680000	23 p.1,5	7,5- 8	12-14
680002	23 p.1,5	9 - 9,5	14-16
680001	23 p.1,5	9,5-10	12-14
680006	23 p.1,5	9,5-10	14-16
680015	23 p.1,5	10,5-11	14-16
680017	23 p.1,5	10,5-11	16-18
680024	23 p.1,5	11,5-12	14-16
680026	23 p.1,5	11,5-12	16-18
680035	23 p.1,5	12,5-13	16-18
680044	23 p.1,5	13,5-14	16-18



**3470**

Compression fitting, for annealed copper, hard copper, brass, mild and stainless steel pipes. With O-Ring seal.

Code	
347010	23 p.1,5 - Ø 10
347012	23 p.1,5 - Ø 12
347014	23 p.1,5 - Ø 14
347015	23 p.1,5 - Ø 15
347016	23 p.1,5 - Ø 16

**6800 DARGAL**

Self-adjustable diameter fitting for single and multilayer plastic pipes.



Code		Ø <sub>inside</sub>	Ø <sub>outside</sub>
680055	23 p.1,5	14,5-15	18-20
680064	23 p.1,5	15,5-16	18-20

23 p.1,5 M - Ø 18



Series: 350  
351  
349

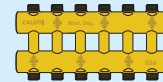

Series: 356  
357  
385  
161



Series: 354



BRASS FITTINGS

3/4" pipes connection



**6795 DARGAL**

Fitting for multilayer plastic pipes with continuous high temperature use.

For a correct use, adjust the multilayer pipe diameter before installation using the Caleffi calibrator 679 series.

Code	
679514	3/4" Ø 14 x 2
679524	3/4" Ø 16 x 2
679525	3/4" Ø 16 x 2,25
679544	3/4" Ø 18 x 2
679564	3/4" Ø 20 x 2
679565	3/4" Ø 20 x 2,25
679566	3/4" Ø 20 x 2,5



**6805 DARGAL**

Self-adjustable diameter fitting for single and multilayer plastic pipes.

Code		Ø <sub>inside</sub>	Ø <sub>outside</sub>
680507	3/4"	7,5- 8	10,5-12
680502	3/4"	7,5- 8	12 -14
680503	3/4"	8,5- 9	12 -14
680500	3/4"	9 - 9,5	14 -16
680501	3/4"	9,5-10	12 -14
680506	3/4"	9,5-10	14 -16
680515	3/4"	10,5-11	14 -16
680517	3/4"	10,5-11	16 -18
680524	3/4"	11,5-12	14 -16
680526	3/4"	11,5-12	16 -18
680535	3/4"	12,5-13	16 -18
680537	3/4"	12,5-13	18 -20
680544	3/4"	13,5-14	16 -18
680546	3/4"	13,5-14	18 -20
680555	3/4"	14,5-15	18 -20
680556	3/4"	15 -15,5	18 -20
680564	3/4"	15,5-16	18 -20
680505	3/4"	17	22,5

**6802 DARGAL**

Compression ends fitting for multilayer pipes with fitting M-F.



Code	
680285	3/4" F - Ø 25x2,5
680296	3/4" F - Ø 26x3



**3475**

Compression fitting, for annealed copper, hard copper, brass, mild and stainless steel pipes. With O-Ring seal.

Code	
347510	3/4" - Ø 10
347512	3/4" - Ø 12
347514	3/4" - Ø 14
347515	3/4" - Ø 15
347516	3/4" - Ø 16
347518	3/4" - Ø 18



**3475..S1**

Compression fitting for annealed copper, hard copper, brass, mild steel and stainless steel pipes. With O-Ring seal. Specific to be used with manifolds 668...S1 series.

Code	
347512S1	3/4" - Ø 12
347514S1	3/4" - Ø 14

3/4" M - Ø 18



Series: 592

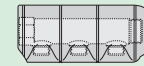

Series: 650

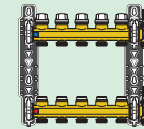

Series: 662

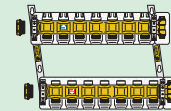

6620

6621

663

6630

6631

666...S1\*

667...S1\*

668...S1\*

664

665

669

657

\* Do not use with copper pipe fittings 347 and 5812 series

1" pipes connection



**6806 DARGAL**

Self-adjustable diameter fitting for single and multilayer plastic pipes.

Code		Ø <sub>inside</sub>	Ø <sub>outside</sub>
680687	1"	17,5	25
680605	1"	19,5	25

1" M - Ø 25



Series: 941

942

We reserve the right to modify our products, make technical improvements and develop them further.  
None of the illustrations, numerical data, etc., are binding.

The products in this price list have been designed, manufactured and marketed in accordance with the Standard EN ISO 9001 Quality Management System.  
Products marked with the "green dot ●" are produced by companies in the Caleffi group.  
Products marked with the "blue dot ●" are commercialised.



**CALEFFI S.p.A.**

S.R.229, N.25 · 28010 Fontaneto d'Agogna (NO) · Italy

Tel. +39 0322 8491

info@caleffi.com | www.caleffi.com

